

## NOTICE

Date: 07.07.2015

All the physics and Electronics opted (for academic year 2015-16) are here by informed to contact to your concerned staff member to prepare and deliver the seminar classes without fail.

Seminar classes are compulsory to all the semester students

Principal

  
Principal,  
S.B.Arts & K.C.P. Sc. College  
Bijapur.

IQAC Co-ordinator

  
IQAC, Co-ordinator  
S.B.Arts & K.C.P.Science College,  
Vijayapur.

HOD

  
Head  
Department of Physics  
S.B.Arts & K.C.P.Science College  
Vijayapur-586103.

2015-16

# Physics Seminar

Name :- Sugnyani. Manu

Sub :- Physics - II

Roll No :- 07

Class :- BSc II<sup>th</sup> sem

Roll No :- S1319758

Seminar topic :- Scattering of light  
(Raman effect)

Head  
Department of Physics  
S.B.Arts & K.C.P.Science College  
Vijayapur-586103.

IQAC, Co-ordinator  
S.B.Arts & K.C.P.Science College,  
Vijayapur.

Principal  
S.B. Arts & K.C.P. Science College  
Bijapur.

# Raman effect :-

In 1928 Sir C.V Raman discovered Experimentally that "when a monochromatic light is allowed to pass through an organic substance like benzene, turpentine the light gets scattered the scattered light contains some additional frequency other than that of incident frequency or original frequency. This is known as Raman effect

## Experimental study of Raman effect :-

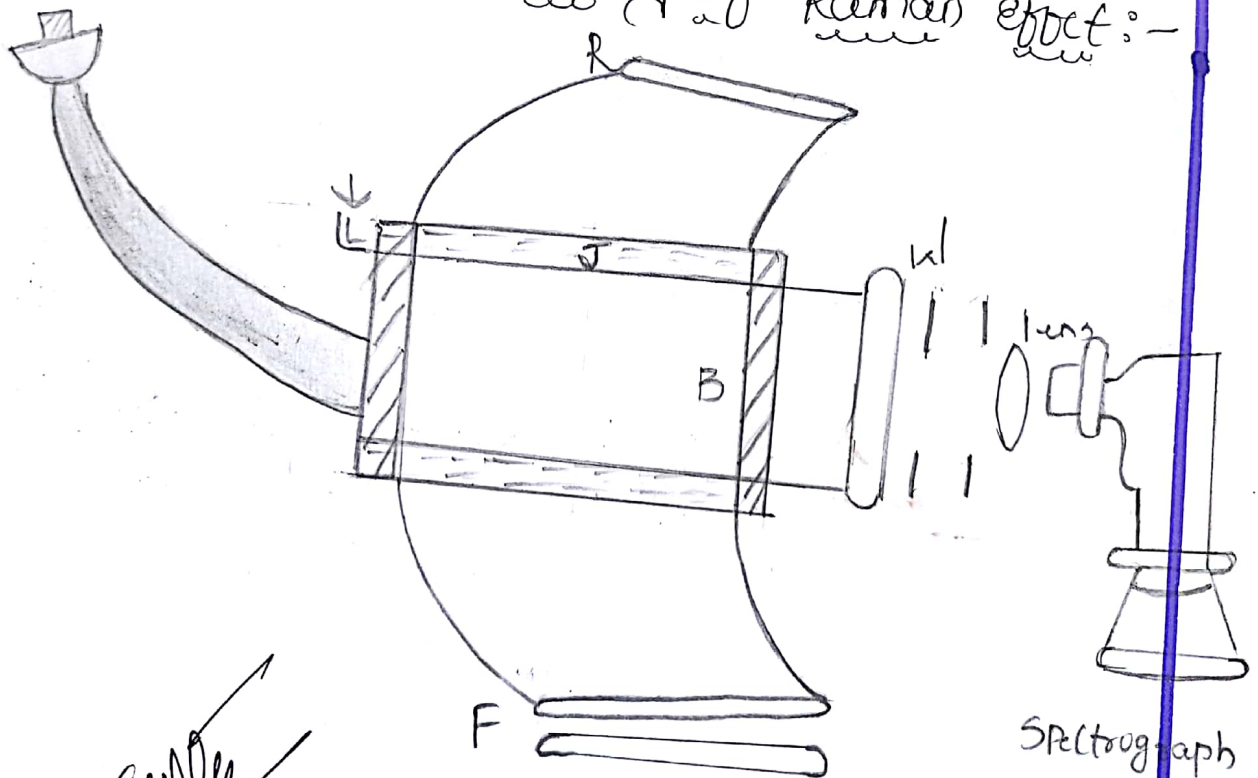

Head  
Department of Physics  
S.B.Arts & K.C.P.Science College  
Vijayapur-586103.

**IQAC, Co-ordinator**

S.B.Arts & K.C.P.Science College.

Principal,  
S.B. Arts & K.C.P. Sc. College  
Bijapur.

**B.L.D.E.ASSOCIATION'S**  
**S. B. ARTS AND K. C. P. SCIENCE COLLEGE VIJAYAPUR**  
**DEPARTMENT OF PHYSICS & ELECTRONICS**

Class: B.Sc VI

Seminar Attendance Sheet

Date: 6-08-2015



Subject: PHYSICS - II

Staff: N.D. Adigonde.

Year: 2015-16

Roll No	RCUB Seat No	Sign	Roll No	RCUB Seat No	Sign
<del>290</del> 72	S1319603	<del>[Signature]</del>	11	S1319901	<del>[Signature]</del>
	S1319604	<del>[Signature]</del>	286	S1319907	<del>[Signature]</del>
231	S1319615	<del>[Signature]</del>	71	S1319910	<del>[Signature]</del>
278	S1319616	<del>[Signature]</del>	149	S1319622	<del>[Signature]</del>
241	S1319623	<del>[Signature]</del>	80	S1319662	<del>[Signature]</del>
237	S1319624	<del>[Signature]</del>	45	S1319654	<del>[Signature]</del>
156	S1319625	<del>[Signature]</del>	64	S1319679	<del>[Signature]</del>
88	S1319647	<del>[Signature]</del>	113	S1319680	<del>[Signature]</del>
70	S1319680	<del>[Signature]</del>	148	S1319702	<del>[Signature]</del>
25	S1319696	<del>[Signature]</del>	7	S1319758	<del>[Signature]</del>
47	S1319754	<del>[Signature]</del>	01	S1319767	<del>[Signature]</del>
141	S1319768	<del>[Signature]</del>	150	S1319776	<del>[Signature]</del>
93	S1319736	<del>[Signature]</del>	142	S1319810	<del>[Signature]</del>
155	S1319779	<del>[Signature]</del>	40	S1319828	<del>[Signature]</del>
48	S1319804	<del>[Signature]</del>	273	S1319797	<del>[Signature]</del>
289	S1319805	<del>[Signature]</del>	132	S1319630	<del>[Signature]</del>
157	S1319813	<del>[Signature]</del>	223	S1319623	<del>[Signature]</del>
20	S1319926	<del>[Signature]</del>	135	S1319675	<del>[Signature]</del>
236	S1319909	<del>[Signature]</del>	166	S1319670	<del>[Signature]</del>
61	S1319942	<del>[Signature]</del>	80	S1319682	<del>[Signature]</del>
165	S1319920	<del>[Signature]</del>	38	S1319648	<del>[Signature]</del>
185	S1319926	<del>[Signature]</del>	51	S1319669	<del>[Signature]</del>

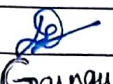
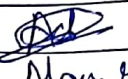
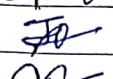
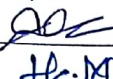
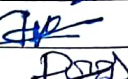
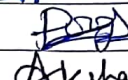
Continued to Page-2

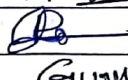
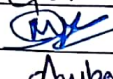
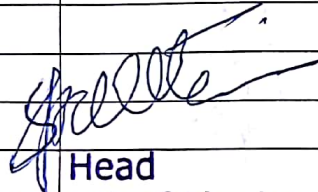
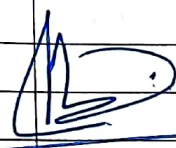
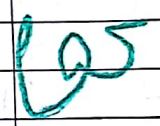
Roll No	RCUB Seat No	Sign	Roll No	RCUB Seat No	Sign
174	S1319785		26	S1319826	
50	S1319786	Gangan.	244	S1319627	Naniff
242	S1319795		230	S1319604	Megha
273	S1319797		126	S1319585	
167	S1319919	H.M.K.	70	S1319680	
76	S1319923		7	S1319758	Akshata
149	S1319622	G.N.	217	S1319755	
93	S1319776		22	S1319771	Gyan
10	S1319781	Ambaji			
					
Head Department of Physics S.B.Arts & K.C.P.Science College Vijayapur-586103.		<b>IQAC, Co-ordinator</b> S.B.Arts & K.C.P.Science College, Vijayapur.			<b>Principal,</b> S.B. Arts and KCP Science College VIJAYAPUR

# Report

Date: 14-03-2016

The department of Physics and Electronics conducted the seminar classes for B.Sc odd and even semester students for the academic year 2015-16 to encourage the students and enhance their language skills.

Principal

  
Principal,  
S.B.Arts & K.C.P. Se. College  
Bijapur.

  
IOAC, Co-ordinator  
IOAC Co-ordinator  
S.B.Arts & K.C.P. Science College  
Vijayapur.

  
Head  
HOD  
Department of Physics  
S.B.Arts & K.C.P.Science College  
Vijayapur-586103.