

Principles of
Organic
Medicinal
Chemistry

Rama Rao Nadendla



NEW AGE INTERNATIONAL (P) LIMITED, PUBLISHERS

Principles of Organic Medicinal Chemistry

**This page
intentionally left
blank**

Principles of Organic Medicinal Chemistry

Prof. RAMA RAO NADENDLA

M.Pharm, Ph.D., FIC

Professor and Principal

Chalapathi Institute of Pharmaceutical Sciences
Chalapathi Nagar, Lam., Guntur - 522034, A.P.



PUBLISHING FOR ONE WORLD

NEW AGE INTERNATIONAL (P) LIMITED, PUBLISHERS

New Delhi • Bangalore • Chennai • Cochin • Guwahati • Hyderabad
Jalandhar • Kolkata • Lucknow • Mumbai • Ranchi

Visit us at www.newagepublishers.com

Copyright © 2005, New Age International (P) Ltd., Publishers
Published by New Age International (P) Ltd., Publishers

All rights reserved.

No part of this ebook may be reproduced in any form, by photostat, microfilm, xerography, or any other means, or incorporated into any information retrieval system, electronic or mechanical, without the written permission of the publisher.
All inquiries should be emailed to rights@newagepublishers.com

ISBN (13) : 978-81-224-2485-0

PUBLISHING FOR ONE WORLD

NEW AGE INTERNATIONAL (P) LIMITED, PUBLISHERS

4835/24, Ansari Road, Daryaganj, New Delhi - 110002

Visit us at www.newagepublishers.com

PREFACE

Principles of Organic Medicinal Chemistry is concerned with chemistry, synthesis, structure activity relationships, properties and uses of drugs of carbon compounds. This book has primarily been written with the aim of meeting the needs and interests of undergraduate and graduate pharmacy course according to syllabi of various Indian Universities. The book is a concise form covering all newer drugs will help the readers to a great extent.

Though several books are available on medicinal chemistry, the material in most of them is present in a diffused form or highly specialized. In the ever expanding knowledge of the chemistry of drugs it is very difficult to go through the various textbooks, journals, and pharmacopoeias. The major objective of writing this book is to present the information in a lucid, condensed and cohesive form, to cater specially the needs of undergraduate and graduate students of pharmacy.

It is impossible to express my indebtedness to those authors of various books, articles and monographs mentioned in bibliography, which became a major source of information for writing this text. I wish to recall my gratitude to Sri Y.V. Anjaneyulu, Chairman, Chalapathi Education Society, Guntur, members of Siddhartha Academy, Vijayawada, staff members of Chalapathi Institute of Pharmaceutical Sciences, Guntur, and Principal and staff members of KVSRR Siddhartha College of Pharmaceutical Sciences, Vijayawada for their kind cooperation. I am also wish to acknowledge indebtedness to all who have assisted with the completion of the book. The cooperation of publishers, Messrs New Age International (P) Limited and publishers is very much appreciated in bringing out this book. The contribution that I received by sustained cooperation of my wife and daughter can't be ignored.

I have made every effort to avoid printing errors. However, despite best efforts, some might have crept in inadvertently. I shall be obliged if these are brought to my notice. Constructive suggestions, comments and criticism on the subject matter of the book will be gratefully acknowledged, as they will certainly help to improve future editions of the book.

It is hoped that the book will be received favorably as an effective text book by both students and teachers of pharmacy, science and medical scientists.

Author

**This page
intentionally left
blank**

CONTENTS

1.	Introduction to medicinal chemistry	1
2.	General principles of drug action	3
3.	Physico chemical properties of organic medicinal agents	14
4.	Chemistry of prodrugs	31
5.	Drug metabolism	41
6.	General anesthetics	52
7.	Sedative-hypnotic drugs	61
8.	Psychoactive drugs	77
9.	Antiepileptic agents	102
10.	Cholinergic and anticholinergic drugs	121
11.	Adrenergic drugs	149
12.	Adrenoreceptor blocking drugs	170
13.	Skeletal muscle relaxants	180
14.	Antihistamines	184
15.	Narcotic analgesics	211
16.	Narcotic antagonists	225
17.	Antitussives	229
18.	Non-steroidal antiinflammatory drugs	232
19.	Local anesthetics	249
20.	Diuretics	259
21.	Hypoglycemic agents	270
22.	Thyroid and antithyroid drugs	282
	<i>Practice Questions</i>	290
	<i>References</i>	315
	<i>Index</i>	317

**This page
intentionally left
blank**

1

Introduction to Medicinal Chemistry

The subject of medicinal chemistry explains the design and production of compounds that can be used for the prevention, treatment or cure of human and animal diseases. Medicinal chemistry includes the study of already existing drugs, of their biological properties and their structure-activity relationships.

Medicinal chemistry was defined by IUPAC specified commission as “it concerns the discovery, the development, the identification and the interpretation of the mode of action of biologically active compounds at the molecular level”.

Medicinal chemistry covers the following stages:

- (i) In the first stage new active substances or drugs are identified and prepared from natural sources, organic chemical reactions or biotechnological processes. They are known as lead molecules.
- (ii) The second stage is optimization of lead structure to improve potency, selectivity and to reduce toxicity.
- (iii) Third stage is development stage, which involves optimization of synthetic route for bulk production and modification of pharmacokinetic and pharmaceutical properties of active substance to render it clinically useful.

Medicinal chemistry is the application of chemical research techniques to the synthesis of pharmaceuticals. During the early stages of medicinal chemistry development, scientists were primarily concerned with the isolation of medicinal agents found in plants. Today, scientists in this field are also equally concerned with the creation of new synthetic compounds as drugs. Medicinal chemistry is almost always geared toward drug discovery and development.

Medicinal chemists apply their chemistry training to the process of synthesizing new pharmaceuticals. They also work on improving the process by which other pharmaceuticals are made. Most chemists work with a team of scientists from different disciplines, including biologists, toxicologists, pharmacologists, theoretical chemists, microbiologists, and biopharmacists. Together this team uses sophisticated analytical techniques to synthesize and test new drug products and to develop the most cost-effective and eco-friendly means of production.

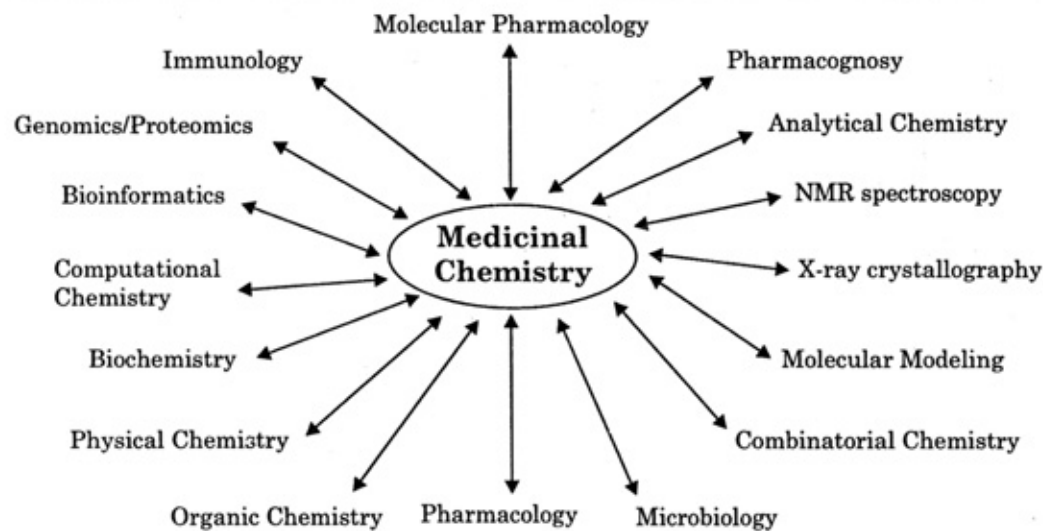

Modern Medicinal Chemistry

The focus on development of new synthetic drug compounds has resulted in the incorporation of many other disciplines, such as biochemistry and molecular biology, into medicinal chemistry. These areas include biology, computer-aided drug design, X-ray crystallography, metabolism and pharmacokinetics, legal and regulatory affairs, clinical, franchise management, pharmaceuticals, and process research chemistry.

2

General Principles of Drug Action

DEFINITION OF DRUGS

A very broad definition of a drug would include “all chemicals other than food that affect living processes.” If the affect helps the body, the drug is a medicine. However, if a drug causes a harmful effect on the body, the drug is a poison. The same chemical can be a medicine and a poison depending on conditions of use and the person using it.

Another definition would be “medicinal agents used for diagnosis, prevention, treatment of symptoms, and cure of diseases.” Contraceptives would be outside of this definition unless pregnancy was considered a disease. All drugs have the potential for producing more than one response. Some adverse drug responses which are unavoidable are appearing at therapeutic doses are termed as side effects. Incontrast, adverse drug effects appearing at extreme drug doses are described as toxic effects.

CLASSIFICATION OF DRUGS

Drugs can be classified according to various criteria:

1. By origin—sources of drugs

Drugs may be obtained from 1. Plants 2. Animals 3. Minerals or 4. Microorganisms. The drugs may also be semisynthetic or synthetic compounds. The sources of drugs are summarized as follows:

A. Synthetic. Most of the drugs in use today are synthetic in origin. Such drugs are chemically pure and it is easy to maintain supply line.

Ex. : Aspirin, Paracetamol.

B. Natural. There are number of natural sources. They are:

- (a) **Plants.** A number of plant based drugs such as vincristine, taxol, digoxin, quinine, reserpine, ergotamine, ephedrine, colchicine etc. are still a part of standard therapy. Most of these don't have any synthetic substitutes. Several other plant products are used in formulations that are sold across the counter in several countries.
- (b) **Animal.** Some modern drugs continue to be derived from animal sources because the synthesis of such chemicals is very cumbersome and expensive. Ex. : Gonadotrophins, heparin, insulin, thyroid extracts and enzymes.
- (c) **Microorganisms.** Following the accidental discovery of penicillin from a mould in 1928 and its successful use in chemotherapy in 1940, a large number of antibiotics

have been discovered from a variety of soil fungi and some bacteria. These drugs form the most important group of chemotherapeutic agents used against infective diseases. Ex. : Penicillin, Streptomycin, Tetracycline.

(d) **Minerals.** Minerals or mineral-containing medicated *springs* have been in use since time immemorial. Several such hot water springs with medicinal value are popular in India. Ex. : Rajgrin (Bihar), Sahashradhara (Dehradun). Minerals of medicinal value are iron, calcium, magnesium, aluminium, sodium, potassium etc.

C. Semi-synthetic. In some cases, especially with complex molecules, the synthesis of a drug may be very difficult or expensive and uneconomical. At the same time, the ones derived from natural sources may be impure. In these cases semisynthetic processes are used.

Ex. : 6-Aminopenicillanic acid is obtained from the fungus *Penicillium chrysogenum*.

D. Biosynthetic. Several drugs are complex polypeptides. It is difficult to obtain these drugs in pure form from natural sources and are very expensive to synthesize in the laboratory.

Ex: Biosynthetic human insulin, interferon, erythropoietin, hepatitis vaccine.

Amongst all these, synthetic drugs are used most widely because of their inexpensiveness, ease of quality control, mass production and therapeutic efficacy. The synthetic drugs are prepared by chemical processes.

Ex: Chloroquine, acetylsalicylic acid, chlorpromazine, ephedrine etc.

2. By Action

According to similarity of drug effects: Ex: marijuana and atropine both increase heart rate and cause dryness of the mouth. Thus, marijuana would be classified as atropine-like drug.

3. By therapeutic use

These drugs mainly affect the normal dynamic processes of the body. They are;

- (i) Anti-arrhythmics
- (ii) Antianginals
- (iii) Vasodilators
- (iv) Anti-hypertensives
- (v) Cardiotonics
- (vi) Hypocholesteric agents
- (vii) Antiallergic agents
- (viii) Drugs acting on GIT
- (ix) Drugs influence renal function
- (x) Drugs acting on central nervous system
- (xi) Drugs acting on peripheral nervous system

4. By site of drug action

Ex: Alcohol is a depressant drug because of its depressant CNS action. This system is limited when a drug has an effect at several body sites (e.g., the CNS stimulant cocaine also has local anesthetic (pain reducing) effects).

5. By Chemical Structure

Drugs are classified according to the chemical moiety or functional group. They may be further subclassified as:

- (i) Hydrocarbons
- (ii) Halogenated compounds
- (iii) Alcohols
- (iv) Carboxylic acids
- (v) Phenols
- (vi) Nitro compounds
- (vii) Amides
- (viii) Amines
- (ix) Sulphonamides, sulphones, stilbenes, thioureas, ureides etc.

CHARACTERISTICS OF DIFFERENT ROUTES OF DRUG ADMINISTRATION

Most drugs can be administered by a variety of routes. The choice of appropriate route in a given situation depends both on drug as well as patient related factors. Drugs may be administered locally or systemically. The drugs administered through systemic routes are intended to be absorbed into blood and distributed all over the body.

1. Oral/swallowed. Oral ingestion is the oldest and commonest mode of drug administration. Most drugs in this route of administration are absorbed in small intestine. Full stomach delays absorption (e.g. alcohol). Several drugs may be subject to first-pass metabolism by liver (*Ex:* Aldosterone, cortisol, acetyl salicylic acid). The drug candidates may undergo extensive metabolism before reaching target receptors. It is safer, more convenient, noninvasive, often painless, the medicament need not be sterile and so cheaper. Both solid dosage forms and liquid dosage forms can be given orally.

2. Oral/sublingual. The tablet or pellet containing the drug is placed under the tongue or crushed in the mouth and spread over the buccal mucosa. In this mode of administration fast systemic absorption is observed which, bypass gastrointestinal tract entry. It avoids absorption and first-pass metabolism in the liver and is useful for those likely to vomit from swallowed medication.

3. Rectal. Here the drugs are absorbed directly from the rectum. It partially avoids first-pass metabolism by liver and also for those likely to vomit and lose swallowed medication. Certain irritant and unpleasant drugs can be put into rectum as suppositories or retention enema for systemic effect. *Ex:* Aminophylline, indomethacin, paraldehyde, diazepam, ergotamine, and few other drugs are some times given rectally.

4. Epithelial. In this technique drugs are absorbed through the skin. This route is useful for those likely to vomit (e.g. nicotine patch). Highly lipid soluble drugs can be applied over the skin for slow and prolonged absorption. The drug bypasses the liver by this route of administration. The drug can be incorporated in an ointment and applied over specified area of skin.

5. Inhalation. Volatile oils and gases are given by inhalation ex: general anesthetic, amyl nitrite. The drugs enter the bloodstream very rapidly from the lungs. Here no absorption or first-pass metabolism problems occur. This route is potentially dangerous because it is so fast and direct.

6. Parenteral Route. Parenteral administration refers to administration by injection into tissue fluid or blood without having to cross the intestinal mucosa. This route can be employed even in unconscious, uncooperative or vomiting patient. The important parenteral routes are subcutaneous (SC); intramuscular (IM); intravenous (IV). The rate of absorption depends on blood flow through injection site. SC or IM exert effects more quickly than oral administration. IV is the fastest route and most certain in terms of obtaining desired concentration of drug in blood plasma.

SITES OF DRUG ACTION

1. Enzyme inhibition. Drugs act within the cell by modifying normal biochemical reactions. Enzyme inhibition may be reversible or non-reversible; competitive or non-competitive. Antimetabolites may be used which mimic natural metabolites.

2. Drug-Receptor interaction. Drugs act on the cell membrane by physical and/or chemical interactions. This is usually through specific drug receptor sites known to be located on the membrane. A receptor is the specific chemical constituents of the cell with which a drug interacts to produce its pharmacological effects. Some receptor sites have been identified with specific parts of proteins and nucleic acids. In most cases, the chemical nature of the receptor site remains obscure.

3. Non-specific interactions. Drugs act exclusively by physical means outside of cells. These sites include external surfaces of skin and gastrointestinal tract. Drugs also act outside of cell membranes by chemical interactions. Neutralization of stomach acid by antacids is a good example

MODE OF DRUG ACTION

It is important to distinguish between actions of drugs and their effects. Actions of drugs are the biochemicals, physiological mechanisms by which the chemical produces a response in living organisms. The effect is the observable consequence of a drug action. For example, the action of penicillin is to interfere with cell wall synthesis in bacteria and the effect is the death of bacteria.

One major problem of pharmacology is that no drug produces a single effect. The primary effect is the desired therapeutic effect. Secondary effects are all other effects beside the desired effect which may be either beneficial or harmful. Drugs are chosen to exploit differences between normal metabolic processes and any abnormalities, which may be present. Since the differences may not be very great, drugs may be nonspecific in action and alter normal functions as well as the undesirable ones, this leads to side effects.

The biological effects observed after a drug has been administered are the result of interaction between that chemical and some part of the organism. Mechanisms of drug action

can be viewed from different perspectives, namely, the site of action and the general nature of the drug-cell interaction.

1. Killing foreign organisms. Chemotherapeutic agents act by killing or weakening foreign organisms such as bacteria, worms, and viruses. The main principle of action is selective toxicity, i.e. the drug must be more toxic to the parasite than to the host.

2. Stimulation and depression. Drugs act by stimulating or depressing normal physiological functions. Stimulation increases the rate of activity while depression reduces it.

3. Irritation. It is a non-specific action of a drug that can occur in all the body tissues. Certain drugs act by causing irritation. Ex: Drugs like senna and castor oil show their laxative effects by their irritant action on gastrointestinal tract.

4. Replacement. Drugs serve as replacement of essential body chemicals that are either absent or present in less than required quantity due to disease. Ex: Insulin is used in diabetes. Levodopa therapy in Parkinson's disease.

MECHANISM OF DRUG ACTION

A drug act by virtue of its various properties like physical, chemical, physiological etc. The fundamental mechanisms of drug action can be distinguished into following categories.

1. Physical Properties

A physical property of the drug is responsible for its action.

- (i) **Taste.** Bitter taste drugs increase the flow the hydrochloric acid reflexly in the stomach. Ex: Quassia, Chirata
- (ii) **Mass.** By increasing the bulk of drug in intestine produce laxative effect. Ex: Isapgol
- (iii) **Adsorption.** Certain drugs like kaolin adsorb water on to its surface and there by reduce gastric motility
- (iv) **Radioactivity.** The radioactive substances are commonly used to treat cancer. Ex: 125.

2. Chemical Properties

The drugs react extracellularly according to simple chemical reactions like neutralization, chelation, oxidation etc. Ex:

- (i) Aluminium hydroxide neutralizes acid in stomach
- (ii) Toxic heavy metals can be eliminated by chelating agents like EDTA, BAL, penicillamine etc.
- (iii) Oxidising agents are germicidal.

3. Through Enzymes

Enzymes are very important targets of drug action because almost all biological reactions are carried out under the influence of enzymes. Drugs may either increase or decrease enzymatic reactions. Ex:

- (i) Adrenaline stimulates adenylyl cyclase
- (ii) Pyridoxine acts as a cofactor and increases decarboxylase activity

(iii) Allopurinol competes with hypoxanthine for xanthine oxidase

(iv) Physostigmine and neostigmine compete with acetylcholine for cholinesterase.

4. Through Receptors

A large number of drugs act through specific macromolecular components of the cell, which regulate critical functions like enzymatic activity, permeability, structural features, template function etc. These macromolecules, which bind and interact with the drugs, are called receptors.

DRUG-RECEPTOR INTERACTIONS

Introduction

The concept of proteins as drug targets is not novel and was suggested at the end of the 19th and the beginning of the 20th centuries. Ehrlich and Langley both contributed the idea that compounds displayed biological activity by binding to cellular constituents (Ehrlich: 'corpora non agunt, nisi fixata', which tells us that 'agents do not work, unless bound') that were soon named 'receptors' (Langley: 'receptive substances'). One could consider that every protein that acts as the molecular target for a certain drug should be called a receptor. A receptor is a component of a cell or organism that interacts with a drug and initiates the chain of biochemical events leading to the drug's observed effects.

Drug-Receptor Complex Nomenclature

1. **Agonist**—A drug that activates a receptor is known as an agonist, which has following properties;
 - Agonists can differ in both affinity and efficacy for the receptor
 - High efficacy agonists are full agonists because they elicit maximal effects
 - Low efficacy agonists are partial agonists because they cannot elicit a maximal effect at receptors even at high concentrations (false transmitters)
 - Direct agonists act on receptors, while indirect agonists facilitate the actions of the endogenous agonist (the neurotransmitter, itself)
2. **Antagonist**—A drug that does not activate the receptor is an antagonist, which possess the following features ;
 - Antagonists also prevent the activation of the receptor by an agonist, thus antagonists are essentially zero efficacy drugs
 - Competitive antagonists bind to the same binding site as the agonist and therefore compete with the agonist for that binding site
 - Non-competitive antagonists have a different binding site to the agonist and therefore do not compete with the agonist. Some non-competitive antagonists have a binding site within the ion channel associated with the receptor complex.

Chemical Nature of Receptors

For many years receptors, remained hypothetical structures, until in the 1970s the development of radioactive ligand led to the visualization and quantification of binding sites for drugs in tissues or isolated cells. Nowadays, structural information (X-ray, NMR) of a

variety of receptor proteins is known and this has led to the development of detailed insights in the molecular processes involved in drug-receptor interactions.

Receptors are no longer hypothetical. Hundreds of receptor proteins have been isolated, purified, cloned, and their primary amino acid sequence has been established. It has been possible to study the receptor by binding assay, biochemical characterization, immunological characterization and molecular biological characterization.

Most of the receptors like regulatory enzymes (dihydrofolate reductase enzyme) acetylcholinesterase transport proteins and structural proteins (Tubulin) are protein in nature and some are glycoproteins (G-protein coupled receptors) or nucleic acids.

Types of Receptors

However, the overall structure of receptor proteins is often not so divergent, suggesting that signal transmission via receptor proteins is governed by a limited number of basic mechanisms that are utilised in an extremely efficient way. One distinguishes four super-families of receptor proteins, which cover most of the relevant receptor proteins. These four receptor families are:

(i) **Ligand-gated ion channels.** Ligand-gated ion channels, which are membrane-bound receptors, directly linked to an ion channel. They are also known as ionotropic receptors. Examples include the nicotine acetylcholine receptor, glutamate receptor and the GABA-A receptor.

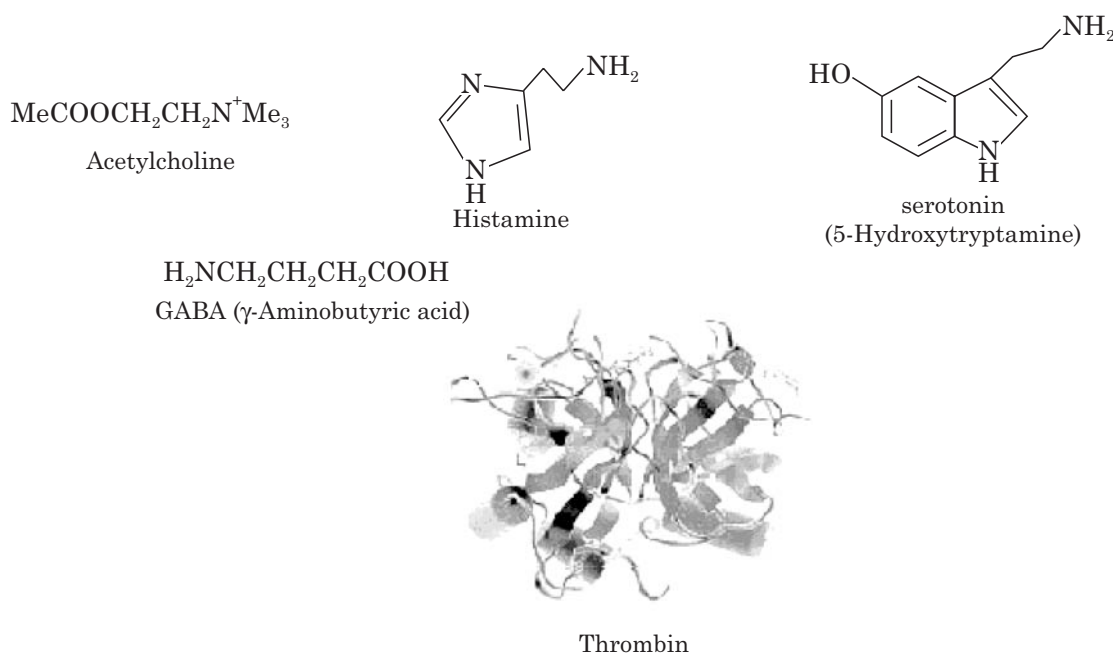

Structures of selected ligands for G-protein coupled receptors.

(ii) **G-protein (Guanine nucleotide-regulatory protein) coupled receptors.** G-protein coupled receptors, which are membrane-bound receptors coupled to G-proteins. After

activation of the G-proteins a variety biochemical signal transduction pathways can be activated. Many chemical messengers, like hormones and various neurotransmitters, act through G-protein coupled receptors. They are also known as metabotropic receptors or 7-transmembrane receptors. Ex: Muscarinic acetylcholine receptors and adrenergic receptors.

(iii) **Tyrosine Kinase-linked Receptors.** Tyrosine kinase-linked receptors, are membrane bound receptors and contain an intrinsic enzymatic function (tyrosine kinase activity) in their intracellular domain. Upon combination with ligand like insulin, the receptor is activated and is able to phosphorylate tyrosine residues of other intracellular proteins. Protein phosphorylation is one of the underlying mechanisms of the regulation of protein function. Ex: Receptors for insulin and various cytokines and growth factors.

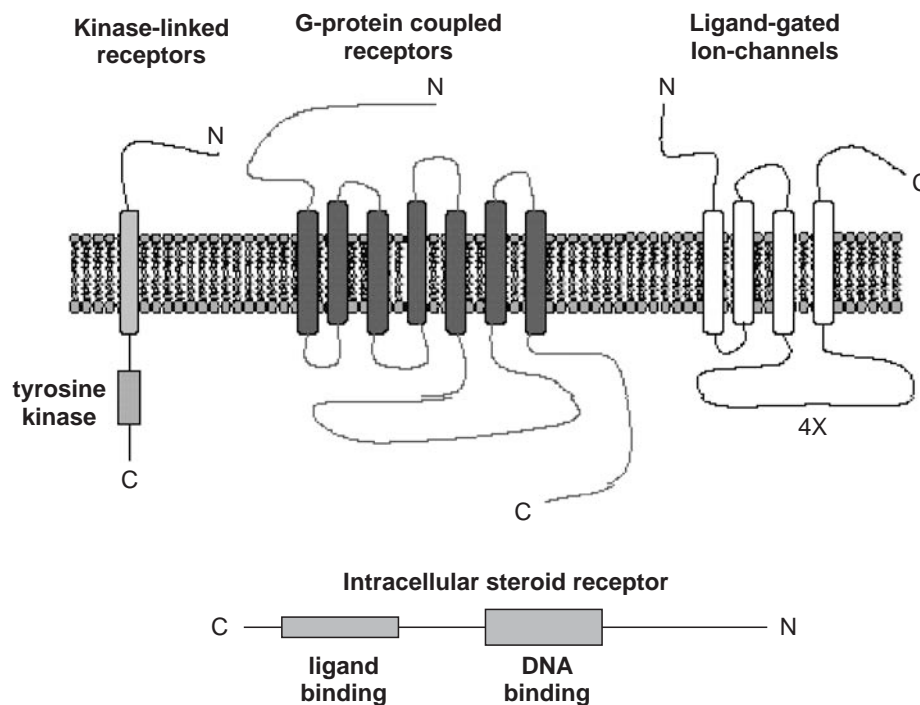

Schematic representation of the four major classes of receptor proteins. Except for the steroid receptors, the receptor proteins are localised in the cell membrane. The ligand-gated ion channels are made up of an assembly by 4-5 subunits, which each contain four transmembrane domains.

(iv) **Intracellular receptors regulating gene transcription:** Intracellular receptors regulating gene transcription, which are located in the cytosol. Upon binding of the appropriate chemical e.g. steroid hormones, the activated receptors translate to the nucleus and initiate gene transcription. These are also known as nuclear receptors. Ex: Receptors for steroid hormones, thyroid hormones and vitamin D.

Drug Receptor Interactions

Majority of drugs show remarkably high correlation of structure and specificity to produce pharmacological effects. A minimum three-point attachment of a drug to a receptor site is

required. In most cases specific chemical structure is required for the receptor site and a complementary drug structure. Slight changes in the molecular structure of the drug may drastically change specificity. To initiate a biological response, the drug must form bond with the receptor surface. Different types of binding forces that may exist in drug-receptor interactions are as follows:

(i) **Covalent interactions.** These chemical forces may result in a temporary binding of the drug to the receptor. Frequently, a covalent bond is firm and described as essentially “irreversible” under biological conditions. Since by definition the drug-receptor interaction is reversible, covalent bond formation is rather rare except in a toxic situation. Examples:

- (a) A covalent bond is formed between the activated form of phenoxybenzamine (α -adrenergic receptor antagonist)
- (b) Antineoplastic or antibiotic drugs act mainly through the formation of covalent bonds
- (c) The DNA-alkylating chemotherapeutic agents are chemically highly reactive, forming covalent bonds with DNA functional groups. Such covalently modified DNA may be incompatible with successful tumor cell division

(ii) **Ionic interactions.** Since many drugs contain acid or amine functional groups, which are ionized at physiological pH. Ionic bonds are formed by the attraction of opposite charges in the receptor site with the ionized groups of the drug molecule. They are strong electrostatic interactions (5-10 kcal/mol) and are responsible for relative orientation of the drug to its binding site. Electrostatic interactions tend to be much more common than the covalent bonding in drug-receptor interactions. Attraction between ions of opposite charge is inversely proportional to the square of the distance between them. Strong electrostatic interactions occur between permanently charged ionic molecules. The overall contribution of ionic interactions may be overemphasized due to desolvation. Ionic bonds have a relatively high stability.

Ex: In acetylcholine molecule, the positively charged quaternary nitrogen may be attracted to the negative charged ionized carboxyl group present in the receptor site.

(iii) **Hydrogen bonding interactions (non-ionic/neutral).** Polar-polar interactions are the attraction of opposite charges. The drug-receptor reaction is essentially an exchange of the hydrogen bond between a drug molecule, surrounding water, and the receptor site. The hydrogen bond strength is distance dependent may range from 5 – 7 kcal/mol, depending on the binding environment.

(iv) **Vander Waals interaction.** These forces have the following characteristic features:

- (a) Interactions at a close range
- (b) The Vander Waals interaction forces occur less frequently than hydrophobic forces
- (c) Interactions are much weaker (~ 0.5 -1 kcal/mol) than other electrostatic interactions
- (d) Close contacts (attractive forces) over a large surface area i.e. at the interface of ligand and binding site, may contribute to binding
- (v) **Hydrophobic/Lipophilic interactions.** Finally hydrophobic bonds are formed between non-polar hydrocarbon groups on the drug and those in the receptor site. These bonds are not very specific but the interactions do occur to exclude water molecules.

Most of the drug molecules have a non-polar portion (alkyl or aryl groups) which may combine with non-polar portion of the receptor site through hydrophobic forces. Hydrophobic interactions are generally weak, but important. Hydrophobic interactions are probably significant in driving interactions

- (a) Between lipophilic drugs and the lipid component of biological membranes
- (b) Between drugs and relatively nonpolar (non charged) receptor regions

Receptor site theories

After attachment of drug molecule to a receptor site, a drug may either initiate a response or prevent a response from occurring.

This concept can be easily understood if one considers the 'lock-and-key' principle for ligand–receptor interaction. Only keys (ligands) that fulfil all criteria for fitting into the lock (receptor) can open the door (produce an effect). Some keys can fit in the lock but not perfectly, consequently they cannot open the door yet. By fitting into the lock, these keys prevent the original key from fitting into the lock and opening the door. The concept of receptor antagonism is extremely important in medicinal chemistry and is very often the underlying mechanism of drug action e.g. to prevent the constriction of airway smooth muscle in asthmatic conditions one can administer receptor antagonists that prevent the actions of the signalling molecules causing muscle contraction (e.g. histamine and leukotriene antagonists).

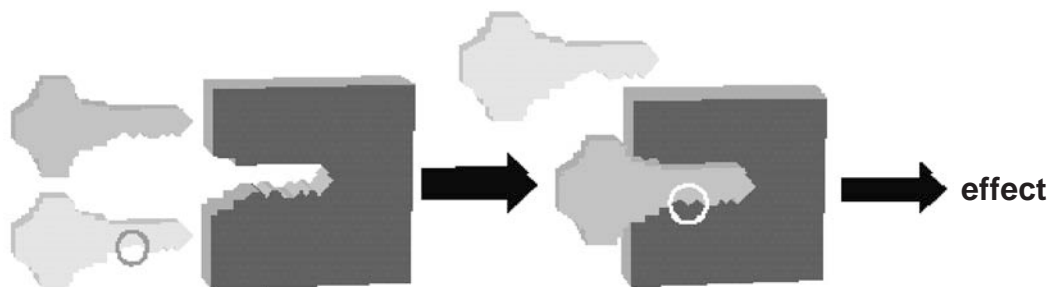

Lock-and-key principle for receptor–ligand interactions. Only one of the keys (ligands) fits perfectly into the lock (receptor) and will be able to open the lock (give a response). The small difference between the two keys is indicated by the circle. The 'imperfect' key will fit in the lock, but is not able to open the lock. By sitting in the lock the imperfect key prevents the perfect key getting into the lock. One could regard an antagonist as an imperfect key and a receptor agonist as the perfect key.

(i) **Occupation theory.** In fact, similar mathematical models have been applied to the receptor–ligand interaction. Clark's occupation theory was the first model that could describe the observations of drug action on isolated tissues. In this theory the receptor–ligand interaction is considered to be a bimolecular interaction, in which the receptor–ligand complex is responsible for the generation of the biological effect. Clark assumed that the effects of a drug were proportional to the fraction of receptors occupied by the drug. Consequently, for a maximal effect the drug has to occupy all receptors. In Clark's theory, the agonist (A) interacts in a reversible way with the receptor (R) and the formed complex (AR) gives rise to the effect:



In equilibrium, the rate of the forward reaction of an agonist A reversibly bound to its receptor R is proportional to the concentration of A and R, and the proportionality constant is denoted by k_1

$$\text{rate of association} = k_1[A][R]$$

Similarly, the rate of the backward reaction, in which the agonist–receptor complex dissociates again, is proportional to the concentration of the AR complex

$$\text{rate of dissociation} = k_2 [AR]$$

At equilibrium the rate of the forward reaction equals the rate at which existing AR complexes dissociate i.e. $k_1[A][R] = k_2[AR]$. In other words, within a certain period of time the same number of molecules A will bind to and dissociate from the receptor. At equilibrium the dissociation constant K can be described as follows:

$$K = \frac{k_1}{k_2} = \frac{[A][R]}{[AR]}$$

(ii) **Rate theory.** Rate theory was proposed by Paton and Rang in 1965. According to this theory the most important factor in determining drug action is the rate at which drug receptor combination takes place. The rate theory can be explained by the formula:

$$\text{Rate of receptor occupation} = \frac{k_2}{1 + \frac{KA}{[A]}}$$

(iii) **Induced-fit theory.** This theory states that after combination, the substrate induces a change in conformation of the enzyme, leading to an enzymatically active orientation of groups. Ex: Acetylcholine may interact with the regulating protein and alter the normal forces. Macromolecular perturbation theory and activation-aggregation theories are the extension of induced fit theory.

3

Physico-chemical Properties of Organic Medicinal Agents

At the most fundamental level, the ability of a chemical compound to elicit a pharmacological/therapeutic effect is related to the influence of various physical and chemical (*physico-chemical*) properties of the chemical substance on the biomolecule(s) that it interacts with. Among the most pharmacologically influential physico-chemical properties of organic medicinal agents are;

1. Solubility
2. Partition coefficient
3. Dissociation constant (pKa)
4. Hydrogen bonding
5. Molar refractivity (MR)
6. Ionization
7. Drug shape
8. Complexation
9. Surface activity
10. Protein binding
11. Bioisosterism.

SOLUBILITY

The solubility of a substance at a given temperature is defined as the concentration of the dissolved solute, which is in equilibrium with the solid solute. Solubility depends on the solute and solvent as well as temperature, pressure, and pH. The solubility of a substance is the ratio of these rate constants at equilibrium in a given solution.

The solubility of an organic medicinal agent may be expressed in terms of its *affinity/philicity* or *repulsion/phobicity* for either an aqueous (hydro) or lipid (lipo) solvent.

$$K_{\text{SOLUBILITY}} = \frac{k_{\text{SOL}}}{k_{\text{PPT}}}$$

The atoms and molecules of all organic substances are held together by various types of bonds (*e.g.* London forces, hydrogen bonds, dipole-dipole, etc.). These forces are intricately involved in solubility because it is the solvent-solvent, solute-solute, and solvent-solute interactions that govern solubility.

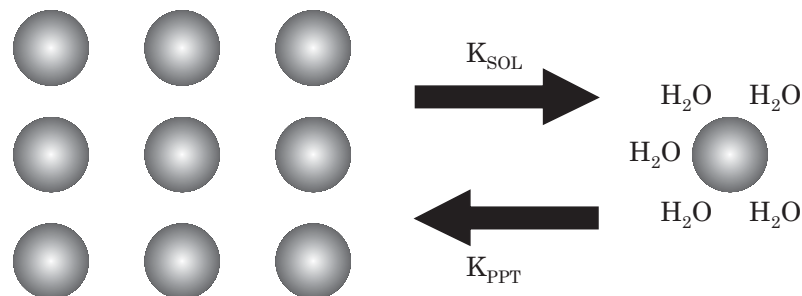

The most important intermolecular attractive forces (bonds) that are involved in the solubilization process are;

1. Vander Waals attraction (induced dipole). They are weakest intermolecular forces (0.5–1.0 kcal/mole) which occur between nonpolar groups (*e.g.* hydrocarbons). They are highly distance and temperature dependent.

2. Dipole-Dipole Bonding. These forces occur when electronegative elements are attached to carbon. They are stronger (1.0 to 10 kcal/mole) and occur electrostatically between electron deficient and electron rich atoms (dipoles). Hydrogen bonding is a specific example of this bonding and serves as a prime contributor to hydrophilicity.

3. Ionic Bonding. Ionic bond is electrostatic attraction between cations and anions. These ionic attractions are common in inorganic compounds and salts of organic molecules and are relatively strong (5 kcal/mole).

Probably the most important factor in the prediction of water solubility in ionic drugs is their ability to ionize. The degree of ionization of a drug is by far the best predictor of solubility for most compounds, which are acidic or basic.

4. Ion-Dipole Bonding. This is electrostatic force between a cation/anion and a dipole. It is relatively strong (1-5 kcal/mole) and is low temperature and distance dependent. Ion-dipole bonding is an important attraction between organic medicinal agent and water.

Hence, the relative solubility of an organic medicinal agent is a function of the presence of both lipophilic and hydrophilic features within its structure, which serve to determine the extent of interaction of the organic medicinal agent with lipid and/or aqueous phases.

Methods to Improve the Solubility of Drugs

1. Structural Modifications

- (a) One method to increase solubility of a drug is to alter the chemical structure of the molecule. The addition of polar groups like carboxylic acids, ketones and amines can increase solubility by increasing hydrogen bonding and the interaction with water.
- (b) Another structural modification can be to reduce intramolecular forces. An example of structural modification to enhance solubility by this method is methyl dopa (solubility ~10 mg/ml) and methyl dopate (solubility 10-300 mg/ml) depending on pH. The addition of the ethyl ester to methyl dopa reduces the intramolecular hydrogen bond between the carboxylic acid and primary amine. Therefore, this addition reduces the melting point and increases solubility.

- (c) *Use of Co-solvents.* Another method to increase solubility is the use of co-solvents. The co-solvents can increase solubility by several orders of magnitude. Some commonly used co-solvents are propylene glycol, polyethylene glycol, ethanol and sorbitol. The addition of a co-solvent can increase solubility of hydrophobic molecules by reducing the dielectric constant of the solvent. Some problems with the use of co-solvents are precipitation of the drug with dilution of solvent mixture and tissue damage or pain upon injection. This dilution occurs after administration of the drug into the body.
- (d) *Employing surfactants.* Surfactants can also be used to enhance solubility. A surfactant or surface active agent is amphiphilic, meaning it has polar end (the circular head) and a nonpolar (the tail). When a surfactant is placed in water it will form micelles. A nonpolar drug will partition into the hydrophobic core of the micelle and will get solubilized.
- (e) *Complexation.* There are many types of complexing agents. Complexation relies on relatively weak forces such as London forces, hydrogen bonding and hydrophobic interactions. As the concentration of complexing agent is increased, so is the solubility, up to a point. In some cases however, the complex can precipitate out from solution as the concentration of complexing agent is increased.

Importance of Solubility

- (a) The concept of solubility is not only important to a pharmacist because it governs the preparation of solutions as a dosage form but also because a drug must be in solution before it can be absorbed by the body or have any biological activity.
- (b) Drugs must be in solution to interact with receptors. Drugs have some degree of solubility in both aqueous and lipid compartments. In order for a chemical compound to dissolve in a particular solvent/medium the compound must establish attractive forces between itself and molecules of the solvent. Hence, it is possible to estimate the solubility properties of an organic medicinal agent (hydrophilic vs. lipophilic) by examining the structure of the organic medicinal agent and noting whether its structural features promote affinity for aqueous or lipid media.

PARTITION COEFFICIENT

The ability of a drug to dissolve in a lipid phase when an aqueous phase is also present, often referred to as lipophilicity. The lipophilicity can be best characterized by partition coefficient. Partition coefficient can be defined as the equilibrium constant of drug concentrations for “unionizable” molecules in the two phases:

$$P = \frac{[\text{drug}]_{\text{lipid}}}{[\text{drug}]_{\text{water}}}$$

and for “ionizable” molecules (acids, bases, salts), where alpha (α) is the degree of ionization in aqueous solution. It is basically a constitutive property.

$$P = \frac{[\text{drug}]_{\text{lipid}}}{(1 - \alpha)[\text{drug}]_{\text{water}}}$$

Naturally, the partition coefficient is one of the several physicochemical parameters influencing drug transport and distribution. The contribution of each functional groups and their structural arrangement help to determine the lipophilic or hydrophilic character of the molecule. Partition coefficient majorly influence drug transport characteristics; the way in which the drugs reach the site of action from the site of application (*e.g.* injection site, gastrointestinal tract, and so forth). Since the blood distributes drugs, they must penetrate and traverse many cells to reach the site of action.

Compound	Lipid/water partition coefficient
Ethanol	0.03
Morphine	0.40
Barbitone	1.40
Phenobarbitone	5.90

Phenobarbitone has a high lipid/water partition coefficient of 5.9. Thiopentone sodium has a chloroform/water partition coefficient of about 100, so it is highly soluble in lipid and can easily pass through blood brain barrier.

Partition coefficient measurement

Since partition coefficients are difficult to measure in living systems, they are usually determined *in vitro* using 1-octanol (n-octanol) as the lipid phase and a phosphate buffer of pH 7.4 as the aqueous phase. The partition coefficient, P is dimensionless, and its logarithm (log P) is widely used as the measure of lipophilicity. The LogP is determined by following methods:

(i) **Log P by shake flask.** The shake flask method is the oldest and most tedious way of measuring log P values. The UV absorbance of an aqueous solution is measured before and after being shaken with a known volume of octanol. The method is messy and smelly but is the only method that can be used in cases of very low Log P values. One advantage of the method is that the appearance of compound in the octanol may be checked against the disappearance from the aqueous phase to see if any surface effects have occurred. Some molecules may form effective surfactants. It is very important to pre-saturate the solvents in prolonged shake-flask experiments. The experiment must be performed over 3 days or more to ensure equilibrium is reached, although the actual time taken in doing the experiment is about 0.5 day.

(ii) **Log P by HPLC.** HPLC may be used to estimate Log P values. Compounds with known Log P's are injected onto a C18 reverse phase HPLC column to create a calibration curve. Unknown compounds are then injected to predict Log P. Strictly this technique is only valid for neutral molecules. Charged molecules have far more complex retention behaviour than simple partition.

The chromatographic methods suffer the disadvantage that the retention time is linearly related to the partition coefficient, *i.e.* for a doubling of the LogP, there is a tenfold increase in the retention. This often requires different length columns to be used, short ones for high LogP values and long ones for low values.

Relationships between Log P and activity

The partition coefficient is also a very useful parameter that may be used in combination with the pKa to predict the distribution of a drug compound in a biological system. Factors such as absorption, excretion and penetration into the CNS may be related to the Log P value of a drug. Drugs should be designed with the lowest possible Log P, to reduce toxicity, non-specific binding, increase ease of formulation and bioavailability.

Relationships between Log P and activity are often found in series where structural modifications have not significantly affected the pKa values. Hansch in 1964 showed that these relationships were often parabolic hence the relationship often leads to an optimum value for the log P for a desired activity or selective distribution. Relationships of the following types are generated using regression analysis to correlate observed biological activity with measured partition coefficients.

$$\text{Activity} = m \log P + k' \text{ (linear)}$$

$$\text{Activity} = m \log P - c(\log P)^2 - k \text{ (parabolic)}$$

$$\text{Activity} = m \log P - c(\log P + 1) - k \text{ (rectilinear) (where } m, k \text{ and } c \text{ are constants)}$$

The best way of relating LogP, pKa and other physico-chemical properties to biological activity is using multivariate techniques such as Principal Components Analysis and Partial Least Squares regression.

DISSOCIATION CONSTANTS

The dissociation constant is one of the most important characteristics of a pharmaceutical compound. Majority of drugs are weak acids or weak bases and like acetic acid or ammonia, they react with water to form conjugate pairs. The pKa or 'Dissociation constant' is a measure of the strength of an acid or a base and is sometimes called the acidity constant or the ionization constant. It is a numerical representative of the relative proton transfer for that substance, or the likelihood of that compound donating a proton. It is calculated in the same fashion as the equilibrium constant.

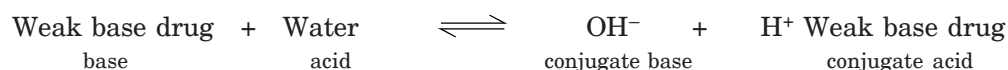
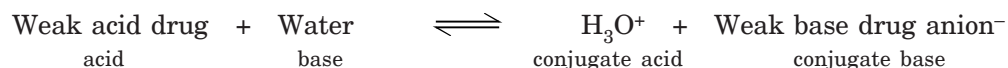

Let us consider equation for the protolysis of water by an acidic drug (HA).

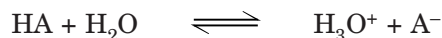

At equilibrium, the velocity of the reaction proceeding to the ionized components (k_1) is equal to the velocity of the reaction resulting in the unionized HA and H₂O (k_2).

$$(k_1) = [\text{HA}][\text{H}_2\text{O}]$$

$$(k_2) = [\text{H}_3\text{O}^+][\text{A}^-]$$

Weakly acidic and basic drugs ionize only slightly in the presence of water. That being the case, the concentration of water in the above equation may be taken as a constant, by rearranging the equation to yield:

$$K_a = k_2 (55.53)/k_1 = [\text{A}^-][\text{H}_3\text{O}^+]/[\text{HA}]$$

where 55.53 is the number of moles of water per liter at 25°C.

This value, K_a , gives us numeric value to express the degree to which a compound ionizes, or dissociates, in aqueous solution. Dissociation constants are determined by experimental data, and are unique to each molecule. Conductivity, freezing point depression, pH of solution, and spectrophotometric data may be used to determine a compound's dissociation constant.

Ex: Acetaminophen is an acidic drug with a K_a of 1.2×10^{-10} , and is thus much less likely to ionize in aqueous solution than aspirin (acetyl salicylic acid), which has a k_a of 3.27×10^{-4} .

Often it is cumbersome to deal with exponential forms, so $\text{p}K_a$ may be used to describe the tendency of a weak acid to ionize. The following equation should be used to calculate the $\text{p}K_a$ of a substance.

$$\text{p}K_a = -\log [[\text{A}^-][\text{H}_3\text{O}^+]/[\text{HA}]]$$

Relationship to $\text{p}K_a$ and acid strength: For almost all the drugs, the dissociation constants are reported as $\text{p}K_a$, regardless of whether the drug is a weak acid or a weak base. For acids, K_a refers to the ability of the acid to give out the proton. Therefore, the higher the tendency of an acid to give out the proton, the stronger is the acid (or the lower the $\text{p}K_a$ value). For bases, K_a refers to the ability of the conjugated acid form of the base to give out the proton. Therefore, the higher the conjugated acid's (of the base) tendency to give out the proton (the lower the $\text{p}K_a$ value), the weaker the original base. In other words, the conjugated acid of a stronger base has a lesser tendency to give out the proton because a strong base attracts the proton more than a weak base does.

Some examples of acidic and basic drugs;

Acidic Drugs :	$\text{HA} + \text{H}_2\text{O} \rightleftharpoons \text{H}_3\text{O}^+ + \text{A}^-$			
	K_a	K_b	$\text{p}K_a$	$\text{p}K_b$
Penicillin V	2.0×10^{-3}	5.4×10^{-12}	2.7	11.3
Acetylsalicylic Acid	3.3×10^{-4}	3.1×10^{-11}	3.5	10.5
Ascorbic Acid	5.0×10^{-5}	2.0×10^{-10}	4.3	9.7
Zidovudine	2.0×10^{-10}	5.0×10^{-5}	9.7	4.3
Basic Drugs :	$\text{A} + \text{H}_2\text{O} \rightleftharpoons \text{HA}^+ + ^-\text{OH}$			
	K_a	K_b	$\text{p}K_a$	$\text{p}K_b$
Caffeine	2.5×10^{-4}	4.0×10^{-11}	3.6	10.4
Zalcitabine	6.3×10^{-5}	1.6×10^{-10}	4.2	9.8
Theophylline	3.4×10^{-6}	1.6×10^{-9}	5.2	8.8

Morphine	7.4×10^{-7}	7.4×10^{-7}	7.9	6.1
Erythromycin	2.0×10^{-9}	6.3×10^{-6}	8.8	5.2

Importance of pK_a . It is because pK_a affects the proportion of drug molecules in the ionized and unionized forms. The ratio of ionized over unionized form affects drug's solubility, permeability, binding, and other characteristics. The pK_a allows to determine the charge on a molecule at any given pH. pK_a and Log P measurements are useful parameters in understanding the behavior of drug molecules.

HYDROGEN BONDING

The hydrogen bond is a special type of dipole-dipole interaction between the hydrogen atom in a polar bond such as N—H, O—H, or F—H and an electronegative atom O, N, or F atom. This interaction is written as A—HB.

A and B represent O, N or F. A—H is one molecule (or) part of a molecule and B is a part of another molecule; and the dotted line represents the hydrogen bond. These three atoms usually lie along a straight line, but the angle AHB can deviate as much as 30° from linearity. Ex: Hydrogen bonding in NH_3 , H_2O and HF

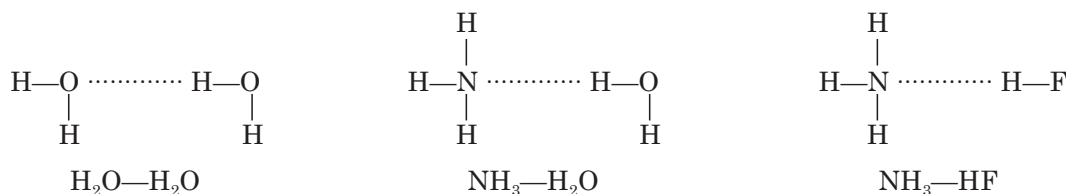

Generally the hydrogen bonding is classified into 2 types

- (A) Intermolecular hydrogen bonding
- (B) Intramolecular hydrogen bonding

(A) Intermolecular hydrogen bonding. In this type, hydrogen bonding occurs between two or more than two molecules of the same compound and results in the formation of polymeric aggregate.

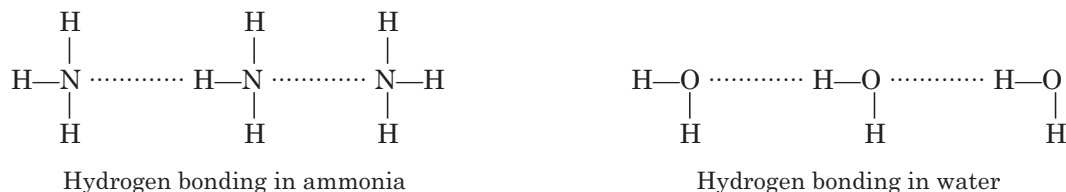

Intermolecular hydrogen bonding increases the boiling point of the compound and also its solubility in water. The molecules that are able to develop intermolecular hydrogen bonding improve their solubility by the formation of intermolecular hydrogen bonding with water. Ex: Ethanol shows higher boiling point and higher solubility in water than dimethyl ether even though both have the same molecular weight.

	<i>Molecular Weight</i>	<i>Boiling Point</i>
Ethanol (C ₂ H ₆ O)	46	78°C
Dimethyl ether (C ₂ H ₆ O)	46	- 25°C
Diethyl ether (C ₄ H ₁₀ O)	74	61°C
1-Butanol (C ₄ H ₁₀ O)	74	118°C

(B) Intramolecular hydrogen bonding. In this type, hydrogen bonding occurs with in two atoms of the same molecule. This type of hydrogen bonding is commonly known as chelation and frequently occurs in organic compounds. Sometimes intramolecular hydrogen bonding develops a six or 5-membered ring. Ex:

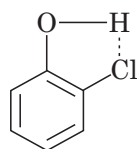

Hydrogen bonding in
o-chlorophenol

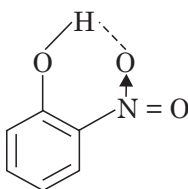

Hydrogen bonding in
o-nitro phenol

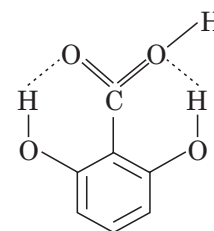

Hydrogen bonding in
2, 6 dihydroxy benzoic acid

Intramolecular hydrogen bonding decreases the boiling point of the compound and also its solubility in water. This is because of the fact that the chelation between the ortho substituted groups restricts the possibility of intermolecular hydrogen bonding with water and thus prevents association of the molecules, which would have raised the melting point, boiling point.

<i>Compound</i>	<i>Boiling Point</i>
<p><i>o</i>-Nitrophenol</p> <p>Intra molecular hydrogen bonding in <i>o</i>-nitro phenol</p>	215°C
<p><i>p</i>-Nitrophenol</p> <p>Intermolecular hydrogen bonding</p>	279°C

m-Nitrophenol

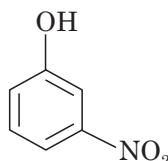

279°C

Effects of hydrogen bonding. Almost all physical properties are affected by hydrogen bonding. Here only those properties that are prominently altered such as boiling points, melting point, water solubility etc., are discussed. In addition to physical properties several chemical properties like acid character, basic character, properties of carbonyl group are also affected by hydrogen bonding.

(i) **Boiling and melting points.** Intermolecular hydrogen bonding increases the boiling point of the compound due to association of several molecules of the same compound. As a result the intermolecular forces are increased and hence more energy (large amount of heat) is required to dissociate the molecules for vaporization. Intramolecular hydrogen bonding decreases the boiling point of the compound because of the fact that the chelation between the groups of same molecule restricts the possibility of intermolecular hydrogen bonding and thus prevents association of the molecules, which would have raised the melting point and boiling point.

(ii) **Water solubility.** Solubility of a substance increases tremendously when hydrogen bonding is possible between the solvent and the solute. Ex: Methanol and ethanol are highly soluble in water due to hydrogen bonding between molecules.

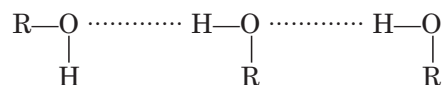

The high solubility of polyhydric phenols and sugars may be attributed to the fact that these compounds make available greater number of —OH groups for hydrogen bonding.

(iii) **Strength of acids.** Any structural feature that contributes for the greater stability of anion in comparison to free acid will shift the ionization equilibrium to the right. Thus if the anion of acid were stabilized due to intramolecular hydrogen bonding, there would be marked increase in the strength of acid. Ex: The ionization constant of salicylic acid is higher than the other two isomers and is 17 times more acidic than benzoic acid.

(iv) **Spectroscopic properties.** The hydrogen bonding shifts the position of bands in infrared and NMR spectra of organic compounds. Ex: Infrared spectrum of ethyl alcohol in vapour phase shows absorption band at 3700 cm⁻¹ due to free hydroxyl group. In solution this band is completely replaced by a broad band around 3500 cm⁻¹ which is characteristic of hydrogen bonded hydroxyl groups.

(v) **Surface tension and Viscosity.** The compounds which possess hydrogen bonding are found to have higher surface tension and viscosity. Glycerol, glycol, sulphuric acid, sugar syrup, phosphoric acid, etc., are viscous liquids due to extensive hydrogen bonding between their molecule. Due to more number of hydroxyl (—OH) groups, the extent of hydrogen bonding is more in glycerol. So, it is more viscous than glycol.

(vi) **Biological products.** The three dimensional structures of proteins and nucleic acids is due to hydrogen bonding. In α -helices, hydrogen bonds extend from the hydrogen atoms of polar N—H units in peptide group to oxygen atoms of polar carbonyl units.

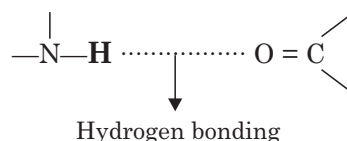

Hydrogen bonds are extremely important in the chemistry of the genetic code. The double strands of DNA are held together by hydrogen bonds. The replication of DNA depends on hydrogen bonds which selectively connect specific base pairs, as do the several steps by which the genetic message determines the specific order of amino acids in a protein.

(vii) **Drug-Receptor interactions.** Hydrogen bonding is also a secondary binding force in drug-receptor interactions.

MOLAR REFRACTIVITY (MR)

The molar refractivity is the molar volume connected by the refractive index. It represents size and polarizability of a fragment or molecule. Originally proposed by Pauling and Pressman as a parameter for the correlation of dispersion forces involved the binding of haptens to antibodies. It is determined from the refractive index, n , the molecular weight, and the density of a crystal, d .

$$\text{MR} = \frac{(n^2 - 1)}{(n^2 + 1)} \cdot \frac{\text{MW}}{d}$$

Since refractive index doesn't change much for organic molecules, the term is dominated by the MW and density. Larger MW, larger the steric effect and greater the density. A smaller MR for the same MW indicates stronger interactions in the crystal (larger density indicates that the packing is better due to stronger interactions).

IONIZATION OF DRUGS

The accumulation of an ionized drug in a compartment of the body is known as "ion trapping". The ionization of a drug is dependent on its pK_a and the pH. The pK_a is the negative Logarithm of K_a . The K_a is the acidity constant of a compound, its tendency to release a proton. The ratio of ionized/ non ionized drug may be determined by the Henderson- Hasselbalch relationship,

$$\begin{aligned} \text{pH} - \text{pK}_a &= \log \left(\frac{[\text{A}^-]}{[\text{HA}]} \right) \\ &= \log \left(\frac{[\text{ionized}]}{[\text{non ionized}]} \right) \quad \text{for acids} \end{aligned}$$

$$\begin{aligned} \text{pH} - \text{pK}_a &= \log \left(\frac{[\text{B}]}{[\text{HB}^+]} \right) \\ &= \log \left(\frac{[\text{non ionized}]}{[\text{ionized}]} \right) \quad \text{for bases} \end{aligned}$$

$$\begin{aligned} \text{Fraction non-ionized} &= \frac{[\text{HA}]}{([\text{HA}] + [\text{A}^-])} \\ &= \frac{1}{1 + ([\text{A}^-]/[\text{HA}])} = \frac{1}{1 + \text{antilog}(\text{pH} - \text{pK}_a)} \end{aligned}$$

This may be used to derive an Effective partition coefficient :

Ex: Phenobarbital pK_a is 7.4. It is evident that phenobarbital would be predominantly in the unionised form in acidic environment.

Importance of ionisation of drugs

1. The lower the pH relative to the pK_a greater is the fraction of protonated drug (protonated drug may be charged or uncharged)
2. *weak acid at acidic pH* : more lipid-soluble, because it is uncharged—the uncharged form more readily passes through biological membranes.

Note that a weak acid at acidic pH will pick up a proton and become uncharged

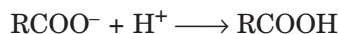

3. *weak base at alkaline pH* : more lipid-soluble, because it is uncharged—the uncharged form more readily passes through biological membranes.

Note that a weak base at more alkaline pH will lose a proton, becoming uncharged

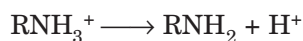

DRUG SHAPE

The shape of the drug is an important factor in defining the nature of the drug-receptor interaction. The three-dimensional shape of the drug is thought to interact with a complementary structural binding region of the receptor, typically a protein. The specific nature of the interaction defines whether the drug acts as an agonist promoting a change in cellular function or as an antagonist, which blocks the receptor usually resulting in no direct biological effect.

For example, consider acetylcholine or a synthetic analogue bethanechol (Urecholine). Interaction of these molecules with receptor (nicotinic or muscarinic cholinergic receptor) causes a physiological response i.e a decrease in heart rate for instance. Incontrast, a muscarinic antagonist such as atropine may bind even more tightly than acetylcholine to muscarinic receptor but causes no direct effect. However, following administration of antagonist a biological response may be observed as a result of receptor blockade.

COMPLEXATION

Complexes or coordination compounds result from a donor-acceptor mechanism (donating-accepting electron or, rather, an electron pair) or Lewis acid-base reaction (donating-accepting protons). Any non-metallic atom or ion, whether free or contained in a neutral molecule or in an ionic compound, that can donate an electron pair, may serve as the donor. The acceptor, or constituent that accept the pair of electrons, can be a metallic ion or sometimes also a neutral molecule. In addition to “coordinate covalence” (i.e., bonds formed by the classical electron donor-acceptor mechanism), intramolecular forces can also be involved in the formation of complexes.

Complexes may be divided broadly into two classes depending on whether the acceptor compound is a metal ion or an organic molecule.

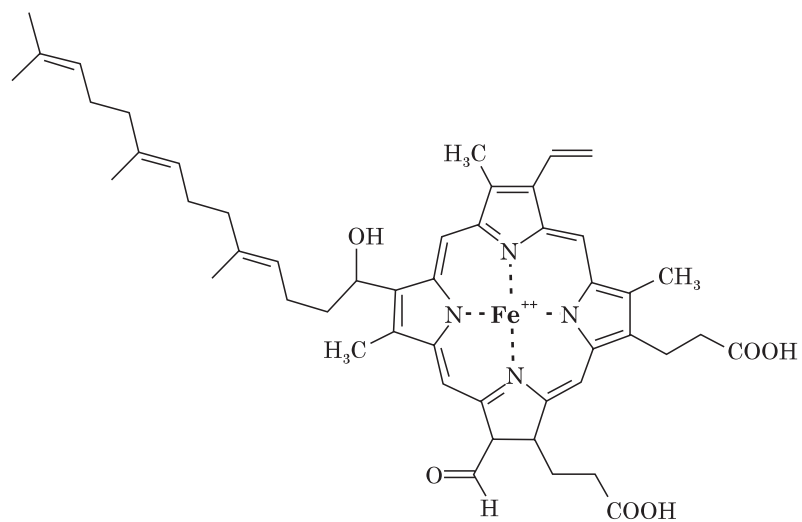

Heme *a* (found in cytochrome oxidase)

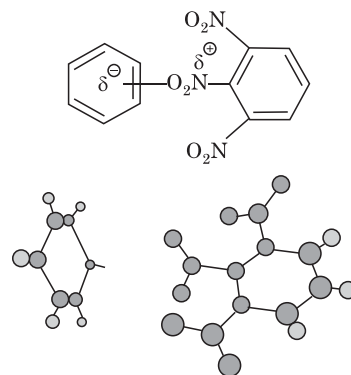

Benzene-1, 2, 3-Trinitrobenzene complex

A third class, the inclusion complexes, involve the entrapment of one compound in the molecular framework of another.

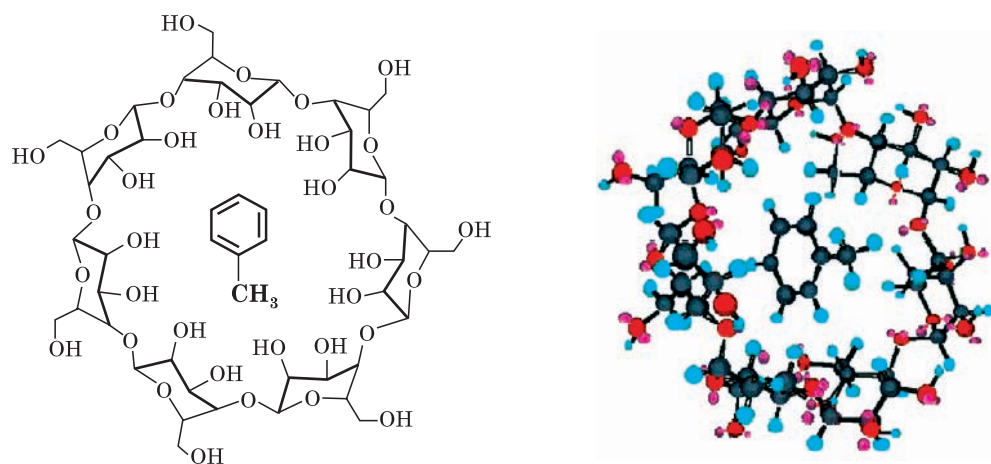

Inclusion Complex of β -Cyclodextrin (Host) and Toluene (Guest)

The compounds that are obtained by donating electrons to metal ion with the formation of a ring structure are called "chelates". The compounds capable of forming a ring structure with a metal atom are termed as ligands. Most of the metals are capable of forming chelates or complexes (if the metal is not in a ring, the compound is called a metal complex), but the chelating property is restricted to atoms like N, O and S, which are electron donating.

Applications of chelation

The phenomenon of chelation is significantly involved in biological system and to some extent in explaining drug action.

1. Dimercaprol is a chelating agent. It is an effective antidote for organic arsenical, Lewisite, but can also be used for treatment of poisoning due to antimony, gold and mercury.
2. Penicillamine is an effective antidote for the treatment of copper poisoning because it forms water-soluble chelate with copper and other metal ions.
3. 8-Hydroxyquinoline and its analogs act as antibacterial and antifungal agents by complexing with iron or copper.

SURFACE ACTIVITY

A surfactant is briefly defined as a material that can greatly reduce the surface tension of water when used in very low concentrations. This molecule is made up of water soluble (hydrophilic) and a water insoluble (hydrophobic) component.

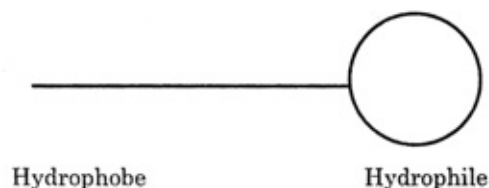

The hydrophobe is usually the equivalent of an 8 to 18 carbon hydrocarbon, and can be aliphatic, aromatic, or a mixture of both. The sources of hydrophobes are normally natural fats and oils, petroleum fractions, relatively short synthetic polymers, or relatively high molecular weight synthetic alcohols. The hydrophilic groups may be anionic, cationic or non-ionic in nature. The anionic hydrophiles are the carboxylates (soaps), sulphates, sulphonates and phosphates. The cationic hydrophiles are some form of an amine product. The non-ionic hydrophiles associate with water at the ether oxygens of a polyethylene glycol chain. In each case, the hydrophilic end of the surfactant is strongly attracted to the water molecules and the force of attraction between the hydrophobe and water is only slight. As a result, the surfactant molecules align themselves at the surface and internally so that the hydrophile end is toward the water and the hydrophobe is squeezed away from the water. The internal group of surfactant molecules is referred to as micelle.

Because of this characteristic behaviour of surfactants to orient at surfaces and to form micelles, all surfactants perform certain basic functions.

1. The bactericidal activity of cationic quaternary ammonium compounds such as benzalkonium chloride, cetrимide, cetylpyridinium chloride, etc., is explained through their surface activity property.
2. The anthelmintic activity of hexylresorcinols is explained by its surface activity property.
3. Steroidal hormones and barbiturates have surface activity properties.
4. Phenol and cresol act as disinfectants by denaturing the proteins of biological membranes.
5. Foaming agents, emulsifiers, and dispersants are surfactants, which suspend, an immiscible liquid, or a solid in water or some other liquid.

PROTEIN BINDING

Depending upon whether the drug is a weak or strong acid or base, or is neutral, it can bind to a single blood protein, to multiple proteins (e.g. serum albumin, acid-glycoprotein (AGP) or lipoproteins). The most significant protein involved in the binding of drugs is albumin, which comprises more than half of all blood proteins. Albumin can interact with acidic or basic drugs in the plasma by Vander Waals dispersion forces, hydrophobic bonding, hydrogen bonding, and ionic interactions. AGP interacts with mainly with basic entities whereas lipoproteins bind with both basic and neutral drugs. Protein binding values (% fraction bound) are normally given as the percentage of the total plasma concentration of a drug that is bound to all plasma proteins. In most cases, binding to plasma proteins is reversible, and the concentration of the free and bound species of the drug at equilibrium may be expressed as:



The total plasma concentration of the drug is expressed as the sum of the percent of free drug and the percent bound.

$$\text{Total plasma concentration [} D_t \text{] = [} D_f \text{] + [} D_p \text{]}$$

Binding measurements are made *in vitro*, at multiple drug plasma concentration levels in the clinically achievable range. A single (average) value result of such measurements indicates a relatively constant bound-to-free ratio over the range of plasma concentrations examined. In situations where drug binding is concentration dependent, two values are given, representing the percent bound values for the upper and lower limits of the range of concentrations examined. Only single activity values, indicating an average, were used in the generation of this model. The protein samples used in binding studies are taken from healthy individuals because there is several disease states that can affect the protein binding of drugs. Examples include hepatic diseases that alter the concentration of albumin in the plasma and uremia that can cause changes in the binding affinity of some drugs.

Importance

The extent to which a drug is bound to plasma proteins can affect the distribution of the drug in several ways.

The drug/protein complex does not permeate through phospholipid bilayers, including capillary membranes, glomerular membranes in the nephrons, and the blood brain barrier.

Bound drugs are also less available to the enzymes involved in first-pass metabolism. After the metabolic and excretory processes have cleared much of the free drug, the reversible drug/protein complex serves as a depot to replenish the concentration *in vivo*.

For these reasons, drugs with high protein binding activity values tend to have a greater half-life compared to those with lower values. The prolonged activity resulting from these factors may be desirable, or may promote the emergence of undesirable side effects.

The fraction of the drug which is bound to the protein is incapable of crossing cell membranes and cannot interact with receptors. It is the fraction which is free in the plasma water which has biological activity. Drugs may interact with one another at the level of plasma protein binding; some drugs may displace others from their binding sites. In this event, although the total concentration of the drug in the plasma is unaltered, its unbound concentration rises; the potency of the drug may rise as a consequence. This may have important toxic and therapeutic consequences in some cases.

BIOISOSTERISM

The term isosterism was introduced by I. Langmuir in 1919 who postulated that two molecules or ions or radicals having the same number and arrangement of electrons. Accordingly the isosters should be isoelectric i.e. they should possess same total charge.

Ex:

- (i) CO and NO₂
- (ii) CO₂ and N₂O
- (iii) N₃ and NCO⁻
- (iv) CH₂N₂ and CH₂ = CO

The widespread application of the concept of isosterism to modify biological activity has given rise to the term bioisosterism. Bioisosteres are components or groups that possess nearly equal molecular shapes and volumes, approximately the same distribution of electrons, and which exhibit similar physical properties. Bioisosteres, however, are substituents or groups that do not necessarily have the same size or volume, but have a similarity in chemical or physical properties, produce broadly similar biological properties. Traditionally bioisosters have been classified into two groups. They are;

1. Classical bioisosteres. Classical replacement is like for like in terms of number of atoms, valency, degree of unsaturation, and aromaticity and only becomes a bioisosteric replacement if biological activity is retained. The classical bioisosters may be univalent atoms and groups ((a) —CH₃, —NH₂, —OH, —F, —Cl (b) —Cl, —NH₂, —SH (c) —Br, —I, —propyl and (d) —t— Ba)—tert—butyl, bivalent atoms and groups ((a) —CH₂—, —NH—, —O—, —S—, —Se—; (b) —COCH₂—, —CONH—, —COO—, —COS—), trivalent atoms and groups ((a) —CH =, —N = and (b) —P =, —As =), tetravalent atoms and groups ((a) >C<, >Si< and (b) = C =, = N⁺ =, = P⁺ =) or ring equivalents ((a) benzene, thiophene, (b) benzene, pyridine, (c) tetrahydrofuran, tetrahydrothiophene, cyclopentane, pyrrolidine).

(i) **Flurine vs Hydrogen replacement.** The substitution of hydrogen by fluorine is one of the more commonly employed monovalent isosteric replacement. The antineoplastic agent 5-fluorouracil represents a classical example of how fluorine substitution of a normal enzyme substrate can result in a derivative, which can alter selective enzyme processes.

(ii) **Divalent replacements involving double bonds.** The replacement of C = S with C = O in Tolrestat (1), an aldose reductase inhibitor currently under study in human subjects for the treatment of diabetic neuropathy, resulted in oxo-Tolrestat (2) which retained activity both *in-vitro* and *in vivo*.

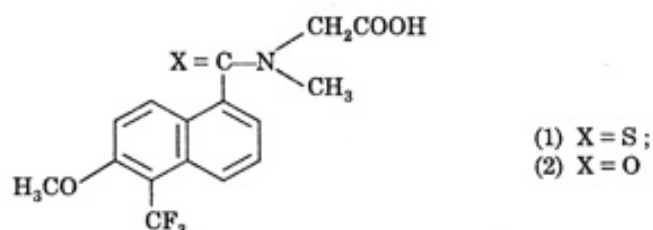

(iii) **Trivalent ring equivalents.** The trivalent substitution of —CH = with —N = is commonly used in modern drug design. Trivalent ring substitution of —CH = with —N = is the antibacterial agent norfloxacin resulted in enoxacin which is also in clinical use for its antibacterial activity.

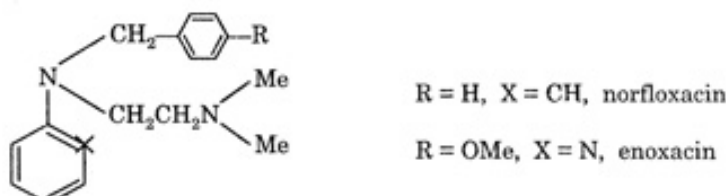

Non-classical bioisosteres. The non-classical bioisosteres comprise groups which are structurally similar but do not meet the electronic and steric requirements in the rigorous sense. These isosteres retain activity by the retention of their properties such as pK_a , electrostatic potentials, HOMO and LUMO in a derivative, which can alter selective enzyme processes etc. For which modern computational analysis methodology can aid in rationalization.

Ex: Attempts to increase the duration of action β -adrenergic antagonists by preventing the metabolism has resulted potent and selective agents.

They are albuterol (3- CH_2OH), soterenol (3- $\text{NH}\text{SO}_2\text{CH}_3$) and carbuterol (3- NHCONH_2).

Isoproterenol (3-OH) is the prototype of the β -adrenergic agonist and is widely used as bronchodilator; however it is not a β_2 -selective agent.

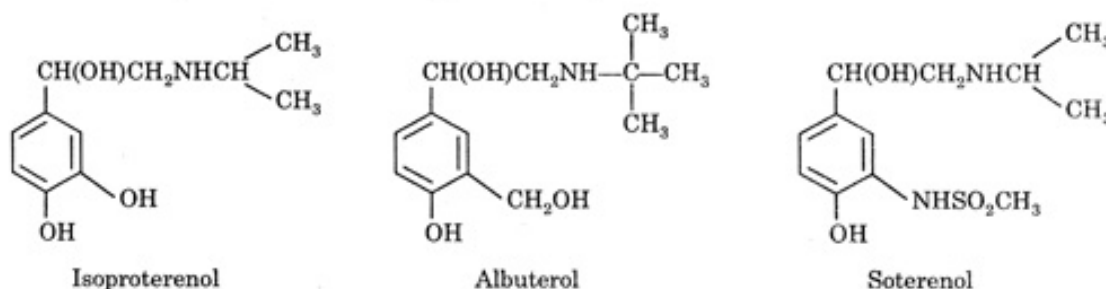

In addition this catechol is rapidly metabolized by catechol *o*-methyltransferase (COMT) which catalyzes the methylation of the *m*-hydroxy group.

2. Peptide bonds and peptide fragments have been replaced with a wide variety of structural moieties in attempts to convert peptides into chemically stable and orally available molecules. Bioisosteres of the amide bond are:

$-\text{CONH}-$, $\text{NHCN}-$, $\text{CH}_2\text{NHCO}-$, $-\text{COCH}_2-$, $-\text{NHCONH}-$, $-\text{CH}_2\text{NH}-$, NHCO_2- , $\text{NHCOS}-$, CO_2- , NHSO_2- , $-\text{CH}(\text{OH})\text{CH}_2$, etc.

3. In search for improved antihyperlipidemic agents the tetrazolyl analogue of nicotinic acid was found to be three times as active in lowering blood cholesterol

Bioisosterism represents one approach used by the medicinal chemists for the rational modification of lead compounds into safer and more clinically effective agents. Thus bioisosterism has numerous advantageous applications in resolving biological problems effectively.

4

Chemistry of Prodrugs

THE PRODRUG CONCEPT

The prodrug concept was first proposed by Albert in 1958. Albert and his co-workers described prodrugs as pharmacologically inactive chemical derivatives that could be used to alter the physicochemical properties of drugs, in a temporary manner, to increase their usefulness and/or to decrease associated toxicity.

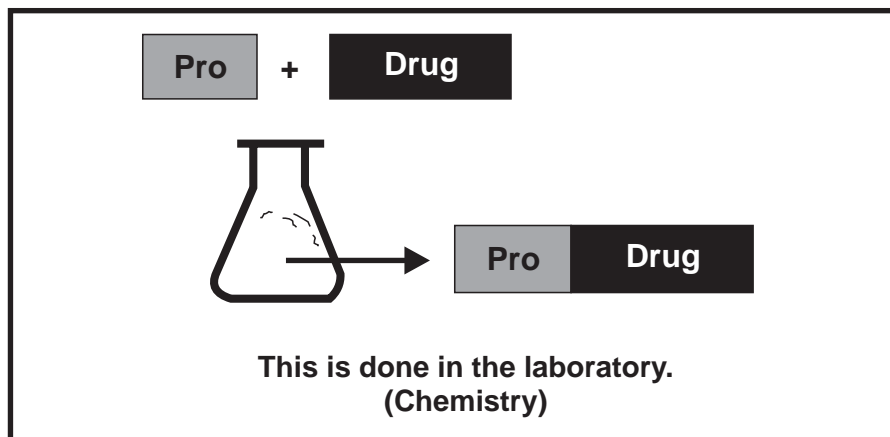
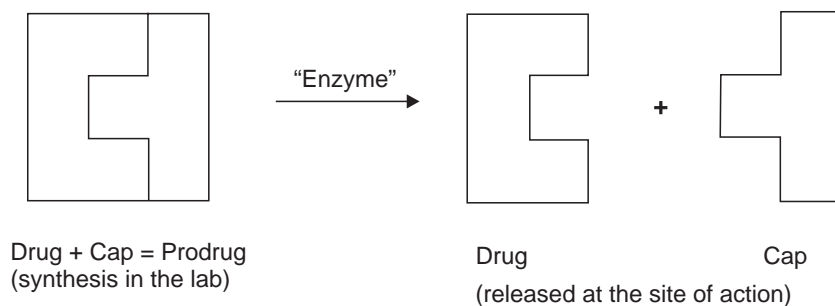

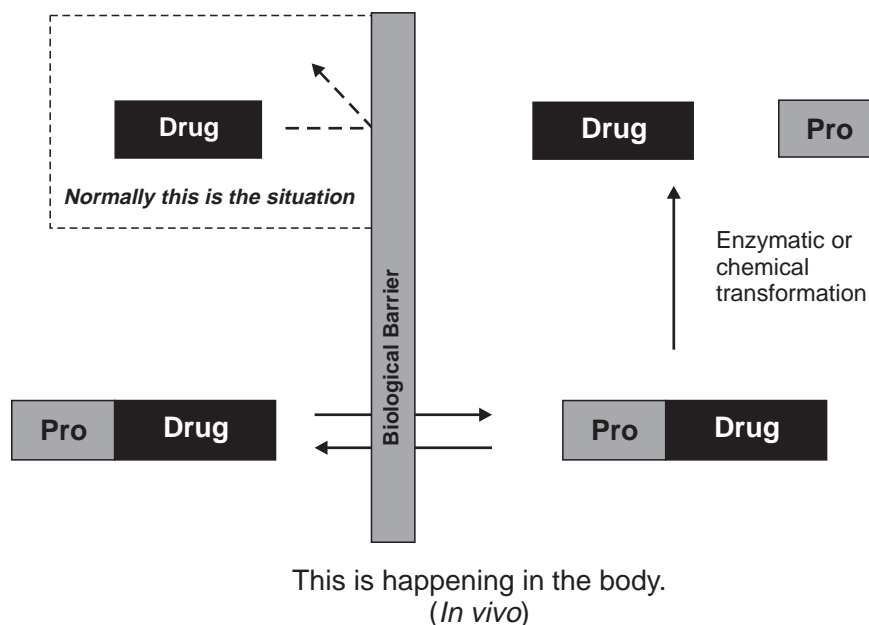

They have also been called 'latentiated drugs', 'bioreversible derivatives', and 'congeners'. Ideally, the prodrug is converted to the original drug as soon as the derivative reaches the site of action, followed by rapid elimination of the released derivatizing group without causing side effects in the process.

Ex:

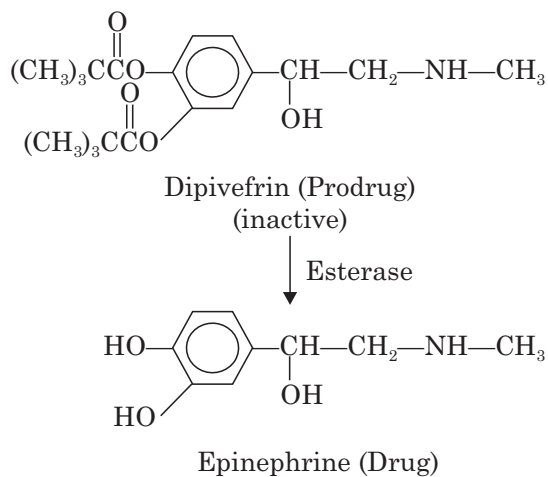

Prodrugs are pharmacologically inactive derivatives of active drugs. They are designed to maximize the amount of active drug that reaches its site of action, through manipulation of the physicochemical, biopharmaceutical or pharmacokinetic properties of the drug.

APPLICATIONS OF PRODRUGS

Prodrugs are converted into the active drug within the body through enzymatic or non-enzymatic reactions. The various applications of prodrug approach are;

1. Improved physicochemical properties (e.g., better solubility in the intended formulation)
2. Enhanced delivery characteristics and/or therapeutic value of the drug
3. To improve drug penetration through biological membranes
4. To increase site specificity of the drug
5. To improve the drug's stability and solubility
6. To increase duration of pharmacological activity
7. To decrease the drug's toxicity and adverse effects
8. To improve patient acceptance.

IDEAL REQUIREMENTS OF PRODRUGS

An ideal prodrug must meet the following requirements;

1. The prodrug is inactive or less active than the parent compound
2. The linkage between the drug and the carrier must be cleaved *in vivo*
3. The carrier molecule released *in vivo* must be non-toxic
4. The metabolic fragments of carrier molecule, apart from the drug should be non-toxic

CLASSIFICATION OF PRODRUGS

The prodrugs are classified according to the functional group. They are;

1. Carboxylic acids and alcohols. Prodrugs of carboxylic acid and alcohol functionalities can be prepared by conversion to an ester. The ester can be easily hydrolysed by esterase enzymes (ester hydrolase, lipase, cholesterol esterase, acetylcholinesterase, carboxypeptidase) present in plasma and other tissues to give active drug.

Ex:

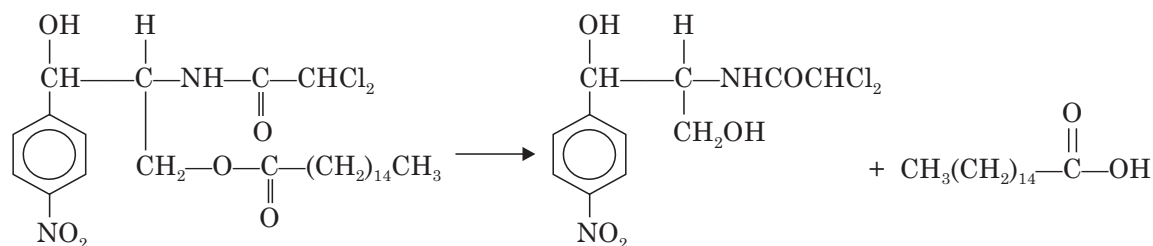

Chloramphenicol palmitate

Chloramphenicol

Palmitic acid

Antibiotic prodrugs comprise the largest group of prodrugs developed to improve oral absorption.

Ex: Pivampicillin, talampicillin and bacampicillin are prodrugs of ampicillin, all resulting from the esterification of the polar carboxylate group. The absorption of these prodrugs is nearly complete (98-99%) whereas that of ampicillin is < 50%.

Enalapril, the most widely prescribed ACE inhibitor, is the ethyl ester prodrug of the active diacid, enalaprilat. Enalaprilat is poorly absorbed from the gastrointestinal tract (< 10%), but absorption of the prodrug enalapril is greatly improved (60%).

2. Amines. Due to high chemical stability of amide linkage and lack of amidase enzymes amines are not derivatised to amide prodrugs. A more common approach has been to utilize mannich bases as a prodrug form of the amines.

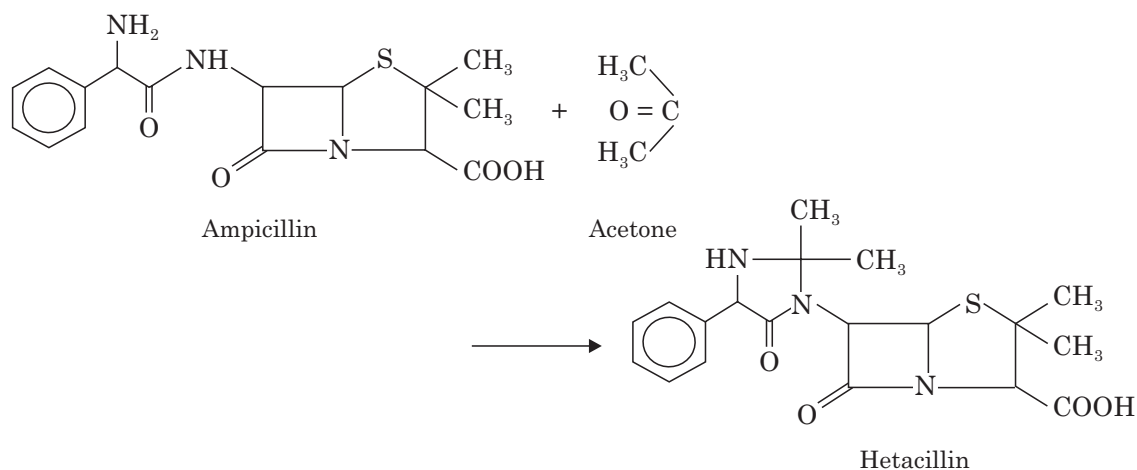

3. Azo Linkage. Amines are derivatised to azolinkage prodrugs.

Ex: Prontosil

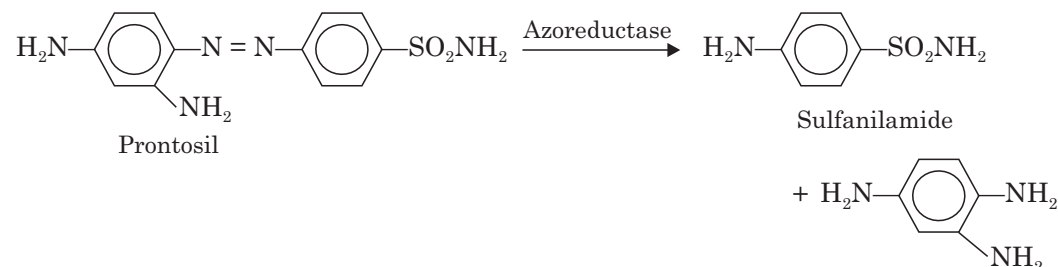

4. Carbonyl compounds. Carbonyl functionalities such as aldehydes and ketones are converted to prodrugs. However this approach has not found wide clinical utility. These have generally involved derivatives in which the sp^2 hybridized carbonyl carbon is converted to an sp^3 hybridised carbon attached to two heteroatoms such as oxygen, nitrogen, or sulfur. These prodrugs are reconverted to the carbonyl compounds by hydrolysis.

Ex: Methenamine releases HCHO in the urine, which acts as an antibacterial agent.

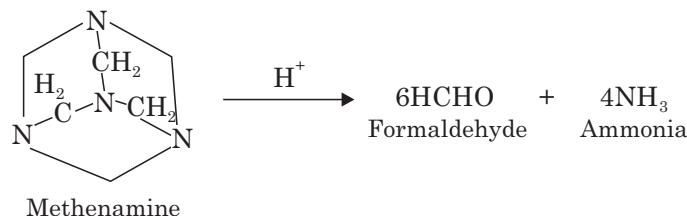

DEVELOPMENT OF PRODRUGS:

The successes of prodrug design are many, and a large variety of such compounds have proven their therapeutic value. Some important prodrug concepts are described below;

1. To Improve patient acceptance. One of the reasons for poor patient compliance, particularly in case of children, is the bitterness, acidity or causticity of the drug. Two approaches can be utilized to overcome the bad taste of drug. The first is reduction of drug solubility in saliva and the other is to lowers the affinity of drug towards taste receptors.

Ex. : Clindamycin has bitter taste, so it is not well accepted by children. It was found that by increasing the chain-length of 2-acylestere of clindamycin, the taste improved from bitter to non-bitter taste (phosphate ester).

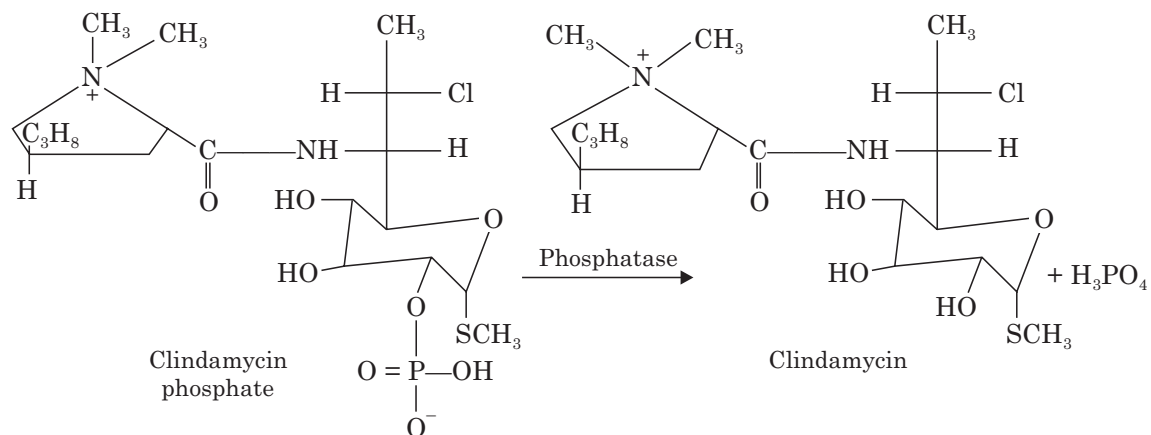

2. To reduce gastric irritation. Several drugs (NSAIDS, nicotinic acid, kanamycin, diethylstilboestrol) cause irritation and damage to gastric mucosa. These problems of drugs can be overcome by changing to prodrugs.

Ex. : Salicylic acid to aspirin

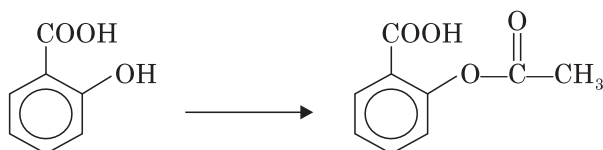

Nicotinic acid to nicotinic acid hydrazide

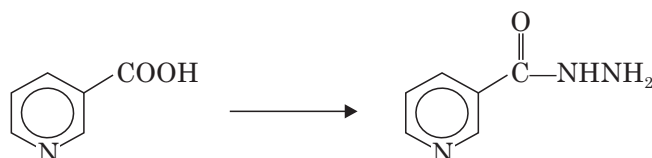

3. To improve chemical stability. Several drugs may decompose during their shelf life or in the GIT when used orally. The prodrug approach of such drugs is a good technique to improve stability.

Ex. : Azacytidine (antineoplastic drug) in aqueous solution is readily hydrolyzed but its bisulphite prodrug is stable.

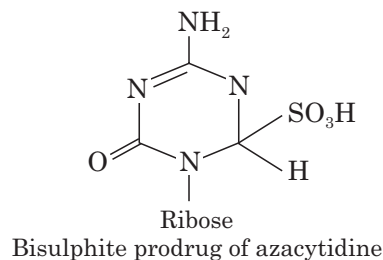
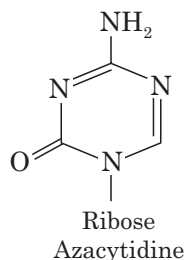

4. Prodrugs for increased water solubility. Drugs with hydroxyl functional group can be converted into their hydrophilic forms by use of half-esters such as hemiglutarates or hemiphthalates ; the other half of these acidic carriers can form sodium, potassium or amine salts and render the moiety water soluble.

Ex. : Prednisolone and methylprednisolone are poorly water-soluble corticosteroid drugs. Prednisolone phosphate is a water-soluble prodrug of prednisolone that is activated *in vivo* by phosphatases.

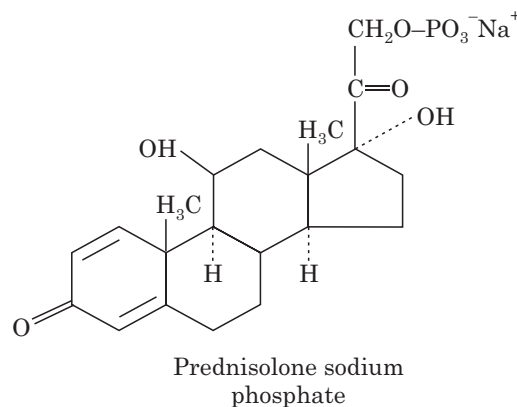
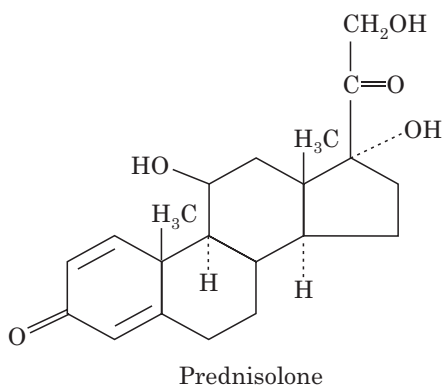

5. To decrease drug's toxicity and adverse effects. An important objective of drug design is to develop drugs with high activity and low toxicity.

Ex. : Dipivaloylepinephrine prodrug instead of epinephrine to treat glaucoma.

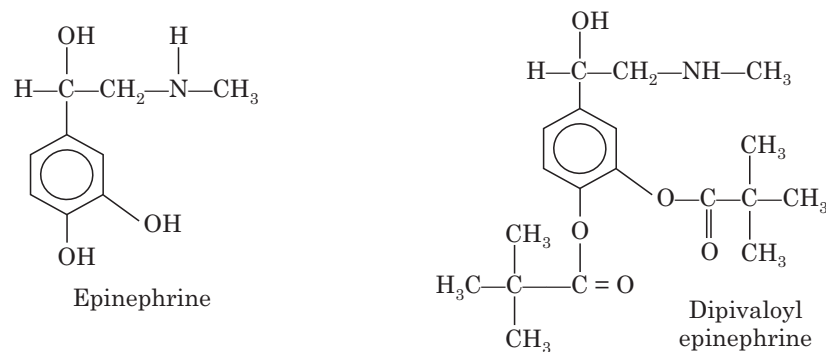

Esterification of aspirin greatly suppresses gastric uterogenic activity.

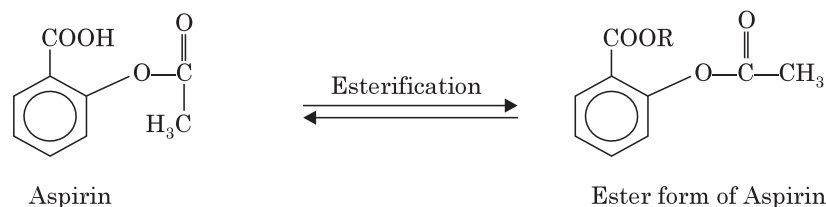

6. To improve membrane transport. Barbiturates are a group of compounds responsible for profound sedative and hypnotic effect. They are weakly acidic in nature and are converted to the corresponding sodium salt in aqueous sodium hydroxide. The sodium salt is extensively employed for intravenous anesthetic properties. Barbituric acid is the parent member of this group of compounds. Various barbiturates differ in the time required for the onset of sleep and in the duration of their effect. Hexobarbitone was found to be an effective drug but its membrane permeability was found to be low. However N-methylhexobarbitone a simple derivative of the parent drug was found to have better permeability characteristics. After intake, the N-methyl group is cleaved in the liver to release the physiologically active drug.

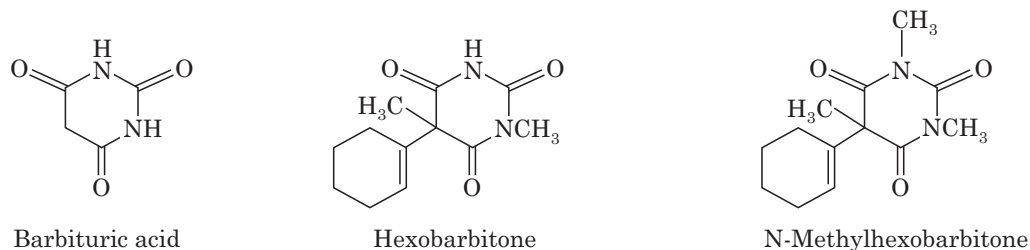

Similarly, membrane transportation characteristics of the neurotransmitter dopamine used for the treatment of Parkinson's disease can be improved by administering its prodrug L-3,4-dihydroxyphenylalanine (Levo-DOPA). This derivative has better blood-brain permeation characteristics since it uses amino acid channels for transportation. Once inside the cell, decarboxylase enzyme removes the acid group to generate dopamine.

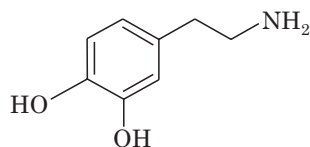

Dopamine

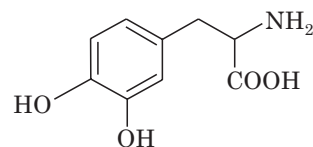

Levo-DOPA

7. Prolonged Activity. The prodrug by its improved characteristics gets closer to the receptor site for a longer period of time, and conversion to the parent drug takes place at the site of action.

Nordazepam is a drug used for sedation, particularly as an anxiolytic. It is also used as a muscle relaxant. However, it loses activity too quickly due to metabolism and excretion. A prodrug introduced to improve the retention characteristics is (diazepam). Due to presence of N-methyl group the prodrug resists quick degradation. Slow release of the nordazepam in the liver by demethylation prolongs body retention characteristics.

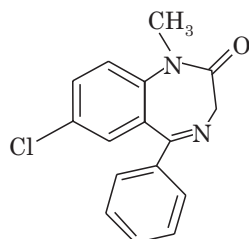

Diazepam (Valium)

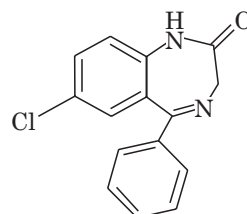

Nordazepam

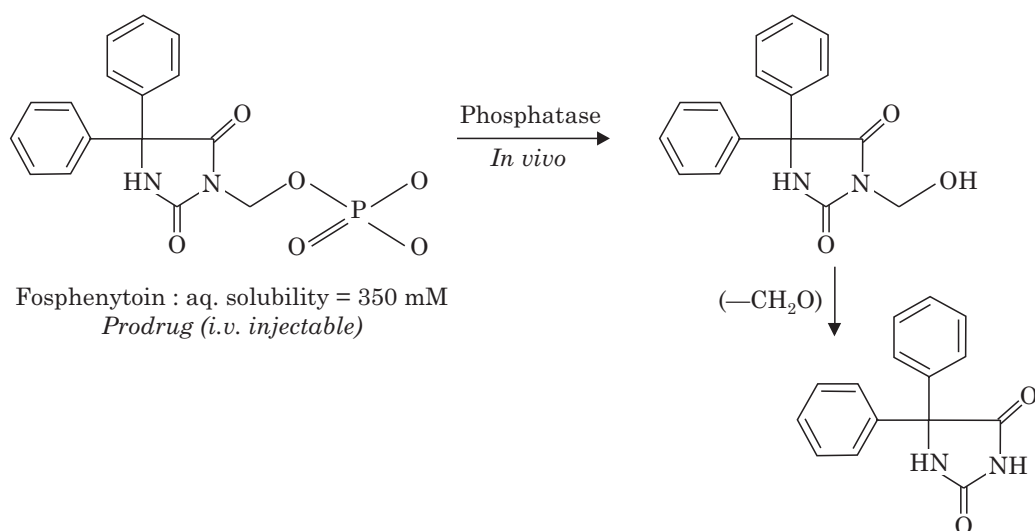

Fosphenytoin : aq. solubility = 350 mM
Prodrug (*i.v. injectable*)

Phenytoin : aq. solubility = 0.08 mM
Drug (*anticonvulsant*)

8. Tissue specific prodrug design. The site-specific drug delivery can be achieved by the tissue activation, which is the result of an enzyme unique to the tissue or present in higher concentration. Dexamethasone and prednisolone are corticosteroids used for anti inflammatory

properties. They are steroid drugs and are hydrophobic in nature. They are absorbed efficiently in intestinal tract and as such do not reach colon area for treatment. However, when prodrugs dexamethasone-21- β -glucoside and prednisolone-21- β -glucoside were used they were absorbed in colon more efficiently compared to their parent drugs. The prodrugs are hydrophilic in nature and therefore are absorbed poorly in intestine. The glucosidase enzymes present in the bacteria located in colon release the parent hydrophobic drugs for absorption in the area.

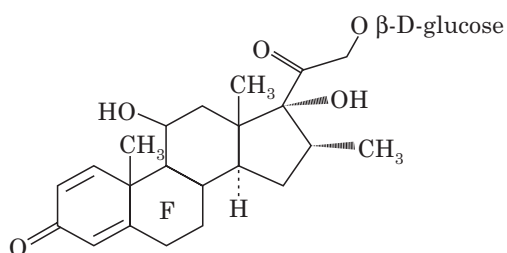

Prodrug of dexamethasone

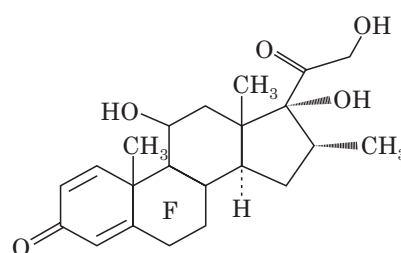

Dexamethasone

9. Prodrug design based on site specific conditions. Tumor cells associated with cancer can be differentiated from normal cells. The blood vessels in the tumor tissue often lack regularity and systematic connectivity leaving unvascularized zones, especially in the interior areas leading to unstable blood flow. Cells that do not have blood supply die as a result of lack of oxygen supply and also the intermediate regions get deficient supply of oxygen. This area is called hypoxia region.

For example, tyrapazamine has been developed as a cytotoxic agent. It has two N-oxide moieties, which on reduction gets converted to highly reactive diradicals. The diradicals are responsible for cleavage of DNA.

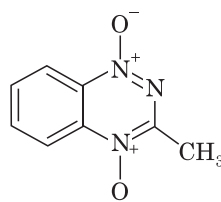

Tyrapazamine

10. Enzyme specific prodrug design. Cancer cells due to differing physiological conditions, enzyme groups such as glucuronidases, proteases receptors show activity in excess in cancer cells compared to normal cells. Several prodrugs have been developed taking advantage the excessive activity of the above enzymes in tumor tissues.

Derivatives of doxorubicin and paclitaxel were prepared wherein active sites are blocked by strategically attaching suitable polypeptide to the drug but separated by spacer. The spacer was used to expose the polypeptide chain open for plasmin activity. Both the prodrugs were found to be inactive and stable under biological pH conditions but they were readily cleaved with the release of parent drugs in the presence of plasmin enzymes present in tumor cells. The prodrugs were synthesized by blocking important functional group in the molecule with a polypeptide-capping agent to make them inactive. The spacer group was designed to self eliminate after hydrolysis of the polypeptide chain by the enzyme.

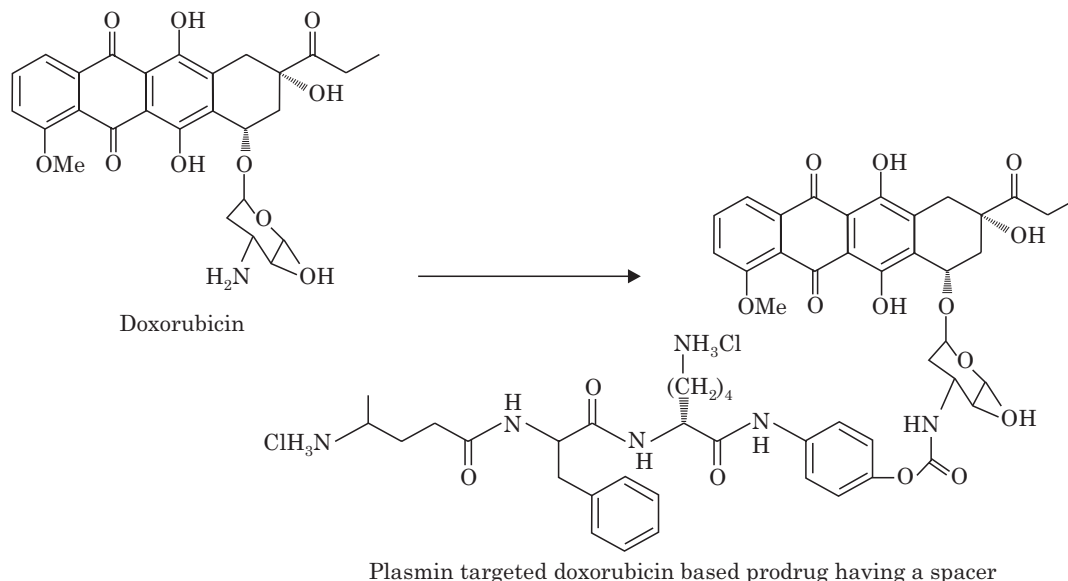

SOFT DRUGS

The soft drugs are defined as therapeutically beneficial agents characterised by a predictable and controllable *in vivo* metabolism to non-toxic moieties, after they achieve their therapeutic role. The application of soft drugs concept is necessary to overcome and to improve (a) pharmacokinetic insufficiencies (b) transportability and (c) site specificity. The designed soft drug is transformed by facile and predicted routes of metabolism ultimately resulting in the delivery of the active drug at the expected sites of action.

The soft drug concept was successfully applied to local delivery of steroids, drugs acting on specific areas in eyes, brain and testes.

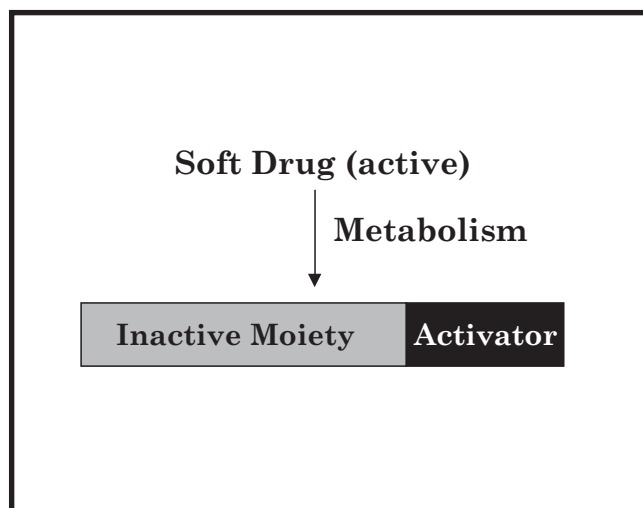

Soft drug concept

5

Drug Metabolism

INTRODUCTION

Metabolism is the body's mechanism for processing, using, inactivating, and eventually eliminating foreign substances, including drugs. Drug exerts its influence upon the body, it is gradually metabolized, or neutralized. The liver, the blood, the lymph fluid, or any body tissue that recognizes the drug as a foreign substance can break down or alter the chemical structure of drugs, making them less active, or inert. Drugs also can be neutralized by diverting them to body fat or proteins, which hold the substances to prevent them from acting on body organs. Once a drug is metabolized, it is the kidneys that normally filter the neutralized particles, called metabolites, as well as other waste and water, from the blood. Drugs can also be excreted out of the body by the lungs, in sweat, or in feces.

Drug metabolism is basically a process that introduces hydrophilic functionalities onto the drug molecule to facilitate excretion. Metabolism is defined as the process of polarization of a drug. This results in the formation of a metabolite that is more polar and, thus, less able to move into tissues and more able to be excreted from the body. Drug metabolism is a detoxification function the human body possesses to defend itself from environment hostility. Metabolism is a major mechanism of drug elimination.

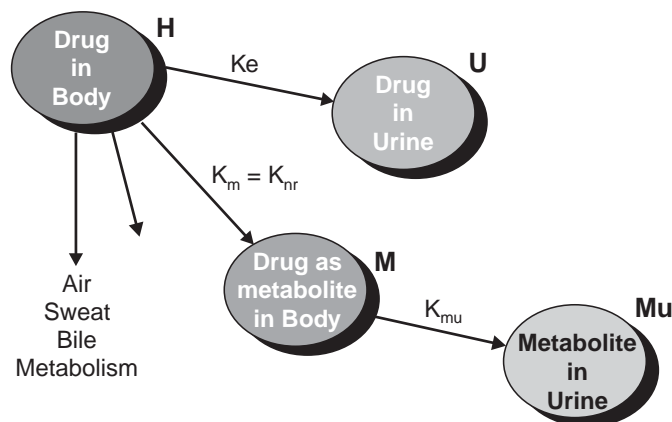

The first human metabolism study was performed in 1841 by Alexander Ure, who observed the conversion of benzoic acid to hippuric acid and proposed the use of benzoic acid for the treatment of gout.

SITES OF METABOLISM

Liver

Liver is the primary site for metabolism. Liver contains the necessary enzymes for metabolism of drugs and other xenobiotics. Metabolic processes may either decrease or increase the effects of drugs.

For example, the liver enzymes help to convert ethanol, (the active ingredient in alcohol), into water, oxygen and carbon dioxide, which are then excreted from the body through the kidneys, sweat glands, and lungs. However, metabolic processes occasionally increase the effects of psychoactive drugs. Diazepam is transformed by the liver enzymes into 3 or 4 compounds which are more active than the original drug.

Since isoniazid is active and N-acetylisoniazid is not, the rate and extent of metabolism will affect the efficacy of the drug in treating tuberculosis.

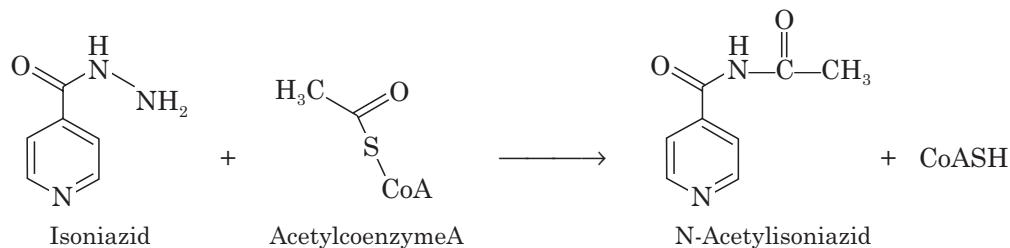

Other main organs of biotransformation

Although liver is the primary site for metabolism, virtually all tissue cells have some metabolic activities. Other organs having significant metabolic activities include the gastrointestinal tract, kidneys, and lungs. Recently, it has become apparent that metabolism may occur in the epithelial cells lining the gastrointestinal tract.

METABOLIC REACTIONS

Metabolic conversions are classified as either Phase I (oxidation, reduction or hydrolysis), or Phase II (conjugation).

PHASE I : REACTIONS

Phase I metabolism is likely to be the predominant pathway of biotransformation. The enzymes involved in Phase I reactions are primarily located in the endoplasmic reticulum of the liver cell, they are called microsomal enzymes. Phase I reactions are non-synthetic in nature, and generally produce more water soluble and less active metabolite. The most common phase I reactions are oxidative processes (aromatic hydroxylation; aliphatic hydroxylation; N—, O—, and S-dealkylation; N-hydroxylation; N-oxidation; sulfoxidation; deamination; and dehalogenation), reductive (azodye-reduction, nitroreduction) and hydrolytic reactions.

Oxidation. Oxidation is normally the first step of drug metabolism. Mixed-function oxidases or monooxygenases is an important complex enzyme catalyses metabolic oxidation of

a large variety of endogeneous substances (steroidal hormones) and exogeneous substances (drugs). Some important metabolic oxidations are represented here:

Oxidation of carbon-heteroatom systems. Carbon-heteroatom systems (N, O, S) are commonly present in many drugs. They are metabolized by any of the following oxidation processes :

(a) Oxidation or hydroxylation of heteroatom: Ex: N-oxidation, N-hydroxylation, S-oxidation.

(b) Hydroxylation of carbon atom attached to the heteroatom followed by cleavage of carbon-heteroatom bond. Ex: N-dealkylation, S-dealkylation, O-dealkylation.

N-Hydroxylation

Drugs containing non-basic nitrogen atom (amides), non-basic aromatic amines and basic amines are metabolized by N-hydroxylation. Ex:

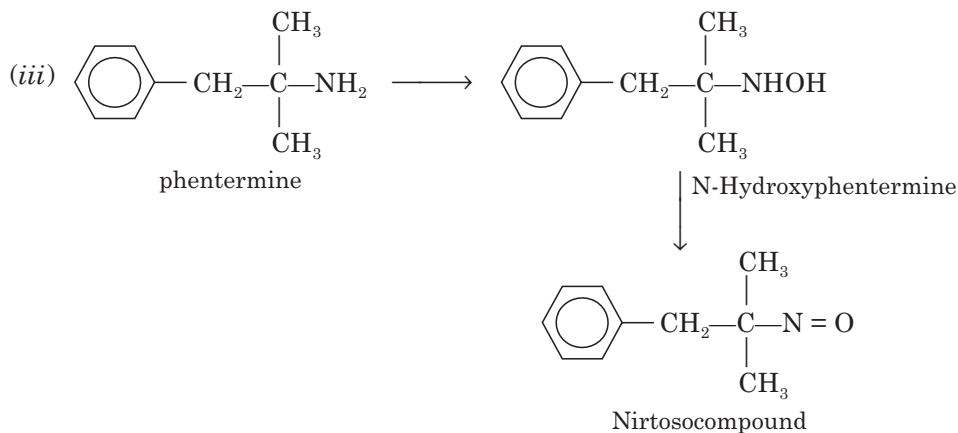
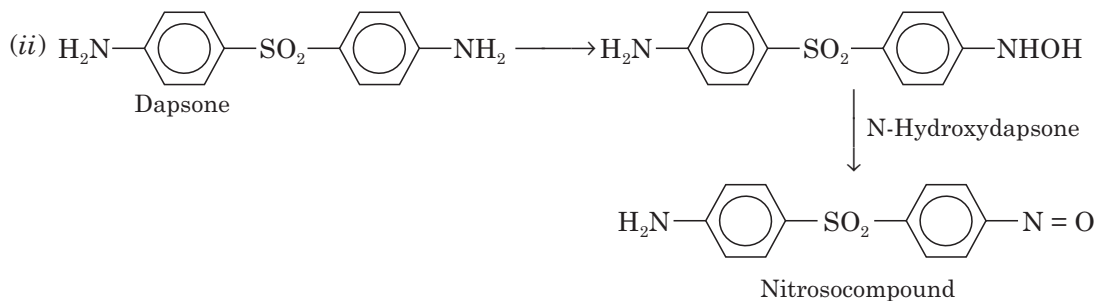
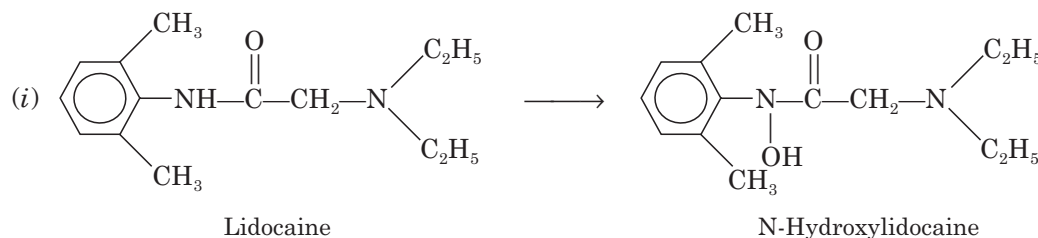

N-Oxidation

Compounds possessing of basic nitrogen are metabolized by N-oxidation process.

Ex: Tertiary amines yield N-oxides

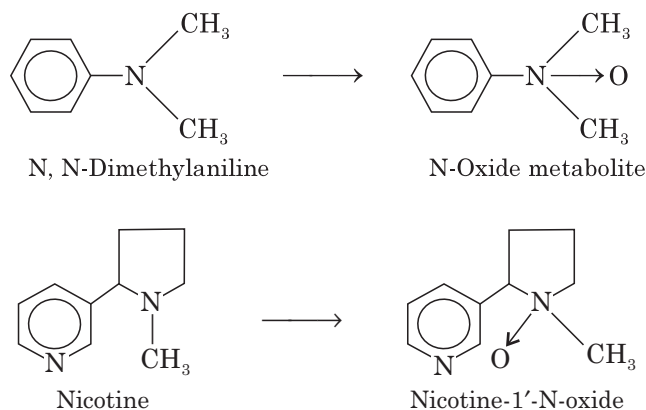
**S-Oxidation**

Compounds possessing of carbon-sulfur bonds are metabolized to sulfoxides by S-oxidation. The sulfoxides may be excreted as urinary metabolites or oxidized to sulfones ($-\text{SO}_2-$).

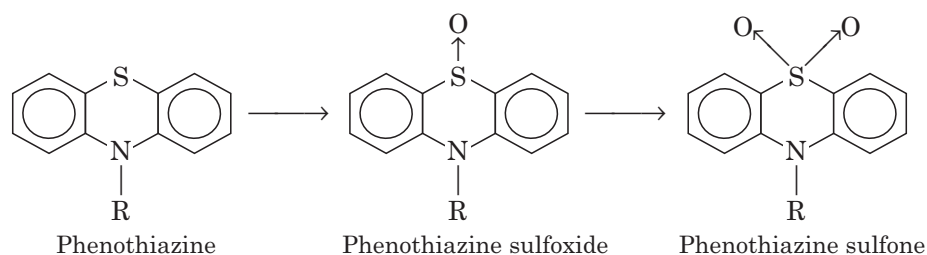

Dealkylations. The second type of oxidative biotransformation comprises dealkylations.

S-Dealkylation. S-Dealkylation involves oxidative cleavage of alkyl carbon-sulfur bonds.

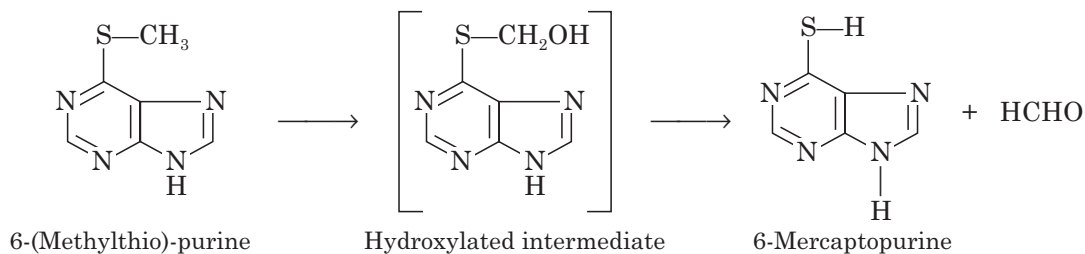

N-Dealkylation. In the case of primary or secondary amines, dealkylation of an alkyl group starts at the carbon adjacent to the nitrogen; in the case of tertiary amines, with hydroxylation of the nitrogen (ex: Lidocaine).

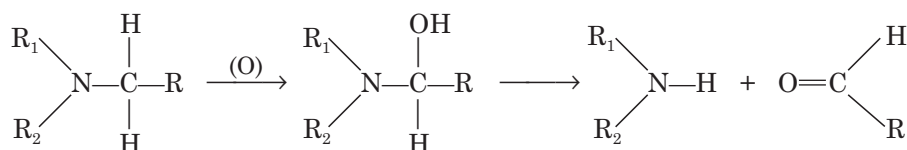
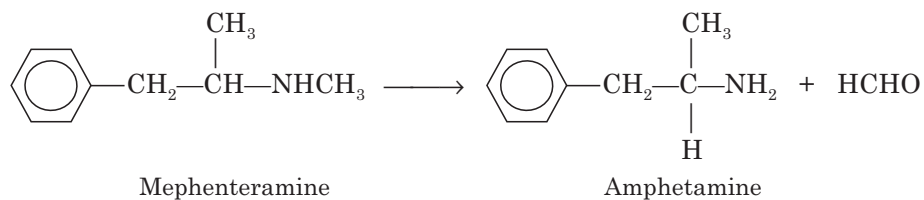

The intermediate products are labile and break up into the dealkylated amine and aldehyde.

O-Dealkylation. O-Dealkylation of drugs possessing C—O bond involves hydroxylation of α -carbon to form an unstable hemiacetal or hemiketal intermediates. These intermediates spontaneously cleave to form alcohol and carbonyl compound.

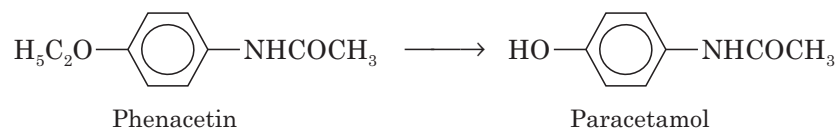

Aromatic Hydroxylation (Oxidation of Aromatic Carbon Atoms)

Aromatic hydroxylation is oxidation of aromatic compounds into phenols through the intermediate formation of highly reactive immediate i.e. arene oxide.

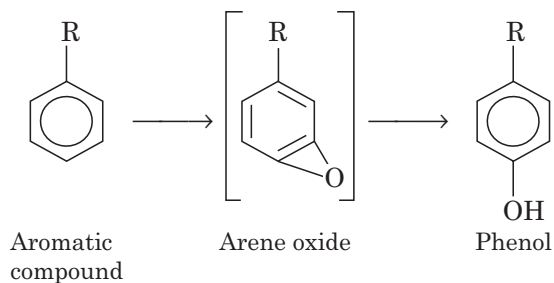

Ex: Many drugs containing phenyl groups (phenylbutazone, phenytoin, amphetamine, phenformin etc.) are metabolized by aromatic hydroxylation.

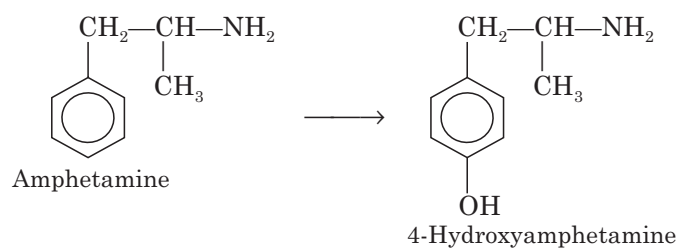

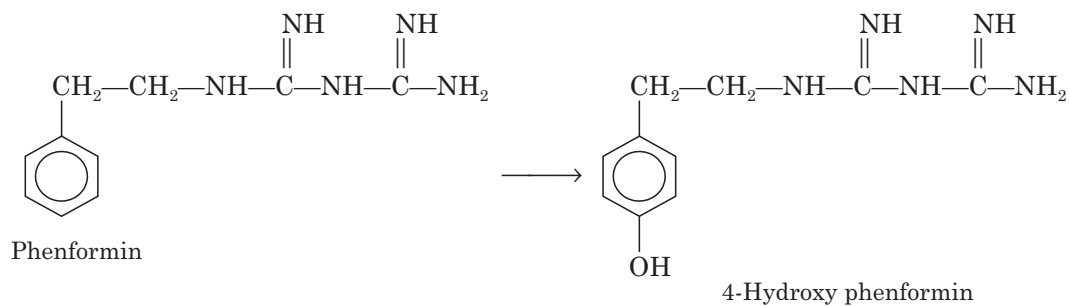

Oxidation of benzylic carbons

The carbons directly attached to aromatic rings are oxidized to aldehydes and carboxylic acids via alcohols.

Ex:

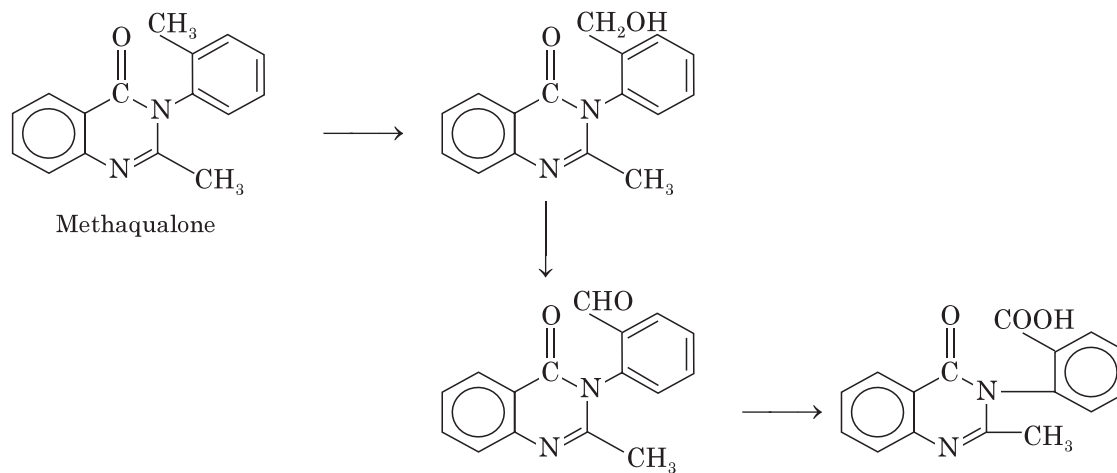
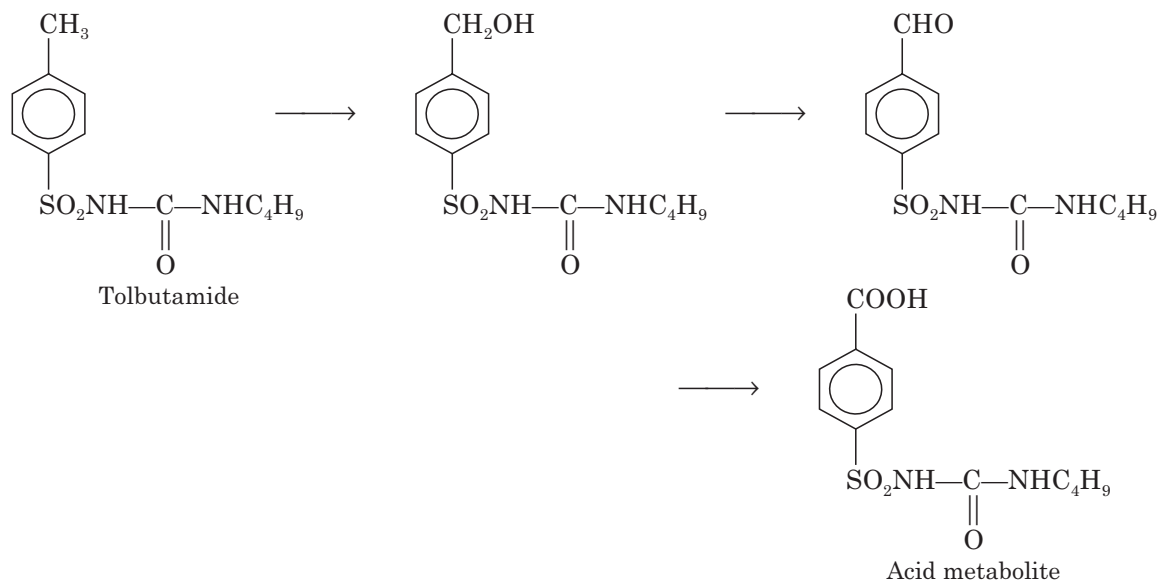

Oxidation of olefins

Drugs possessing carbon-carbon double bonds are oxidized to 1,2-diols through formation of epoxides.

Ex: Carbamazepine is oxidized to trans-10, 11-dihydroxy carbamazepine via carbamazepine-10, 11-epoxide.

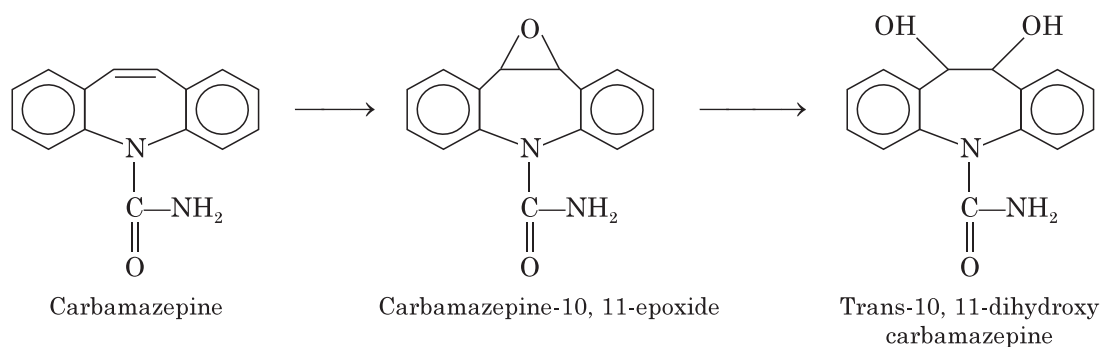

Alcofenac is oxidized to dihydroxyalcofenac.

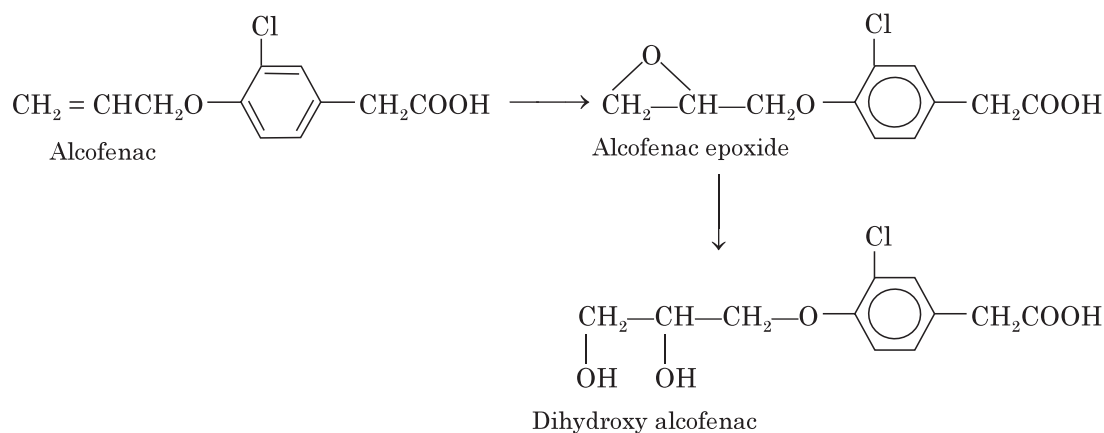

Reductive reactions

Drugs containing carbonyl, nitro, and azo groups are metabolized by reduction to alcohols and amines respectively. The reduced compounds are conjugated and eliminated from the body. Ex :

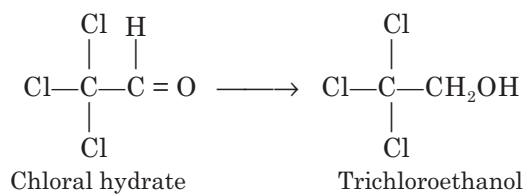

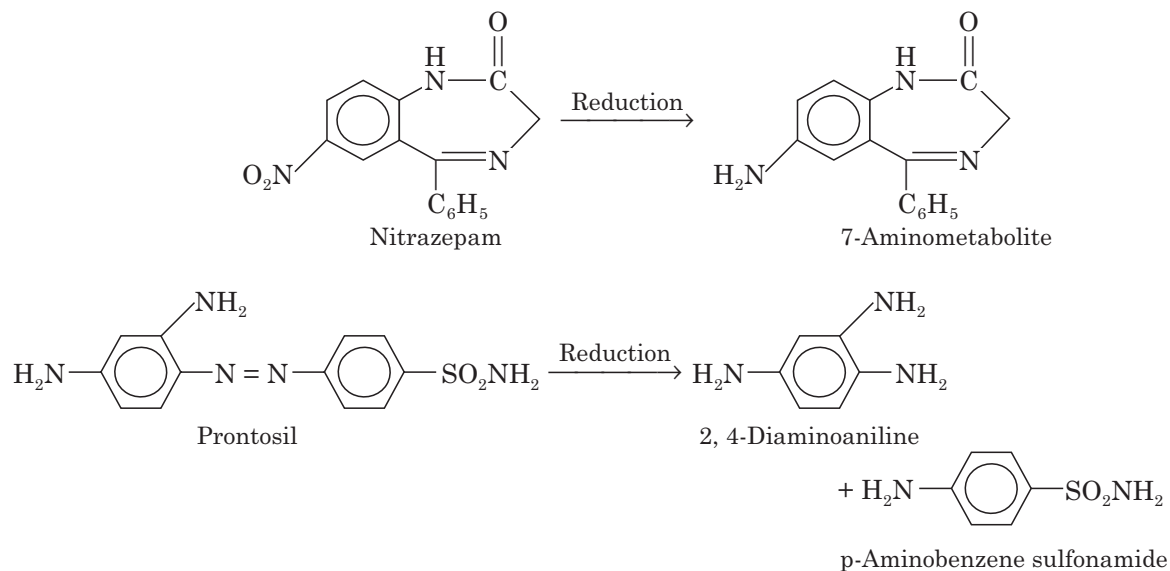

PHASE II : REACTIONS

Conjugation reactions are also known as phase-II reactions. Phase II pathways are synthetic reactions where the product or the metabolite from Phase I gets conjugated. This always produces a large, polar, metabolite that is readily excreted from the body. Some drugs are mainly conjugated and undergo very little oxidative metabolism. Phase II occurs by glucuronidation, sulfation, aminoacid conjugation, acetylation, methylation or glutathione conjugation to facilitate elimination.

Phase II conjugation introduces hydrophilic functionalities such as glucuronic acid, sulfate, glycine, or acetyl group onto the drug or drug metabolite molecules. These reactions are catalyzed by a group of enzymes called transferases. Most transferases are located in cytosol, except the one facilitates glucuronidation, which is a microsomal enzyme. This enzyme, called uridine diphosphate glucuronosyltransferase (UGTs), catalyzes the most important phase II reaction, glucuronidation.

Glucuronidation. Glucuronidation involves conjugation of metabolite or drug molecule with glucuronic acid. In these reactions glucuronic acid molecule is transferred to the substrate from a cofactor (uridine-5¹-diphospho- α -D-glucuronic acid). Glucuronidation is catalyzed by various microsomal glucuronyl transferases. Glucuronides are generally inactive and are rapidly excreted into the urine and bile. Molecules associated with phenolic hydroxyl, alcoholic hydroxyl, and carboxylic acid groups undergo glucuronidation reaction.

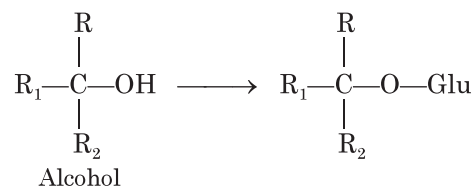

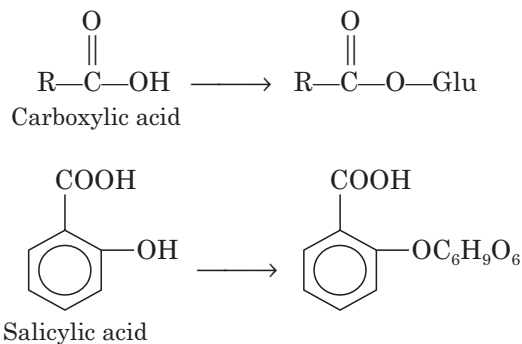

Sulfate Conjugation

Sulfate conjugation involves transfer of a sulphate molecule from the cofactor (3¹-phosphoadenosine-5¹-phosphosulfate) to the substrate (metabolite or drug moiety) by the enzymes (sulfotransferases). Sulphate conjugation is the common conjugation reactions of substrate molecules possessing of alcoholic hydroxyl, phenolic hydroxyl and aromatic amine groups. Ex:

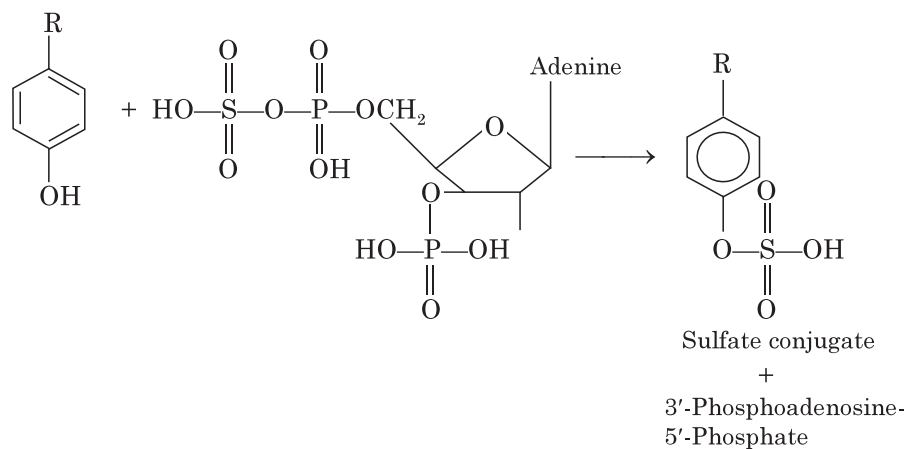

Hydrolysis. Hydrolysis is also observed for a wide variety of drugs. The enzymes involved in hydrolysis are esterases, amidases, and proteases. These reactions generate hydroxyl or amine groups, which are suitable for phase II conjugation.

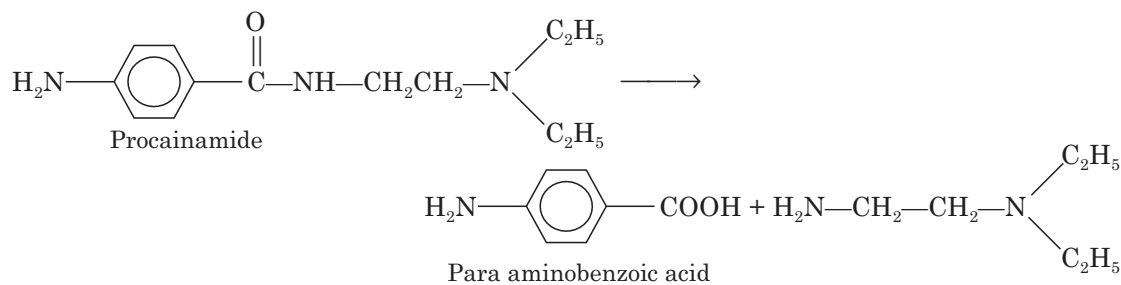

Acetylation. Acetylation is an important metabolic pathway for drugs containing primary amino groups. The acetylated conjugates are generally non-toxic and inactive. Ex: histamine, procainamide, para aminosalicylic acid (PAS), hydralazine, isoniazid.

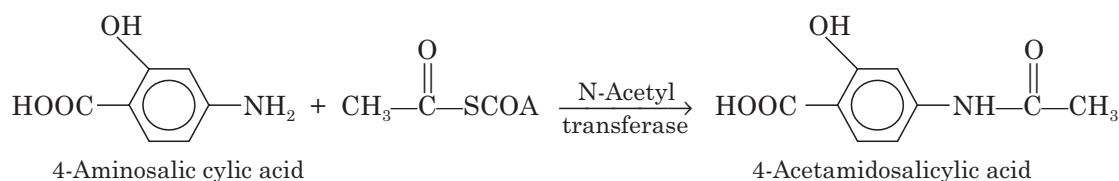

CYTOCHROME P450 REDUCTASE

The cytochromes P450s [CYPs] are membrane bound proteins with an approximate molecular weight of 50 kD, and contain a heme moiety. There are about 30 human cytochrome P450 enzymes out of which only six, CYP1A2, CYP2C9, CYP2C19, CYP2D6, CYP2E1 and CYP3A4 are the metabolising enzymes. The following table shows the major CYPs involved in the metabolism of some known drugs.

Enzyme	Substrates
CYP1A2	Amitriptyline, Betaxolol, Caffeine, Clomipramine, Clozapine, Chlorpromazine, Fluvoxamine, Haloperidol, Imipramine, Olanzapine, Ondansetron, Propranolol, Tacrine, Theophylline, Verapamil, (R)-Warfarin
CYP2A6	Coumarin, Betadiene, Nicotine
CYP2C9	Amitriptyline, Diclofenac, Demdex, Fluoxetine, Ibuprofen, Losartan, Naproxen, Phenytoin, Piroxicam, Tolbutamide, (S)-Warfarin
CYP2C19	Amitriptyline, Citalopram, Clomipramine, Diazepam, Imipramine, Omeprazole
CYP2D6	Amitriptyline, Betaxolol, Clomipramine, Codeine, Clozapine, Desipramine, Fluoxetine, Haloperidol, Imipramine, Methadone, Metoclopramide, Metoprolol, Nortriptyline, Olanzapine, Ondansetron, Paroxetine, Propranolol, Risperidone, Sertraline, Timolol, Venlafaxine
CYP2E1	Acetaminophen, Caffeine, Chlorzoxazone, Dextromethorphan, Ethanol, Theophylline, Venlafaxine
CYP3A4/5	Alprazolam, Amiodarone, Amitriptyline, Astemizole, Bupropion, Buspirone, Caffeine, Carbamazepine, Ceruvastatin, Cisapride, Clarithromycin, Clomipramine, Codeine, Cyclosporine, Dexamethasone, Dextromethorphan, DHEA, Diazepam, Diltiazem, Donepazil, Doxy cycline, Erythromycin, Estradiol, Felodipine, Fluoxetine, Imipramine, Lansoprazole, Lidocaine, Loratadine, Lovastatin, Midazolam, Niacardipine, Nifedipine, Omeprazole, Orphenadrine, Paroxetine, Progesterone, Quinidine, Rifampin, Sertraline, Sibutramine, Sildenafil, Simvastatin, Tacrolimus, Tamoxifen, Terfenadine, Testosterone, Theophylline, Verapamil, Vinblastine, (R)-Warfarin

The cytochromes P450, involves in the metabolism of many drugs and dietary substances, and in the synthesis of steroid hormones and other extracellular lipid signalling molecules.

FACTORS AFFECTING DRUG METABOLISM

A number of factors may influence the rate of drug metabolism. They are ;

1. **Physicochemical properties of drugs.** Molecular size, shape, acidity or basicity, lipophilicity, pKa, and steric and electronic characteristics of drugs influence its interaction with the active sites of enzymes.

2. **Chemical factors.** A large number of chemical substances such as drugs, insecticides etc. can increase the rate of drug metabolism due to increased rate of formation of newer enzymes or decreased rate of degradation of drug metabolising enzymes. Ex. Alcohol enhances metabolism of phenobarbitone, phenytoin etc.

3. **Diet.** The enzyme content and activity is altered by a number of dietary compounds. Fat free diet depresses cytochrome P450 levels since phospholipids, which are important components of microsomes become deficient.

4. **Genetic or hereditary factors.** Genetic and hereditary factors are the most significant factors in drug metabolism. Genetic differences among individuals or ethnic groups can lead to an excessive or prolonged therapeutic effect or toxic overdose.

Ex: The enzyme CYP2D6 metabolises a large number of drugs. The activity of this enzyme varies widely among ethnic groups. About 1% of Arabies, 30% Chinese and 7-10% caucasians are poor metabolizers of CYP2D6 drugs.

5. **Environmental factors:** Environmental factors such as smoking, alcohol consumption and concomitant drug therapy also influence the outcome of drug metabolism.

Ex: Cigarette smoke produces polynuclear aromatic hydrocarbons. CYP1A2 metabolises the polynuclear aromatic hydrocarbons to carcinogens responsible for lung and colon cancer.

6

General Anesthetics

INTRODUCTION

General anesthetics are the drugs, which produce controlled, reversible depression of the functional activities of the central nervous system producing loss of sensation and consciousness.

Stages of General Anesthesia. When an inhalation anesthetic is administered to a patient some of the following well defined stages are produced by increasing the blood concentration of the agent. They are ;

- Stage I (Stage of analgesia): This is the period from the beginning of anesthetic administration to the loss of consciousness. The patient progressively loses pain. This stage is also called stage of analgesia.
- Stage II (Stage of delirium): This period extends from the loss of consciousness through a stage of irregular and specific breathing to the reestablishment of regular breathing. Respiration is normal and regular. The patient may laugh, vomit or struggle and for this reason it is called the stage of excitement.
- Stage III (Stage of surgical anesthesia): In this stage excitement is lost and skeletal muscle relaxation is produced. Most types of surgeries are done in this stage.
- Stage IV (Stage of medullary depression): Overdose of the anesthetic may bring the patient to this stage. Respiratory and circulatory failure occur in this stage.

CLASSIFICATION OF GENERAL ANESTHETICS

The general anesthetics are classified according to their nature (volatile or non-volatile) at room temperature. They are:

A. Volatile Inhalation general anesthetics. They are administered by inhalation and are further subdivided as;

- **Gases:** Ex: Cyclopropane: Ethyl chloride, Nitrous oxide
- **Liquids:** Diethyl ether, Halothane, Chloroform, Trichloroethylene

B. Non-Volatile or Intravenous anesthetics. They are non-volatile at room temperature and are administered by intravenous route. They are;

- **Barbiturates :** Thiopental sodium, Methohexital sodium.
- **Non-barbiturates :** Propanidid, Propofol.

INDUCTION OF GENERAL ANESTHESIA

Barbiturates induce general anesthesia rapidly and pleasantly (painlessly). They have maximum effect in about 1 minute and duration about 5-8 minutes. Induction doses produce the highest blood concentration, the greatest effects on body systems and the most side effects. Usual, recommended induction doses of thiopental:

adults	2.5-4.5 mg/kg
children	5-6 mg/kg
infants	7-8 mg/kg

Since, some individuals seem “particularly sensitive” to thiopental, a conservative technique might be to inject 1/4 of the calculated (above) dose and observe patient response. If this smaller dose has great effect, reduce calculated subsequent dose.

CHARACTERISTIC FEATURES OF IDEAL GENERAL ANESTHETIC

An ideal general anesthetic should possess the following characteristic features:

- It should be inert
- It should be potent and non-inflammable
- It should be non-irritating to mucous membrane
- It should produce rapid and smooth anesthesia
- It should produce analgesia and muscle relaxation in addition to anesthesia
- It should not produce severe hypotension
- It should not produce nausea and vomiting
- It should be compatible with adjuvant drugs used in anesthesia
- It should be economical
- It should be stable to heat, light and alkalis

MECHANISM OF ACTION OF GENERAL ANESTHETICS

The general anesthetics inhibit CNS neuronal activity. But their precise mechanism of neuronal inhibition is not clear. Several mechanisms were proposed to explain general anesthesia. They are:

(i) **Lipid Theory.** According to this theory the more lipid soluble general anesthetics concentrate in hydrophobic regions of neuronal cell membrane and causes swelling of these membranes. Due to this swelling of structure of membrane alters, thereby blocks the Na⁺ channels. Thus the generation of action potential is inhibited and produces anesthesia. In 1901, Meyer and Overton correlated the potency of general anesthetics with their lipid solubility. The higher the value of partition coefficient of the compound, more will be its general anesthetic potency.

(ii) **Protein Theory.** According to this theory the anesthetic bind to the hydrophobic sites of protein molecules of neuronal cell membrane, thus the membrane function is altered and produces anesthesia.

SPECIFIC GENERAL ANESTHETICS

CYCLOPROPANE

Chemistry. Cyclopropane is a cyclic aliphatic hydrocarbon. It is prepared from 1, 3-dibromopropane with zinc and alcohol in absence of water.

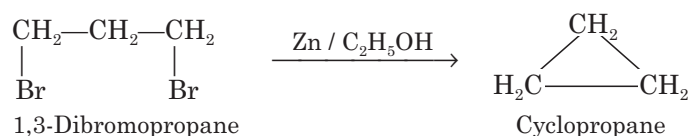

Properties

- Cyclopropane is a colourless flammable gas with characteristic odour and pungent taste. It is supplied in compressed form in metal cylinders
- Cyclopropane forms explosive mixture with air
- The cylinders of cyclopropane are painted red

Uses. Cyclopropane is used as general anesthetic. It produces rapid and smooth induction, good muscle relaxation and has wide margin of safety. It is administered by inhalation.

ETHYL CHLORIDE:

Chemistry. Ethyl chloride is a chloro derivative of ethane. It is gas at normal conditions and is available in compressed form. Ethyl chloride is prepared from ethyl alcohol by passing dry hydrogen chloride into it.

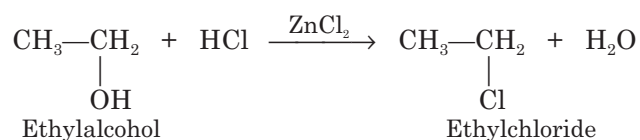

Properties

- Ethyl chloride is a volatile liquid having a pleasant ethereal odour and burning taste
- It is slightly soluble in water and also miscible with alcohol and ether

Uses. Ethyl chloride is used as a general anesthetic administered by inhalation.

NITROUS OXIDE

Chemistry. Nitrous oxide was the first anesthetic. Joseph Priestly first reported nitrous oxide preparation in 1772. It is prepared by heating ammonium nitrate to 200°C.

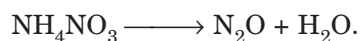

Properties

- Nitrous oxide is available as a colourless, tasteless and odourless gas
- It is supplied in blue coloured metal cylinders
- It is soluble in water, alcohol and ether

Uses

- Sir Humphry Davy in 1800 was first recognized its anesthetic properties. Nitrous oxide is used to induce anesthesia and is followed by ether, halothane or methoxy flurane
- It is also used for short dental operations

DIETHYL ETHER

Chemistry. Diethyl ether was the first compound to be used as an anesthetic by American doctor. In 1846, James Simpson popularized the use of ether as an anesthetic in surgical operations. It is prepared in the laboratory and on the large scale by heating mixture of ethyl alcohol in presence of H_2SO_4 and purified with sodium hydroxide followed by drying on anhydrous calcium chloride.

**Properties**

- Diethyl ether is a colourless, volatile, highly inflammable liquid, having sweet burning taste and characteristic odour
- The anesthetic ether should be stored in well-closed, light resistant containers in a cool place
- Stabilizers like sodium pyrogallate, hydroquinol, or propylgallate are added to anesthetic ether

Uses

- It is a safe general anesthetic
- It is inexpensive

HALOTHANE

Chemistry. Chemically halothane is 2-bromo, 2-chloro, 1,1,1-trifluoroethane. It is prepared from trichloroethylene by the following chemical reactions.

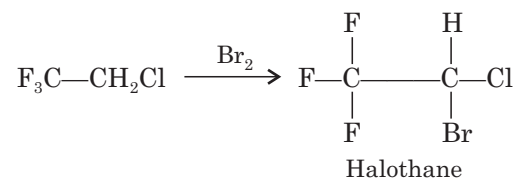
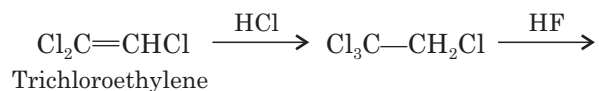
**Properties**

- Halothane is a colourless, non-inflammable liquid having chloroform like odour
- It is non-irritant to the skin and mucous membrane

Uses

- Halothane is one of the most widely used potent anesthetic agents (2-2.5%). It is usually administered through N_2O -air mixture. It has more rapid induction and

recovery compared to ether (generally discouraged as an explosive hazard) and methoxyflurane

- It is more potent than chloroform and ether

Some disadvantages of halothane are;

- It reduces cardiac output
- It causes peripheral vasodilation leading to hypotension or low blood pressure
- It is a dose-dependent respiratory depressant

CHLOROFORM

Chemistry. Chloroform is an important halogenated hydrocarbon. It is prepared from bleaching powder and ethyl alcohol by the following chemical reactions.

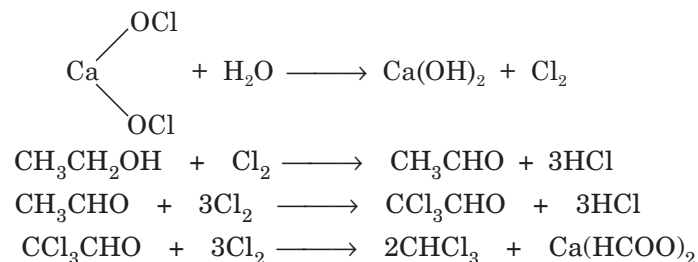

Properties

- Chloroform is a colorless, volatile liquid having characteristic odour and burning taste
- It is non-inflammable and is freely miscible with ether and ethyl alcohol
- Chloroform must be protected from light and air, otherwise poisonous phosgene is formed

Uses

- Chloroform is a widely used general anesthetic agent
- It is used as solvent for fats and oils

TRICHLOROETHYLENE

Chemistry. Trichloroethylene is a trichloro derivative of ethane. It is prepared by the alkaline decomposition of tetrachloroethane.

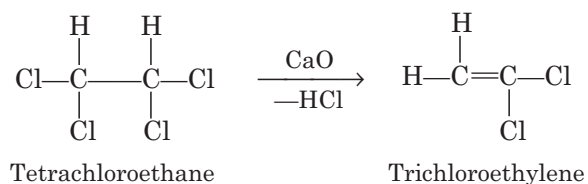

Properties

- Trichloroethylene is a clear colorless liquid, having chloroform like odor and taste
- It contains about 0.008% of thymol as preservative
- It is insoluble in water but it is miscible with alcohol, chloroform and ether

Uses

- It is a weak volatile anesthetic
- It possesses potent analgesic action
- It is recommended for dental extractions, orthopedic manipulations and short surgical procedures

METHOXYFLURANE

Methoxyflurane is the most potent of all inhalation anesthetics. Chemically methoxyflurane is 2,2-dichloro-1,1-difluoro-1-methoxyethane. It is available as a colorless liquid with sweet odor.

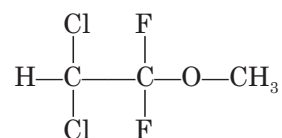

Methoxyflurane is nonflammable, nonexplosive, and a potent analgesic. Low vapor pressure makes it the only agent suitable for the open drop method. A disadvantage of methoxyflurane, compared to other inhalants, is a relatively slow induction phase that can result in a modest respiratory and cardiovascular depression. Perhaps the biggest disadvantage is that metabolization leads to fluoride ion release which is nephrotoxic. An appropriate scavenging system must be in place to protect personnel.

ENFLURANE

Chemically enflurane is 2-chloro-1,1,2-trifluoroethyl difluoromethylether. Enflurane is available as a clear, colourless non-inflammable liquid with sweet odor.

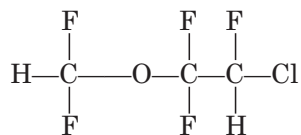

The induction and emergence from anesthesia of enflurane is smooth and moderately rapid.

It is used as an alternative to halothane.

ISOFLURANE

Isoflurane is an isomer of enflurane. Chemically isoflurane is 2-chloro-2-(trifluoromethoxy)-1,1,1-trifluoroethane. It is available as clear, colourless liquid at room temperature, with sweet taste. It is miscible with organic liquids including fats and oils. Isoflurane is nonflammable and nonexplosive.

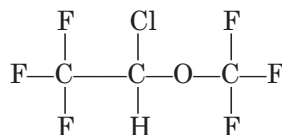

Isoflurane has a more rapid induction and emergence than halothane.

It has higher margin of safety than enflurane or halothane.

Compared to halothane, isoflurane causes :

- less depression of cardiopulmonary function
- less sensitization of the heart to catecholamine (β -adrenoceptor agonist) release
- less profound respiratory depressant effect

Isoflurane reduces renal blood flow, glomerular filtration rate and urinary flow. Isoflurane's metabolism to organic and inorganic flourides is less than any other halogenated agent available, so if a minimally metabolized anesthetic is needed, isoflurane is the choice.

THIOPENTONE

Chemistry. Thiopentone is an intravenous anesthetic. It is a barbituric acid derivative and is synthesized by condensing thiourea with ethyl (ethyl 1-methyl butyl) malonate.

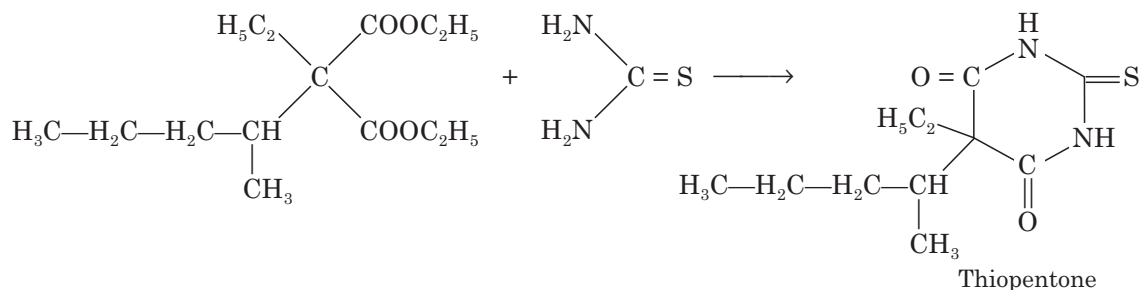

Properties

- Thiopentone is available as thiopentone sodium
- It is a yellowish hygroscopic powder, having characteristic odour and bitter taste

Uses

- Thiopentone sodium solutions (2.5%) are administered by intravenous route to produce anesthesia. It has short duration of actions
- It is also used to control convulsions

METHOHEXITAL

Chemistry. Methohexital is also a derivative of barbituric acid. It is prepared by condensation of ethylcyanoacetate with 2-chloro-3-pentyne in presence of sodium ethylate yields ethyl-1-methyl-2-pentynyl cyanoacetate which on further condensation with allylbromide yields ethyl(1-methyl-2-pentynyl)allylcyanoacetate. Reaction with N-methyl urea yields the iminobarbituric acid which on acid catalyzed hydrolysis forms methohexital.

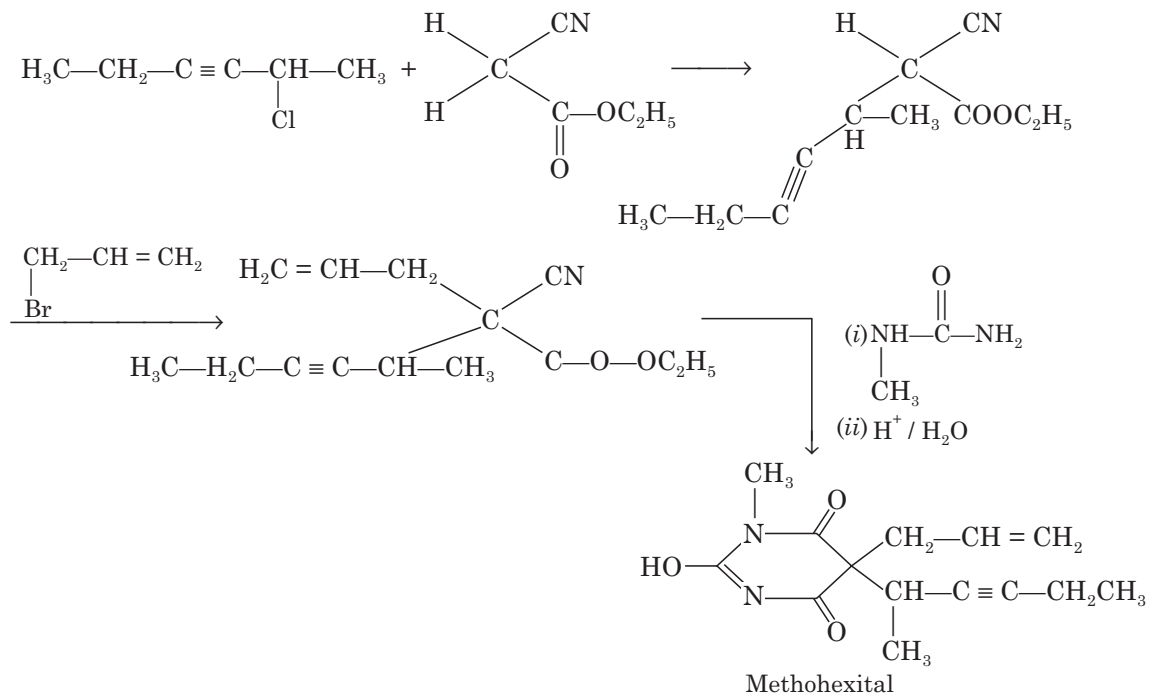

Properties

- Methohexital is available as methohexital sodium
- It is a colourless or slightly yellowish crystalline powder
- Methohexital sodium is freely soluble in water

Uses

- It is used as a general anesthetic and hypnotic. It is administered either by intravenous route or intramuscular route
- It is more potent than thiopentone sodium

PROPANIDID

Chemistry. Propanidid is a non-barbiturate general anesthetic. It has the following structure:

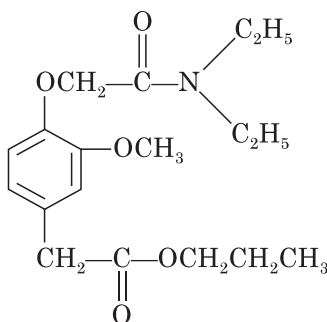

Properties

- Propanidid is available as a colourless or pale greenish-yellow hygroscopic liquid and having a faint odor
- It is slightly soluble in water but miscible with alcohol, chloroform and ether

Uses

- Propanidid has been used as a short acting general anesthetic
- It also possesses local anesthetic activity

KETAMINE

Ketamine is a cyclohexanol derivative. Chemically ketamine is (+) 2 (*o*-chlorophenyl)-2-methylaminocyclohexanone. Ketamine is prepared by Grignard reaction of *o*-chlorobenzonitrile with bromocyclopentane in presence of strong alkali to form an epoxy compound, which converts to an imine by the action of methylamine. The imine rearranges to ketamine on heating with HCl.

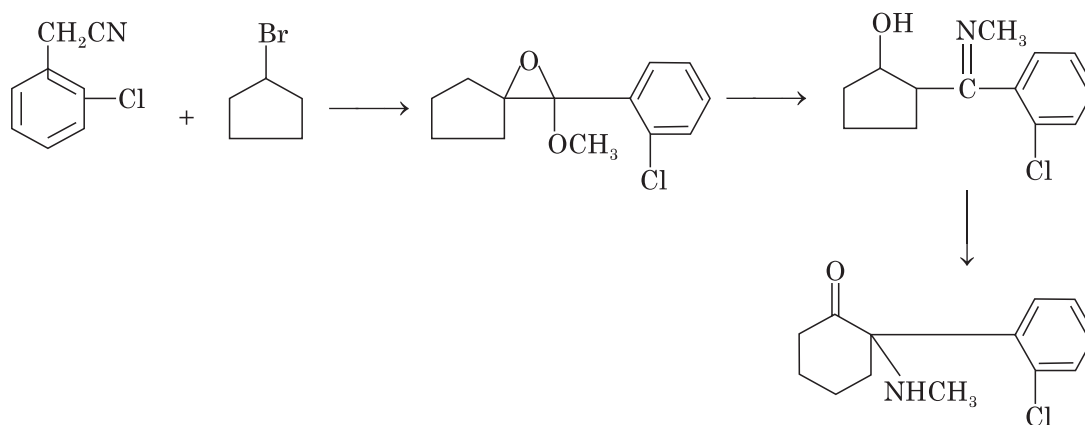

Ketamine is available as colorless crystalline compound having characteristic odor. It melts at 258°C.

Uses :

- Ketamine is used as a general anesthetic
- It also has analgesic effect
- Ketamine relaxes skeletal muscles

PROPOFOL

Propofol is a liquid short-acting general anesthetic. Chemically it is 2, 6-diisopropylphenol.

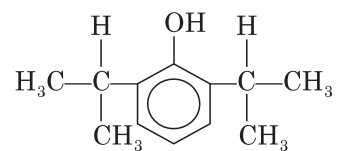

7

Sedative-Hypnotic Drugs

INTRODUCTION

In general sedative-hypnotics are drugs used to slow down mental and physical functions of the body. These are also referred to as the CNS depressants. Sedatives are chemical agents tend to produce a calming effect, relax muscles, and relieve feelings of tension, anxiety, and irritability.

At higher doses, most of these sedative drugs will also produce drowsiness and eventually produce sleep. Drugs that have such a sleep-inducing effect are called hypnotic drugs or hypnotics. There is, no sharp distinction between sedative and hypnotic and the same drug may have both actions depending on the method of use and the dose employed. However, the combination of the terms sedative-hypnotic appropriately identifies the major pharmacological effects of these drugs. In reality, almost any drug that calms, soothes, and reduces anxiety is also capable of relieving insomnia.

Although the narcotics and sedative-hypnotics share many of the same actions, the latter drugs have no practical pain-relieving properties. Unlike the narcotics, intoxicating doses of the sedative-hypnotics almost always result in impaired judgement, slurred speech, and loss of motor function.

CLASSIFICATION OF SEDATIVE-HYPNOTICS

Due to chemical differences, the sedative-hypnotics include several related families of drugs having common characteristics but somewhat diverse effects and therapeutic uses. These drugs are classified as follows ;

1. Barbiturates : Ex: Phenobarbitone, pentobarbitone, amobarbitone etc.
2. Non-barbiturates : They are further classified as follows ;
 - (a) Aldehydes and their derivatives : Chloral hydrate, paraldehyde, triclofos sodium
 - (b) Piperidine derivatives : Glutethimide, methyprylone
 - (c) Quinazoline derivatives : Methaqualone
 - (d) Alcohols and their carbamate derivatives : Ethchlorvynol, meprobamate, ethinamate
 - (e) Benzodizepine derivatives : Chlordiazepoxide, diazepam, oxazepam, alprozolam, flurazepam, triazolam, prazepam, halazepam, temazepam, lorazepam

BARBITURATES

Description

Barbiturates are central nervous system (CNS) depressants (medicines that cause drowsiness). Barbiturates produce a wide spectrum of CNS depression, from mild sedation to coma, and have been used as sedatives, hypnotics, anesthetics and anticonvulsants. But, they can be addictive and abused. Excessive doses can cause depression, slurred speech, slowed reflexes and confusion.

Barbiturates were first introduced for medical use in the early 1900s. More than 2,500 barbiturates have been synthesized, and in the height of their popularity about 50 were marketed for human use. Today, only about a dozen are used.

Barbiturate Development

In 1864 von Baeyer synthesized the first barbiturate, **barbituric acid**. The first hypnotic barbiturate, **diethylbarbituric acid**, was synthesized by Fischer and Mering in 1903. A number of other hypnotic-sedative barbiturates were developed and tested, but all had too slow onset and too long duration of action. In 1932 Weese and Schapff synthesized the first rapid onset, short duration barbiturate, the methylated oxybarbiturate **hexobarbital**. Unfortunately, hexobarbital caused undesirable excitatory side effects. **Thiopental** was first administered by Waters (Wisconsin) and Lundy (Mayo Clinic) in 1934. Thiopental proved to be fast and brief acting and devoid of excitatory side effects. In 1950 Brodie et al demonstrated that barbiturate hypnotic-sedative activity was terminated not by metabolism, but by redistribution from central neural sites of action to other body tissues. It was later shown (Price, 1960) that during prolonged infusions, redistribution becomes less effective because redistribution sites approach equilibrium.

Classification of Barbiturates

Barbiturates are classified as ultra short, short, intermediate and long acting based on their duration of action ;

- (i) Ultra short acting barbiturates: The ultra short acting barbiturates produce anesthesia within about one minute after intravenous administration. Those in current medical use are methohexital, thiamylal and thiopental.
- (ii) Short acting barbiturates: Action starts within 1/2 hour and lasts for about 4 hours. Ex: Pentobarbitone, quinalbarbitone, secobarbitone, cyclobarbitone
- (iii) Intermediate acting barbiturates: Action starts within 1/2 hour and lasts for about 6 hours. Ex: Allobarbitone, butobarbitone, amylobarbitone
- (iv) Long acting barbiturates: Action starts within 1/2 hour and lasts for 8 hours. Ex: Barbitone, phenobarbitone and methylphenobarbitone. They are primarily used for daytime sedation and the treatment of seizure disorders or mild anxiety.

Barbiturates, are usually taken orally but are sometimes injected intravenously or intramuscularly. They are absorbed rapidly; 30-40% is bound to plasma protein, and the rest is distributed to muscle, fat, and the liver (where they are ultimately inactivated).

Chemistry of Barbiturates

1. Barbiturates are derivatives of barbituric acid (2,4,6-trioxypyrimidine) which is devoid of hypnotic and sedative activities.

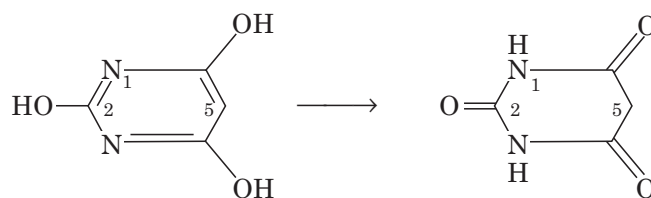

Keto-enol tautomerism of barbituric acid

2. Barbituric acid may be described as a “cyclic ureide of malonic acid”. Barbituric acid can be made by condensing urea with ethyl malonate in presence of sodium ethoxide.

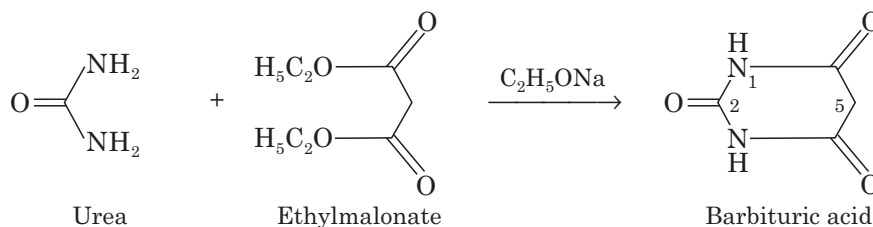

3. Clinically important hypnotic-sedative barbiturates have substitutions at sites 1, 2 and, especially, 5 of barbituric acid.

4. Keto-enol tautomerism of barbituric acid and barbiturates allows formation of water-soluble salts with a strong base.

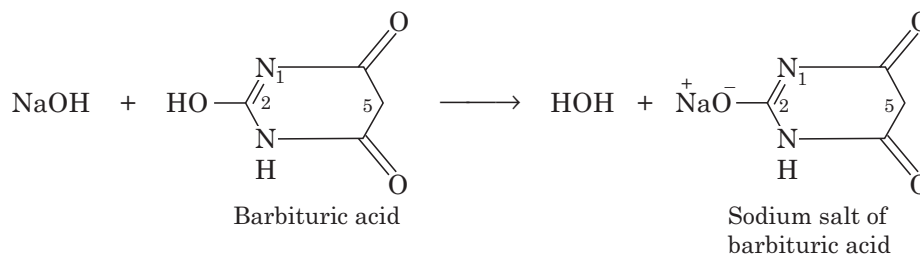

5. The barbiturates do not dissolve readily in water, their sodium salts dissolve readily in water.

6. Buffering action of Na_2CO_3 plus atmospheric CO_2 maintains pH at 10 to 11. In less alkaline solutions, these barbiturates may precipitate as the free acids; so do not reconstitute barbiturates with normal saline and do not mix with acidic solutions of other drugs.

Structure-Activity Relationships of Barbiturates

1. **Hypnotic activity.** Side chains at position 5 (especially if one of them is branched) is essential for activity.

2. **Potency and duration of action.** Length of side chain at position 5 influences potency and duration of action. Ex: Secobarbital and thiamylal are slightly more potent than pentobarbital and thiopental, respectively.
3. **More rapid onset and shorter duration of action.** Sulfur instead of oxygen atom at position 2 has more rapid onset of action but shorter duration. Ex: thiamylal and thiopental have more rapid onset and shorter duration of action than secobarbital and pentobarbital, respectively.
4. **Increased incidence of excitatory side effects.** Methylation at position 1 (methohexital) enhances excitatory side effects.
5. **Increased potency, rate of onset and short action.** Generally an increase in the lipophilicity of the compound results in more rapid onset of action accompanied with an increase in potency.
6. Introduction of polar groups (hydroxyl, keto, amino, or carboxyl) into C-5-alkyl side-chain makes the compound more hydrophilic in nature. Due to the polar nature, hydrophilic barbiturates do not dissolve in microsomal membranes of liver and are excreted.
7. Branched, cyclic or unsaturated side chain at C-5 position generally reduce the duration of action due to an increased ease of metabolic conversion to a more polar, inactive metabolite.
8. **Stereoisomerism.** Though their *l*-isomers are nearly twice as potent as their *d*-isomers, barbiturates are marketed as **racemic mixtures**. Methohexital has two asymmetric carbon atoms, so exists as 4 stereoisomers (alpha,beta-*d*, *l*-methohexital). The beta isomers are associated with extensive motor activity, so methohexital is marketed as **racemic alpha-d, l-methohexital**. Different activities among different stereoisomers (enantiomers or enantiomorphs) is consistent with site of action at a chiral center of a receptor or enzyme.

Mechanism of Action of Barbiturates

Most likely site of action of barbiturates is gamma-aminobutyric acid (GABA) receptor complex. GABA is the principal inhibitory neurotransmitter in the mammalian CNS. GABA receptor complex is made of 4 to 6 glycoprotein subunits assembled to form a ligand-gated chloride ion channel

Barbiturates enhance and mimic the action of GABA at the GABA receptor complex. Barbiturate binding to this receptor decreases the rate of GABA dissociation and increases the duration of GABA-activated chloride channel opening. At slightly higher concentrations, barbiturates directly activate chloride channel opening even in the absence of GABA, leading to "barbiturate anesthesia."

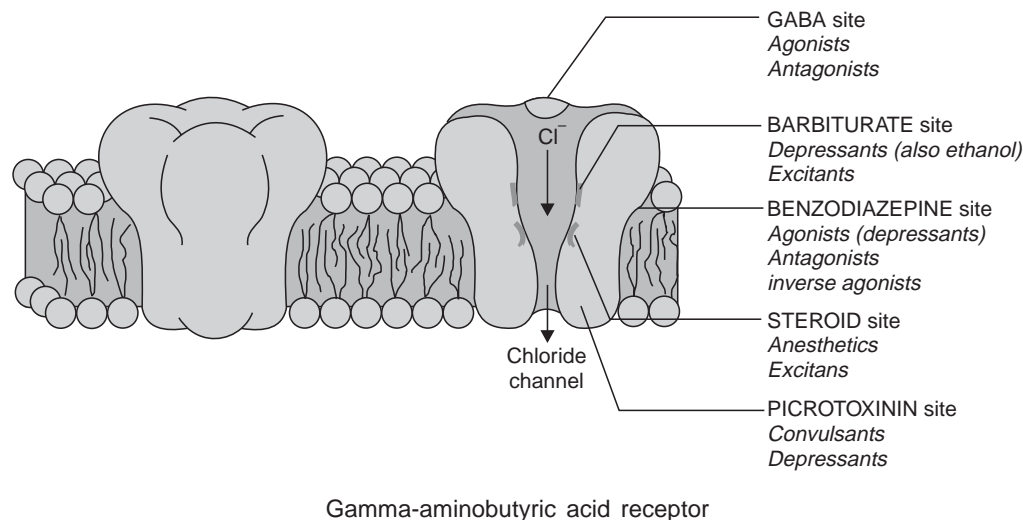

Side-effects of Barbiturates

Side effects of barbiturates include hangover with drowsiness, dizziness, ataxia, respiratory depression, hypersensitivity reactions, headache, particularly in elderly; paradoxical excitement and confusion occasionally precede sleep.

Uses of Barbiturates

1. Barbiturates may be used before surgery to relieve anxiety or tension.
2. In addition, some of the barbiturates are used as anticonvulsants to control seizures in certain disorders or diseases, such as epilepsy.
3. The barbiturates have been used to treat insomnia (trouble in sleeping); but if they are used regularly (for example, every day) for insomnia, they are usually not effective for longer than 2 weeks.
4. The barbiturates have also been used to relieve nervousness or restlessness during the daytime. However, the barbiturates have generally been replaced by safer medicines for the treatment of insomnia and daytime nervousness or tension. If too much of a barbiturate is used, it may become habit-forming. Barbiturates should not be used for anxiety or tension caused by the stress of everyday life. These medicines are available in the following dosage forms: capsules, tablets, elixir, injection, suppositories.

Phenobarbitone

Phenobarbitone is 5-ethyl-5-phenylbarbituric acid. It occurs as sodium salt.

Properties. Phenobarbitone sodium is hygroscopic, bitter taste, water soluble, odorless, white crystalline powder.

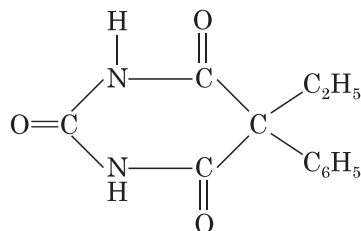

Synthesis. Phenobarbitone is synthesized by the following steps:

1. In the first step a β -keto ester (Ethyl oxalophenylacetate) is prepared by Claisen condensation reaction of ethylphenylacetate with ethylmalonate in presence of sodium.

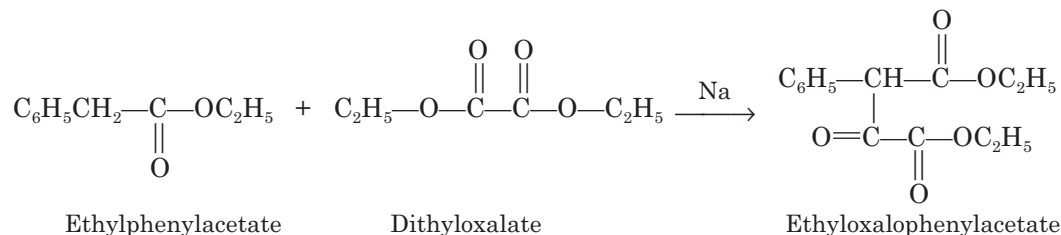

2. The ethyl oxalophenylacetate is then decomposed by distillation to form ethyl phenylmalonate. The ethyl phenylmalonate is further ethylated to form ethyl ethylphenylmalonate with ethyl bromide and ethanol.

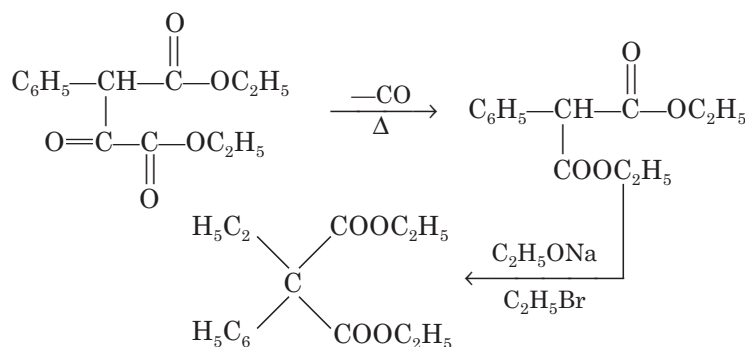

3. The above formed ethyl ethylphenylmalonate is then condensed with urea to form phenobarbitone.

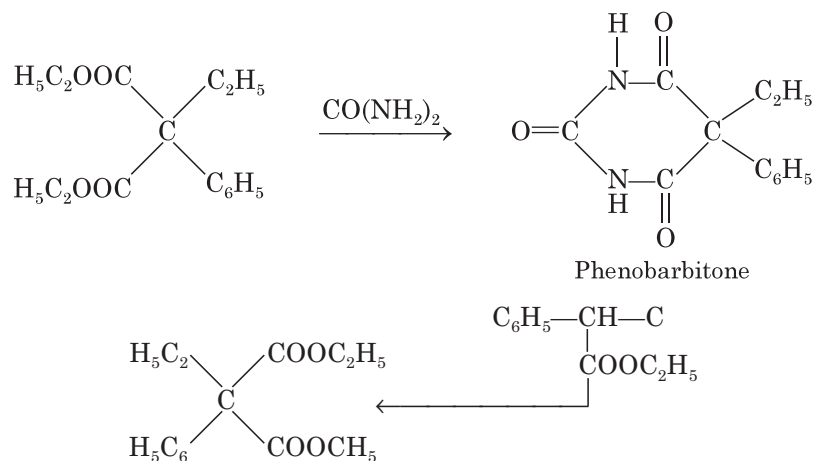

Methylphenobarbitone (Mephobarbital)

Chemistry. Methylphenobarbitone is 5-ethyl-1-methyl-5-phenylbarbituric acid synthesis. Hephobalbyl is prepared by condensing ethylphenylethylmalonate with monomethylurea.

Properties. Mephobarbital is white crystalline, water insoluble powder. It is soluble in aqueous solutions of alkali hydroxides and carbonates.

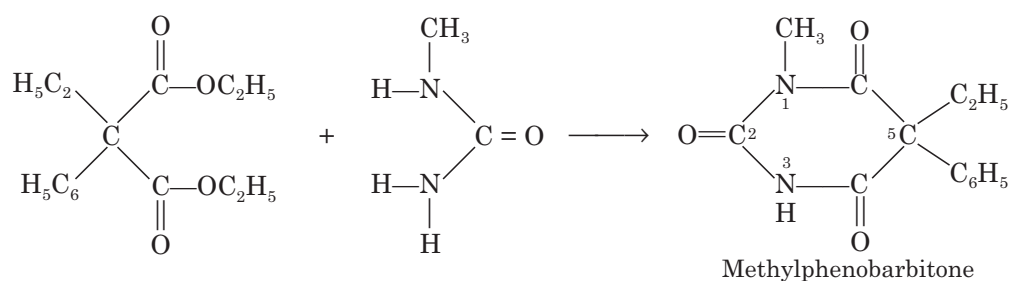

Pentobarbitone

Chemistry. Pentobarbitone is 5-ethyl-5-(1-methylbutyl) barbituric acid. Pento-barbitone is available as pentobarbitone sodium salt. It is prepared by condensing ethyl 1-methylbutylethylmalonate with urea.

Properties. Pentobarbitone and its sodium salt is available as white, crystalline powder. Pentobarbitone is slightly soluble in water, whereas its sodium salt is freely soluble in water.

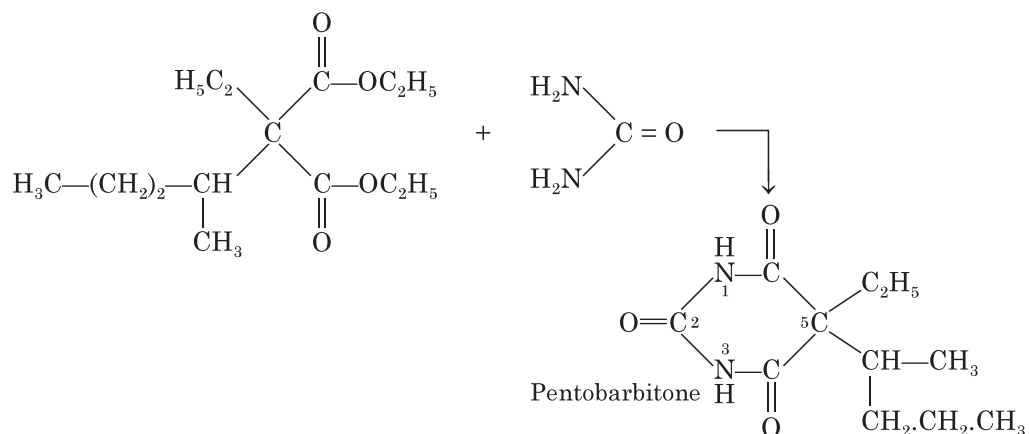

Cyclobarbitone

Chemistry. Cyclobarbitone is a barbituric acid derivative. Chemically it is 5-ethyl-5-(1-cyclohexenyl) barbituric acid.

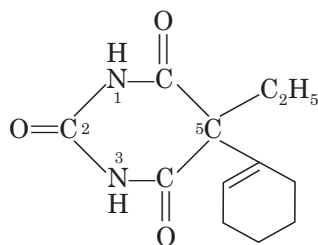

Properties

1. It is available as colorless, bitter taste crystals having the melting point of 174°C.
2. It is very slightly soluble in cold water but freely soluble in hot water. It is also soluble in alcohol, ether etc.

Synthesis. Cyclobarbitone is prepared by the following steps:

1. In the first step ethyl cyclohex-1-enylcyano acetate is synthesized by condensing ethylcyanoacetate with cyclohexanone in presence of sodium ethoxide followed by alkylation with C_2H_5ONa and C_2H_5I .

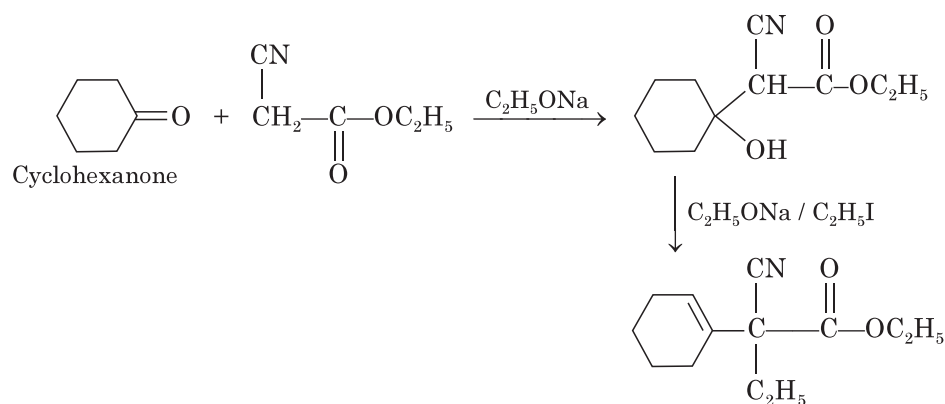

2. The above-formed cyanoester is condensed with urea to get open chain cyanoureaide.

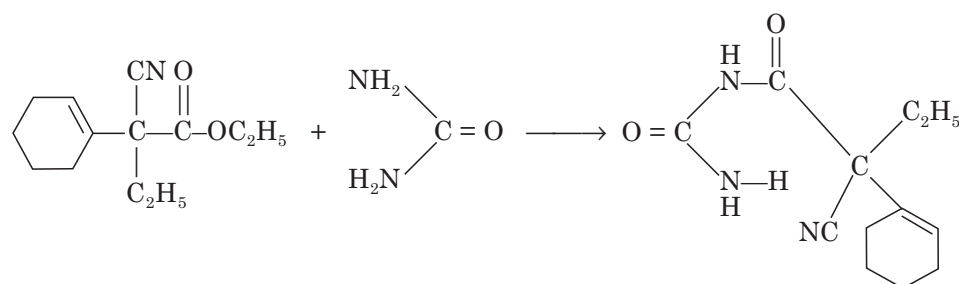

3. The open chain cyanoureaide is hydrolyzed to carboxylic acid and cyclized to cyclobarbitone

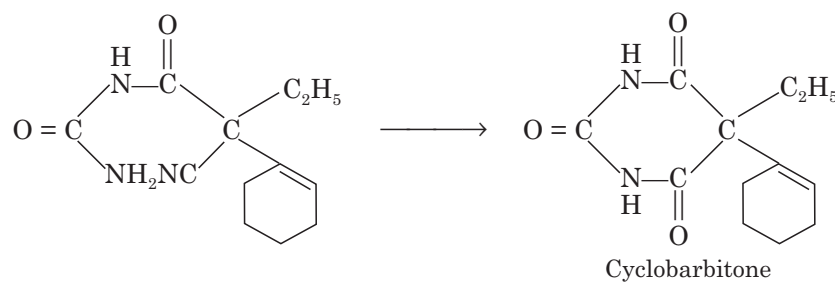

Barbitone

Chemistry. Barbitone is 5,5-diethylbarbituric acid.

Properties. Barbitone is a white crystalline powder. It is slightly soluble in water but freely soluble in aqueous solutions of alkali hydroxides and carbonates.

It is prepared by condensation of ethyl diethylmalonate with urea

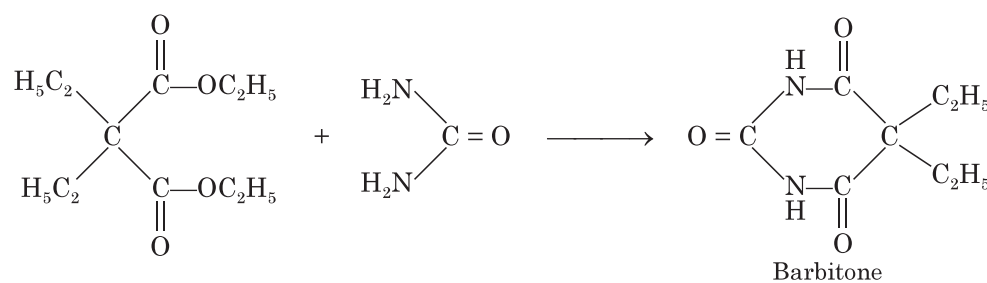
**Butobarbitone**

Chemistry. Butobarbitone is 5-isobutyl-5-ethylbarbituric acid.

Properties. It is white crystalline powder, slightly soluble in water.

It is prepared by condensation of ethylisobutylethylmalonate with urea

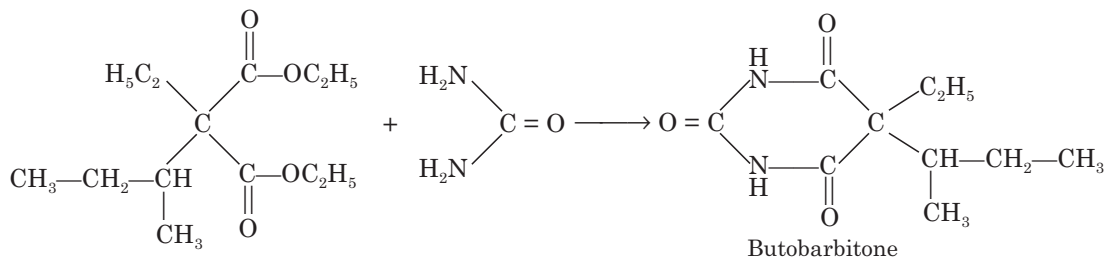
**Amobarbitone**

Chemistry. Amobarbitone is 5-ethyl-5-isopentylbarbituric acid.

Properties. It occurs as white crystalline powder. It is slightly soluble in water but freely soluble in alkali hydroxide and carbonate solutions.

It is prepared by condensation of ethylisopentylethylmalonate with urea

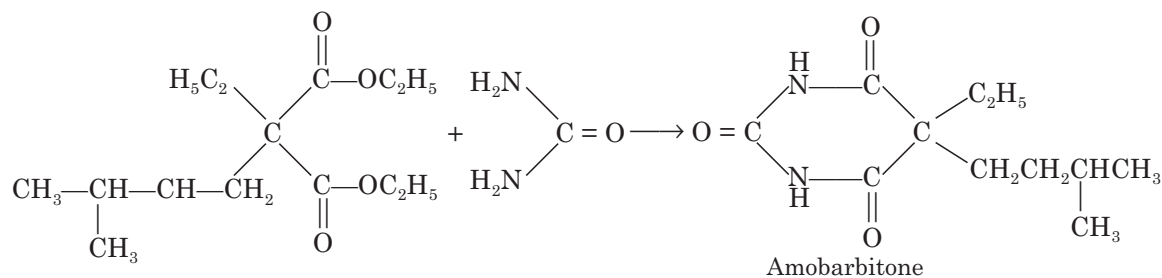

Quinal barbitone (secobarbitone)

Chemistry. Quinalbarbitone is (RS)-5-allyl-5-(1-methylbutyl) barbituric acid. It is prepared by condensing equimolar mixture of urea with ethyl 1-methylbutylmalonate and alkyl bromide.

Properties. Quinalbarbitone occurs as its sodium salt. Quinalbarbitone sodium is a white powder. It is freely soluble in water.

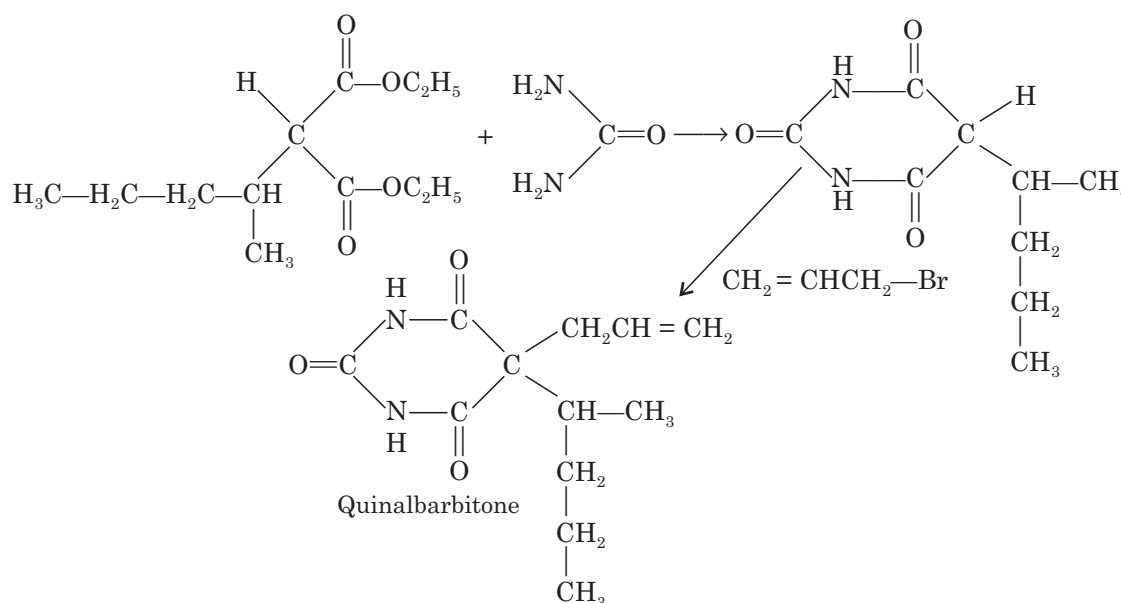
**NON-BARBITURATES**

Numerous heterocyclic derivatives with low toxicity for hypnotic and sedative properties were synthesized. The following are some most important non-barbiturate sedative-hypnotics among piperidines, quinazolinones, aldehydes, benzodiazepines etc.

Glutethimide

Chemistry. Glutethimide is a pyridine derivative. Chemically it is 2-ethyl-2-phenylglutarimide and is a substitute for barbiturates, to treat insomnia. It is fast acting sedative (30 minutes) with a long duration (6 hrs.). Effectiveness lasts for longer a period (5–7 days).

Glutethimide is prepared by the following steps ;

- (i) Glutethimide is prepared by treating benzyl cyanide with ethyl chloride in presence of sodamide to yield α -ethyl benzyl cyanide

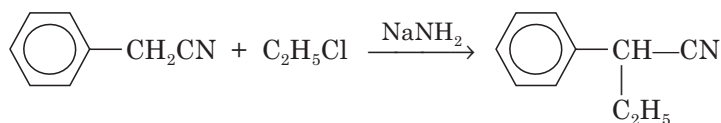

- (ii) The above formed α -ethyl benzyl cyanide is condensed with α -bromopropionic ester to form substituted hexanoic acid.

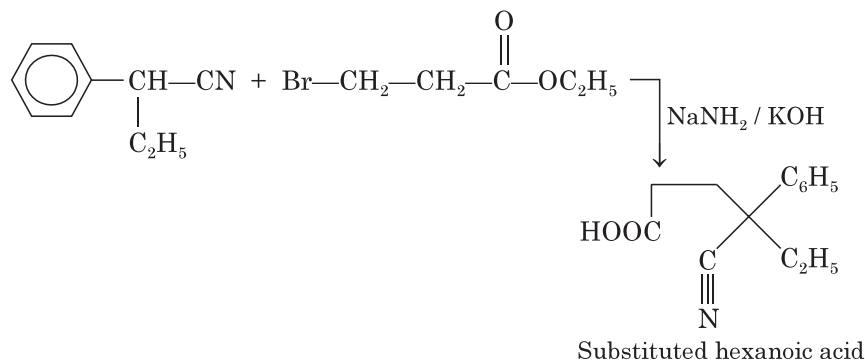

(iii) Cyclization. Substituted hexanoic acid forms the amide on treatment with 80% H₂SO₄ which spontaneously cyclizes to glutethimide.

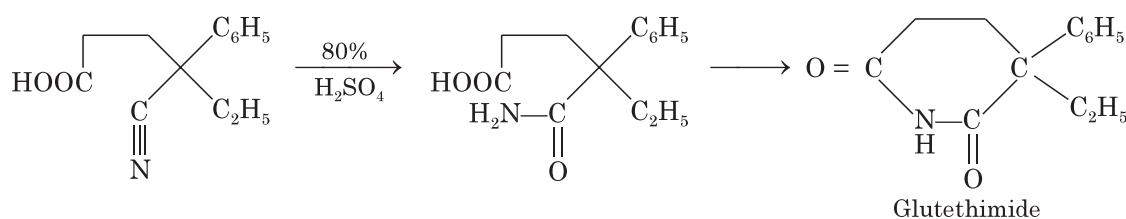

Properties. Gultethimide is colorless or white colored, water insoluble powder. It should be stored in light protected containers.

Uses. Gultethimide is used as hypnotic in all types of insomnia. It induces sleep without depressing respiration.

Methyprylone

Chemistry. Methyprylone is a piperidinedione derivative. Chemically methyprylone is 3, 3-diethyl-5-methylpiperidine-2, 4-dione.

Properties. Methyprylone is a white crystalline powder having characteristic odor. It is sparingly soluble in water but freely soluble in alcohol, chloroform and ether. It should be stored in well-closed containers.

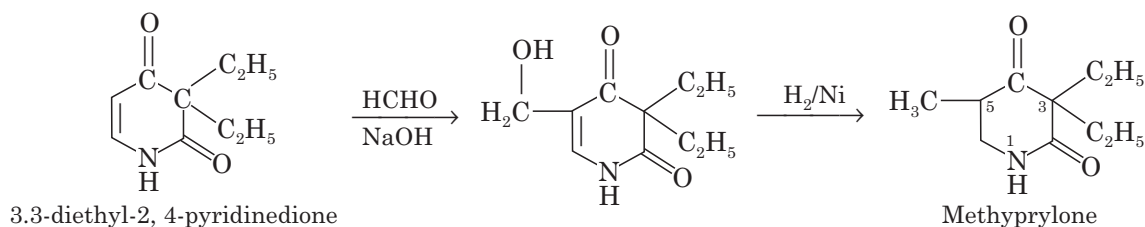

It is prepared by treatment of 3, 3-diethyl-2, 4-pyridinedione with formaldehyde in alkaline medium and catalytic hydrogenation

Uses. Methyprylone is used as a hypnotic to treat insomnia.

Methaqualone

Chemistry. Methaqualone is a quinazolinone derivative. Chemically methaqualone is 2-methyl-3-(2-methylphenyl)-4-quinazolinone. It is prepared by condensation of N-acetyl anthranilic acid with o-toluidine in presence of phosphoryl chloride.

Properties. Methaqualone is white crystalline, water insoluble powder. It should be stored in a light protected container.

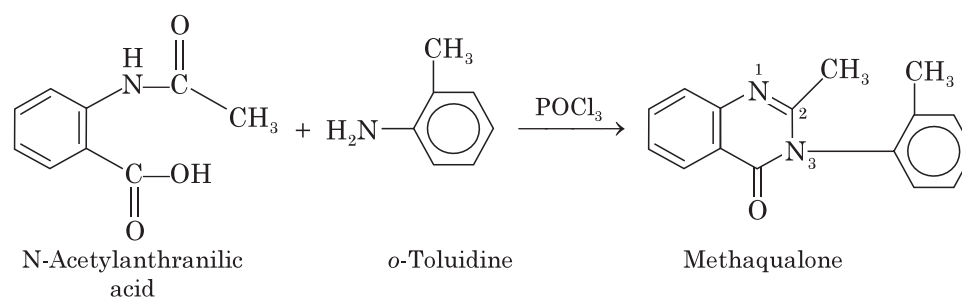

Uses. Methaqualone is used as a hypnotic and as daytime sedative.

Chloral Hydrate (Trichloroacetaldehyde)

Chloral hydrate is a sleep-inducing drug used in the early 1900's but seldom used today. It is not an abused recreational drug, but is often misused by the elderly as a sleep aid. Chloral hydrate is colorless, slightly bitter taste, characteristic odor, and white crystalline powder. Chloral hydrate is prepared by hydration of chloral, which is obtained by the action of chlorine on ethyl alcohol. Chloral hydrate is used as hypnotic to treat insomnia and to allay anxiety as sedative.

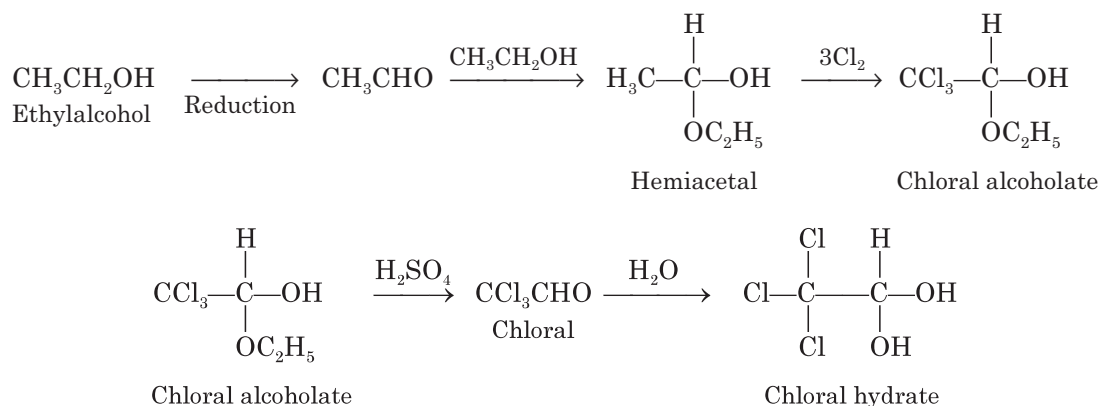

Paraldehyde

Chemistry. Paraldehyde is a cyclic trimer of acetaldehyde. Chemically paraldehyde is 2,4,6-trimethyl-1, 3, 5-trioxane. It is a colorless liquid having strong characteristic odor. It is prepared by condensing 3 molecules of acetaldehyde in presence of small quantities of a catalyst (SO_2 or HCl or ZnCl_2).

Properties. Paraldehyde is available as colorless or pale yellow color liquid. It has strong characteristic odor and is soluble in water. Paraldehyde should be stored in airtight, light protected containers.

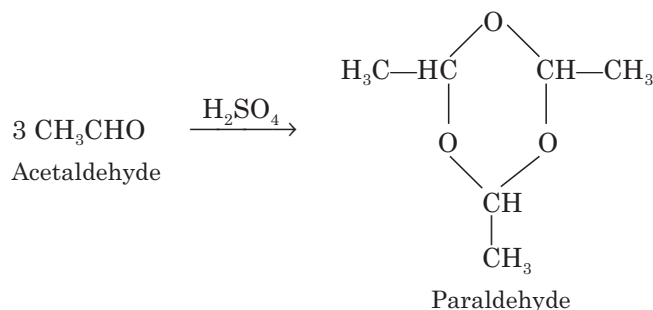

Uses. Paraldehyde is one of the oldest hypnotic. It is used as a hypnotic and sedative.

Triclofos Sodium

Triclofos is 2,2,2-trichloroethylhydrogen orthophosphate, which occurs as its sodium salt. Triclofos sodium is hygroscopic, white colored, water soluble powder. Triclofos is used as hypnotic and sedative.

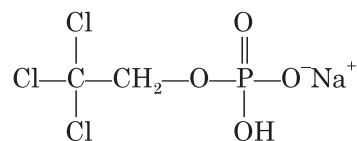

Meprobamate

Chemistry. Meprobamate is 2-methyl-2-propyl trimethylene dicarbamate. Meprobamate is propanediol derivative.

Properties. Meprobamate is an odorless, white colored crystalline aggregate with bitter taste. It is insoluble in water but soluble in alcohol and slightly soluble in ether.

Meprobamate is prepared by condensing 2-methyl 2-*n*-propyl-1,3-propanediol with phosgene at 0°C to get chloroformate diester

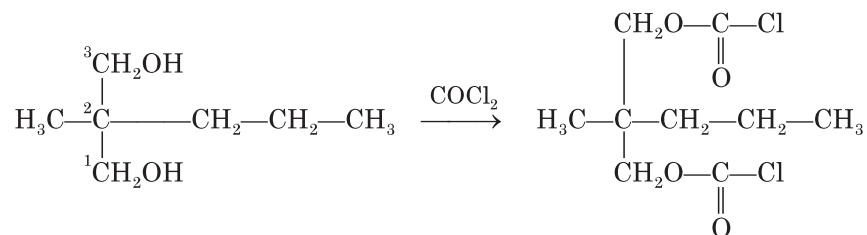

(ii) The chloroformate diester is subjected to ammonolysis to form meprobamate.

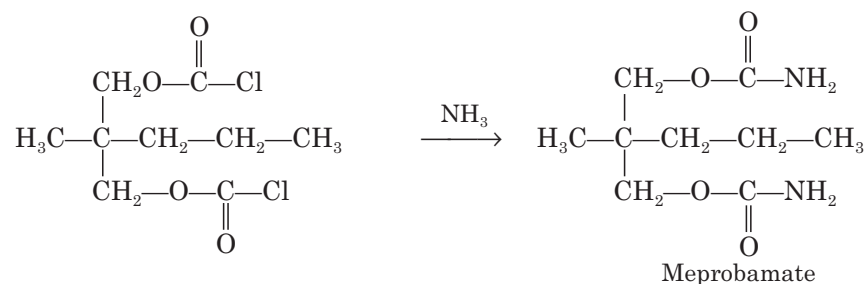

Uses. Meprobamate is used to induce sleep in anxiety and tensive patients. It also possesses anticonvulsant and muscle relaxant properties.

Ethchlorvynol

Ethchlorvynol is 1-chloro-3-ethyl-1-penten-4-yn-3-ol. It is prepared from ethyl chlorovinyl ketone by following chemical reactions under strict anhydrous conditions.

Properties. Ethchlorvynol is a yellow colored liquid with characteristic odor. It is light sensitive drug hence should be protected from light.

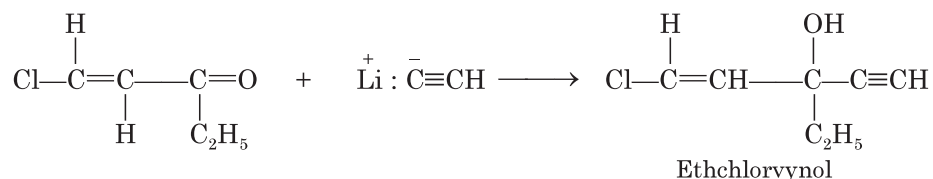

Uses. Ethchlorvynol is a short term hypnotic used to treat insomnia. It has rapid onset, short duration of action and effective for 1–2 weeks.

Flurazepam

Flurazepam is a widely used benzodiazepine derivative to treat all types of insomnia. It is 7-chloro-1-[2-(diethylamino)ethyl]-5-(2-fluorophenyl)-1,3-dihydro-2H-1, 4-benzodiazepin-2-one. Flurazepam is synthesized by condensing benzodiazepinone with 2-chlorotriethylamine.

Properties. Flurazepam occurs as hydrochloride salt. Flurazepam hydrochloride is odorless, water soluble, white or yellow crystalline powder.

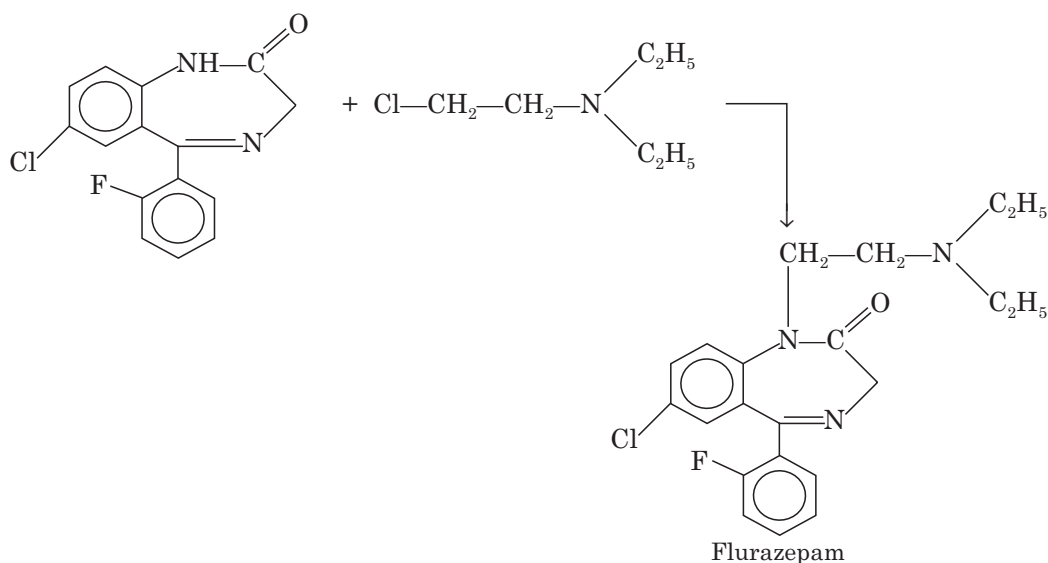

Uses. Flurazepam is a hypnotic or minor tranquilizer that can have long lasting effects of up to 1 month.

Diazepam

Chemistry. Diazepam is 7-chloro-1, 3-dihydro-1-methyl-5-phenyl-2H-1, 4-benzodiazepin-2-one.

Properties. It is white or colorless crystalline, water insoluble powder. It should be stored in a well closed container, protected from light.

Mechanism of Action. Diazepam binds and modifies the GABA receptor chloride ionophore complex in the central nervous system as an agonist, facilitating the physiological effects of GABA (γ -aminobutyric acid) on the GABA receptor complex. Of the α , β , γ and δ subunits of the receptor, α , β subunit determines the function of anxiolysis or sedation, while the γ subunit renders the receptor itself sensitive to benzodiazepines.

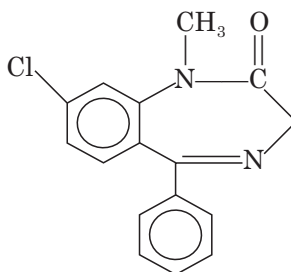

Alprazolam

Chemistry. Alprazolam is a triazolo analogue of 1,4-benzodiazepine. Chemically alprazolam is 8-chloro-1-methyl-6-phenyl-4*H*-s-triazolo [4,3-*a*] [1,4] benzodiazepine.

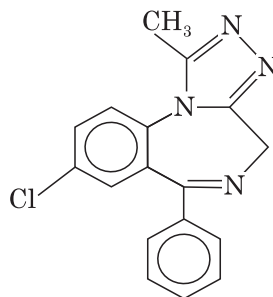

Mechanism of Action. Alprazolam is a short acting benzodiazepine receptor agonist acting at various sites in the CNS. It has been used for short term relief of anxiety and mental depression.

Temazepam

Chemistry. Temazepam is 2*H*-1,4-benzodiazepin-2-one. Chemically temazepam is 7-chloro-1, 3-dihydro-3-hydroxy-1-methyl-5-phenyl-1, 4-benzodiazepin-2-one.

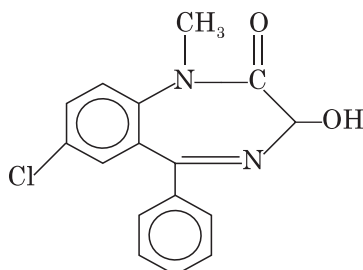

Properties. Temazepam occurs as white crystals melting at 120°C. It is very slightly soluble in water and sparingly soluble in alcohol.

Uses. Temazepam is a hypnotic drug used for the treatment of insomnia. It has long duration of sedative action.

Prazepam

Chemistry. Prazepam is a benzodiazepine derivative. It is a central nervous system depressant. Chemically it is 7-chloro-1-(cyclopropylmethyl)-1,3-dihydro-5-phenyl-2H-1,4-benzodiazepin-2-one. Prazepam differs from diazepam in possessing of cyclopropyl methyl group for 1-methyl group in diazepam.

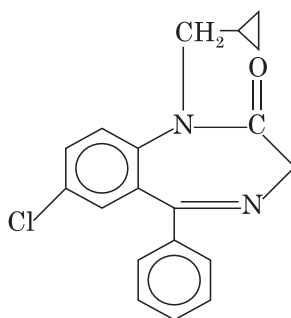

Properties. Prazepam occurs as colorless, crystalline powder. It is practically insoluble in water but soluble in alcohol and chloroform.

Uses. Prazepam is used for symptomatic relief of anxiety.

Chlorazepate

Chemistry. Chlorazepate is a benzodiazepine derivative. It is available as chlorazepate dipotassium.

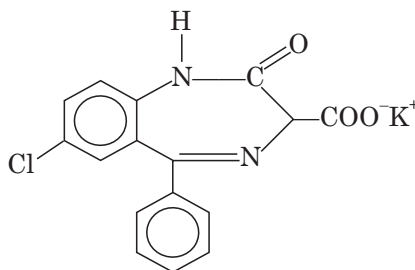

Uses. Chlorazepate is used for symptomatic relief of anxiety associated with neurosis, psychoneurosis.

Triazolam

Chemistry. Triazolam is another widely used benzodiazepine used for short term treatment of insomnia. However serious side effects have caused this drug to be banned in UK and Canada. (anorexia, aggressive behavior, depression). Triazolam is synthesized by condensing a thioamide intermediate possessing benzodiazepine nucleus with acetyl hydrazide.

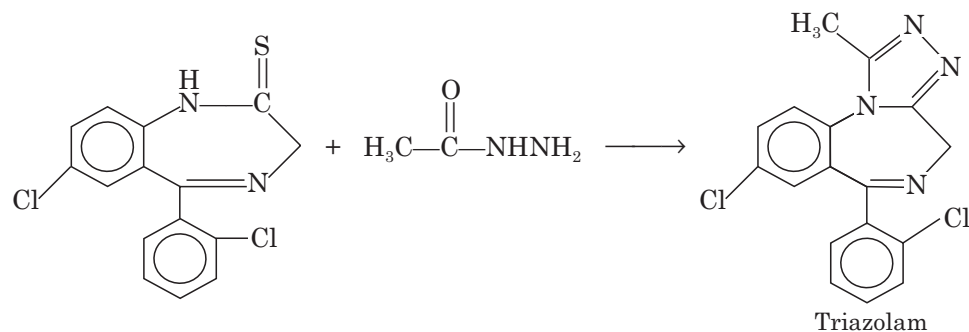

8

Psychoactive Drugs

INTRODUCTION

Psychoactive or psychotropic drugs are also known as tranquilizers. These drugs are used in the treatment of psychiatric disorders i.e. abnormalities of mental function. The psychoactive drugs render the patient calm and peaceful by reducing agitation and anxiety.

Psychoactive drugs does not cure mental disorders but the available drugs do control most symptomatic manifestations and behavioral deviances, facilitate the patient's tendency toward remission and improve the capacity of patient for social, occupational, and familial adjustment. The primary characteristic feature of these drugs is that they alter the mental state and behavior in a predictable way.

CLASSIFICATION OF PSYCHOACTIVE DRUGS

The psychoactive drugs are classified as ;

1. Antipsychotic drugs
2. Anti depressant drugs
3. Anti anxiety drugs

ANTIPSYCHOTIC AGENTS

INTRODUCTION

Anti psychotic drugs are used to treat psychoses like schizophrenia, mania, senile dementia and behaviour disorders in children. These drugs act by depressing the central nervous system (by decreasing dopamine levels) and by producing sedation without producing sleep. Thus the antipsychotics are employed to reduce excitation, agitation, aggressiveness and impulsiveness. Hence they are also known as antischizophrenic drugs or neuroleptic drugs or major tranquilizers.

CLASSIFICATION OF ANTIPSYCHOTIC DRUGS

The drugs used in the treatment of psychoses are classified as follows ;

1. **Phenothiazine derivatives.** Chlorpromazine, prochlorperazine, trifluoperazine, trifluopromazine, promazine.

2. **Butyrophenones.** Haloperidol, droperidol.
3. **Miscellaneous.** Pimozide, molindone.

PHENOTHIAZINES

INTRODUCTION

Phenothiazines act exclusively on specific postsynaptic receptors and block the postsynaptic dopamine receptors. They work on the positive symptoms of psychosis such as hallucinations, delusions, disorganized speech, looseness of association, and bizarre behavior.

Phenothiazines are chemically constituted by a lipophilic, linearly fused tricyclic system having a hydrophilic basic amino alkyl chain. The following is the general structure of antipsychotic drugs.

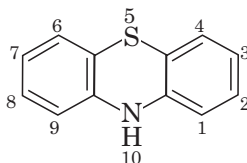

STRUCTURE ACTIVITY RELATIONSHIPS OF PHENOTHIAZINES

Phenothiazines are the derivatives of phenothiazine tricyclic heterocyclic moiety. The central ring possesses nitrogen and sulphur heteroatoms.

1. Substitution at the second position of phenothiazine nucleus by electron withdrawing substituent increases antipsychotic activity.
Ex: Chlorpromazine (chlorine)
2. Substitution at the 3-position of phenothiazine nucleus increases antipsychotic activity than unsubstituted derivatives but not by substitution at 2-position.
3. Substitution at 1 and 4 positions of phenothiazine nucleus reduces the antipsychotic activity.
4. Phenothiazines must have a nitrogen-containing side-chain substituent on the ring nitrogen for antipsychotic activity. The ring and side-chain nitrogens must be separated by a three carbon chain.
5. The side chains are either aliphatic, piperazine, or piperidine derivatives. Piperazine side chains confer the greatest potency and the highest pharmacological selectivity.
6. Fluphenazine and long chain alcohols form stable, highly lipophilic esters, which possess markedly prolonged activity.
7. Substitution on the side chain with a large or polar groups such as phenyl, dimethylamino or hydroxyl results in loss of tranquilizing activity.
8. The phenothiazines produce a lesser degree of central depression than the barbiturates or benzodiazepines.

CHLORPROMAZINE

Chemistry. Chlorpromazine hydrochloride is a phenothiazine derivative and has a chemical formula of 2-chloro-10-[3-(dimethylamino) propyl] phenothiazine monohydrochloride. The molecular formula is $C_{17}H_{19}ClSHCl$. Chlorpromazine is synthesized by cyclization of 3-chlorodiphenylamine with sulphur in presence of small amount of iodine as catalyst.

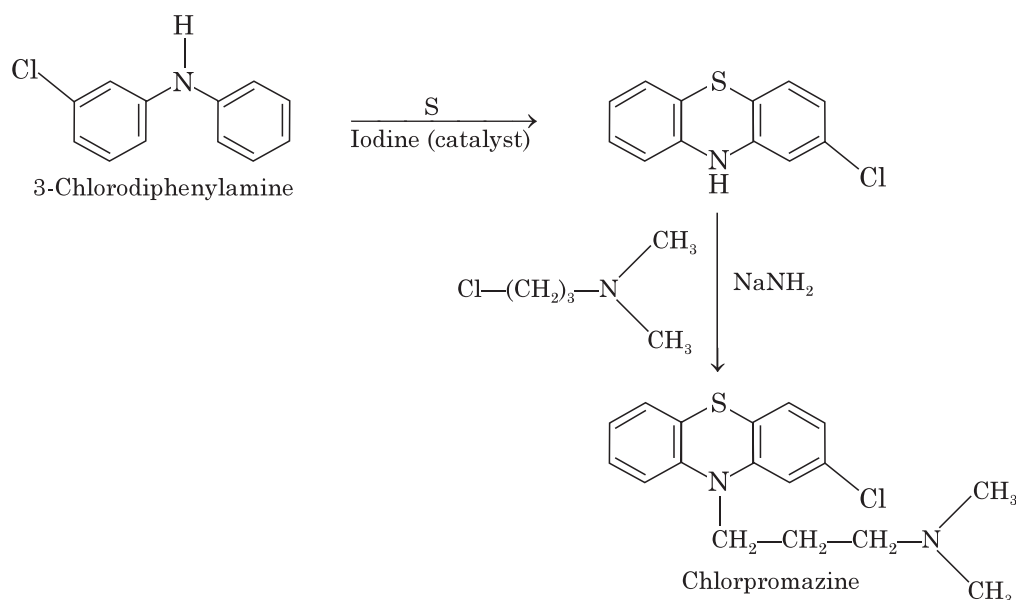

Properties. Chlorpromazine hydrochloride is an odorless, white crystalline powder. It is freely soluble in water, alcohol, chloroform and insoluble in ether and benzene. It decomposes on exposure to air and light hence it should be stored in airtight containers and protect from light.

Mechanism of Action. Exact neural mechanism by which this drug has its anti-psychotic effects is not absolutely determined. Chlorpromazine is thought to block dopamine at D2 receptor sites in the mesolimbic medullary chemoreceptor trigger zone areas of the brain. It causes inhibitory post-synaptic effects by reducing the flow of dopamine as the dopaminergic ion channels are closed.

Uses.

1. Chlorpromazine is used in the management of psychotic conditions. It also controls excitement, aggression and agitation.
2. It has antiemetic, antipruritic, anti-histaminic and sedative properties.

Common side effects.

Extra pyramidal symptoms, hypertension, orthostatic hypotension, blurred vision, dry mouth, anorexia, nausea, vomiting, constipation, diarrhoea, weight gain, impotence, amenorrhoea, photosensitivity.

PROCHLORPERAZINE

Chemistry. Prochlorperazine is a phenothiazine derivative associated with piperazine. Chemically prochlorperazine is 3-chloro-10-[3-(4-methyl-1-piperazinyl) propyl] phenothiazine. It occurs as maleate and mesylate salts.

Prochlorperazine is prepared by refluxing 1-(3-chloro propyl)-4-methylpiperazine with 2-chlorophenothiazine in presence of sodamide in toluene.

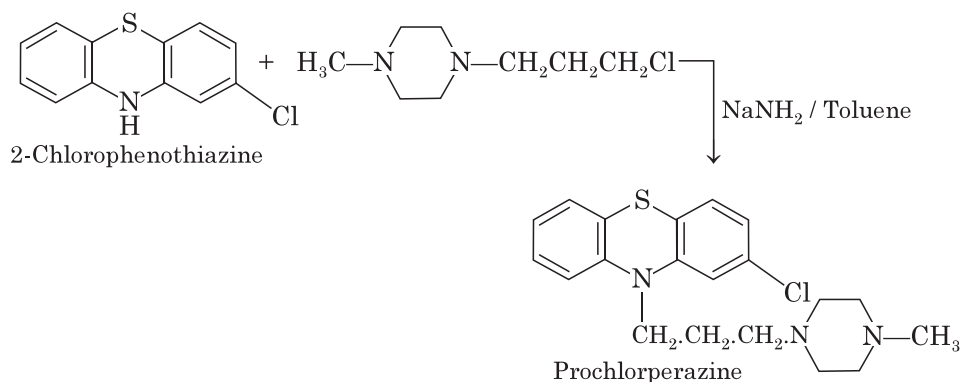

Properties. Prochlorperazine is a pale yellow colored, viscous liquid and is very slightly soluble in water but freely soluble in alcohol.

Uses

1. Prochlorperazine is an antipsychotic and tranquilizing agent. It is used to treat various psychiatric disorders such as schizophrenia, mania, involution psychoses, senile and tonic psychoses.
2. It also has antiemetic properties

TRIFLUOPERAZINE

Chemistry. Trifluoperazine is a fluorinated phenothiazine derivative. It also possesses a piperazine nucleus. Chemically trifluoperazine is 10-[3-(4-methylpiperazin-1-yl)propyl]-2-trifluoromethyl methylphenothiazine. It is prepared by refluxing 2-trifluoromethyl phenothiazine and 3-(4-methylpiperazinyl) propyl chloride in presence of sodamide as a base.

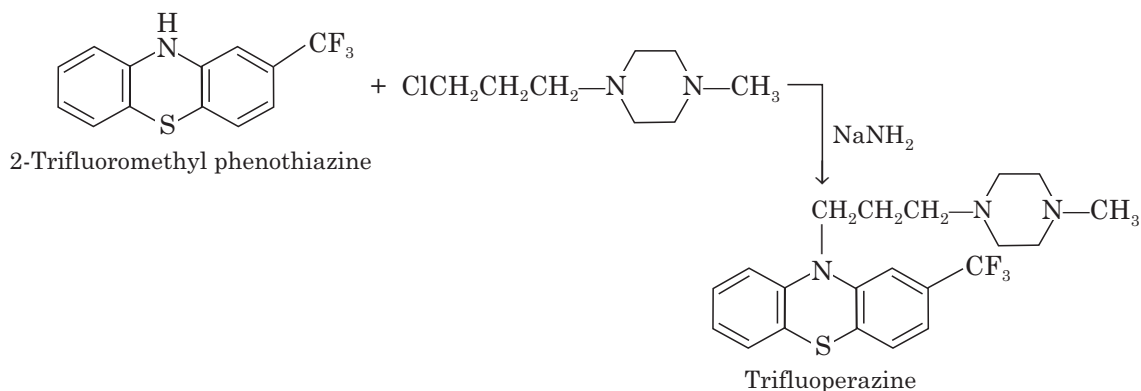

Properties. Trifluoperazine occurs as hydrochloride salt. Trifluoperazine HCl is white to pale yellow, crystalline powder. It is freely soluble in water and should be protected from light and moisture.

Uses. Trifluoperazine has been used to control psychotic disorders. It is effective to control excessive anxiety, tension, aggressiveness and agitation.

TRIFLUPROMAZINE

Chemistry. Triflupromazine is a fluorinated phenothiazine derivative. Chemically triflupromazine is 10-[3-(dimethylamino)propyl]-2-(trifluoromethyl) phenothiazine.

Triflupromazine is synthesized by condensing 2-(trifluoromethyl) phenothiazine with (3-chloropropyl) dimethylamine in dry benzene in presence of sodamide.

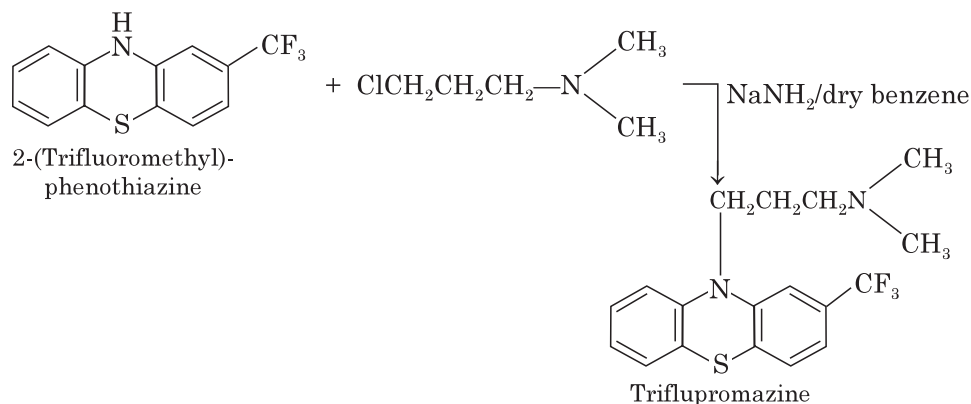

Properties. Triflupromazine occurs as hydrochloride salt. Triflupromazine hydrochloride is white, crystalline powder. It is freely soluble in water, alcohol and insoluble in ether.

Uses.

1. Triflupromazine is used to treat psychotic disorders
2. It also has antiemetic properties

PROMAZINE

Chemistry. Promazine is a phenothiazine derivative. Chemically it is 10-[3-(dimethylamino)propyl] phenothiazine. Promazine is prepared by condensing 3-chloro-N, N-dimethylpropylamine with phenothiazine in presence of sodium hydride.

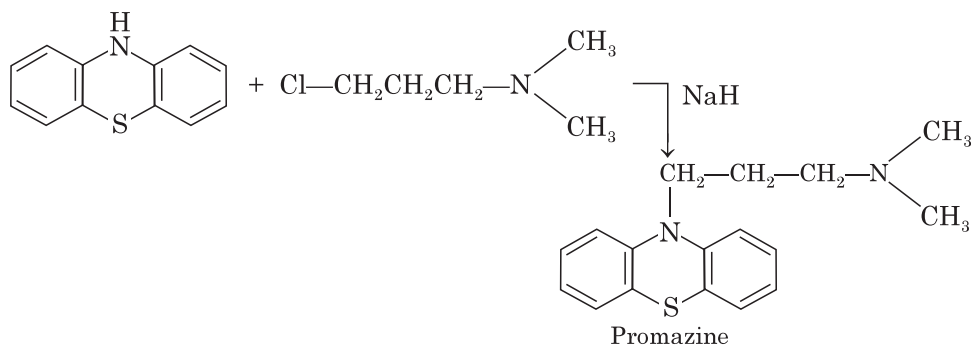

Properties. Promazine is available as hydrochloride salt. Promazine HCl is white or slightly yellow crystalline powder, and is freely soluble in water and chloroform. It should be protected from air.

Uses

1. Promazine has antipsychotic properties
2. It is also used to control nausea and vomiting

BUTYROPHENONES

1. The antipsychotic properties of butyrophenones is due to the presence of the following general structure :

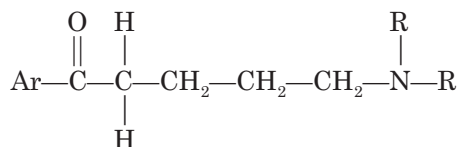

General structure of butyrophenone

2. Intact carbonyl group of butyrophenones is necessary for antipsychotic activity. Replacement of carbonyl group by functional groups such as CH(OH), —CH (X), —O—, —S—, —SO₂— etc., decreases activity.
3. All butyrophenones must have a fluorine atom in para-position of aryl group. The antipsychotic activity is markedly decreased by introducing H, Cl, CH₃, OCH₃ or Ar instead of fluorine at para position in aryl group.
4. Propylene bridge is required for antipsychotic properties. Shortening or lengthening or branching of propylene bridge decreases antipsychotic activity.
5. Incorporation of basic nitrogen into 6-membered rings is important for CNS depressant activity.

Ex: Haloperidol

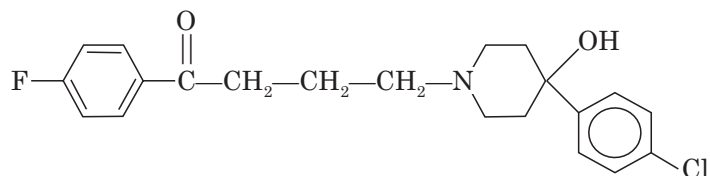

Droperidol

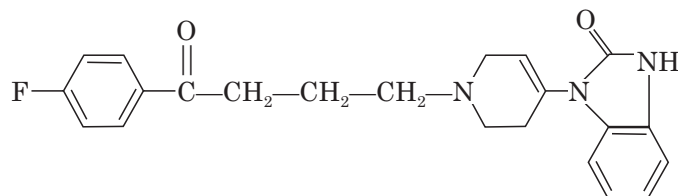

HALOPERIDOL

Chemistry. Haloperidol is a butyrophenone derivative with antipsychotic properties that has also been found as effective in lowering levels of hyperactivity, agitation, and mania. It has chemical formula of 4-[4-(*p*-chlorophenyl)-4-hydroxypiperidino]-4'-fluorobutyrophenone. Haloperidol is synthesized by condensing 4-(4-chlorophenyl-4-piperidino] with 4-chloro-4'-fluorobutyrophenone:

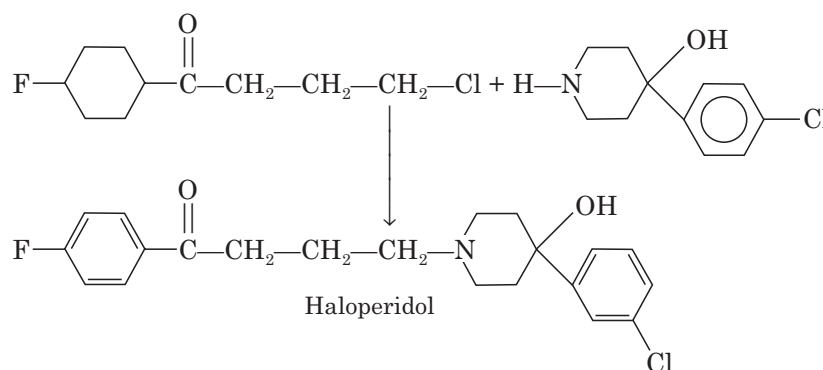

Mechanism of action. The mechanism of action of haloperidol has not been entirely elucidated, but has been attributed to the inhibition of the transport mechanism of cerebral monoamines, particularly by blocking the impulse transmission in dopaminergic neurons. Peak plasma levels of haloperidol reaches within 2 to 6 hours of oral administration.

Uses.

1. Haloperidol is effective in the management of hyperactivity, agitation, and mania.
2. Haloperidol is an effective neuroleptic and also possesses antiemetic properties ; it has a marked tendency to provoke extrapyramidal effects and has relatively weak alpha-adrenolytic properties.
3. It may also exhibit hypothermic and anorexiatic effects and potentiates the action of barbiturates, general anesthetics, and other CNS depressant drugs.

ANTI-ANXIETY AGENTS (ANXIOLYTICS)

INTRODUCTION

Anxiety is a multisystem response to a perceived threat or danger. It reflects a combination of biochemical changes in the body, the patient's personal history and memory, and the social situation. It is important to distinguish between anxiety as a feeling or experience, and an anxiety disorder as a psychiatric diagnosis. A person may feel anxious without having an anxiety disorder.

Antianxiety drugs are medicines that calm and relax people with excessive anxiety, nervousness, or tension, or for short-term control of social phobia disorder or specific phobia disorder. They may be used to treat mild transient bouts of anxiety as well as more pronounced episodes of social phobia and specific phobia. They are some times called as 'minor tranquilizers'. A wide range of antianxiety drugs are available and are classified as :

- (i) **Benzodiazepines** : Ex: Lorazepam, diazepam
- (ii) **Barbiturates** : Ex: Phenobarbitone, secobarbital
- (iii) **Non-barbiturate sedatives** : Ex: Chloral hydrate, meprobamate

Benzodiazepines

Benzodiazepines are the most commonly used anxiolytics and hypnotics. They act at benzodiazepine receptors, which are associated with gamma-aminobutyric acid (GABA) receptors. Clinically useful benzodiazepines to treat anxiety are diazepam, chlordiazepoxide, oxazepam, prazepam, alprazolam, lorazepam, chlorazepate.

Mechanism of Action

These drugs are not fully understood in their actions. The benzodiazepine receptor was announced in 1977. Today it is recognized that there are at least three distinct binding sites for the benzodiazepines. Furthermore, these receptors are not isolated, but rather are parts of a *macromolecular complex* that includes (1) the GABA-A receptor (2) the benzodiazepine receptor, (3) the binding site for the barbiturates. Benzodiazepines modulate the activity of gamma-aminobutyric acid (GABA) in the brain and may be responsible for the inhibitory effect. Anxiolytics potentiate a major inhibitory neurotransmitter called gamma-aminobutyric acid (GABA). This causes a reduction in the excitability of the central nervous system.

When the inhibitory neurotransmitter gamma-aminobutyric acid (GABA) binds to its binding site, the result is that the chloride channel opens and allows Cl^- ions in, hyperpolarizing the cell and making it less excitable. Now, the benzodiazepine site, when bound, allosterically alters the shape of the GABA site so that it fits GABA better, it has a greater *affinity* for the GABA molecule.

Structure-Activity Relationships of benzodiazepines

- There are several benzodiazepines. The benzodiazepines produce a wide range of effects, and are used for all sorts of things. In medicine, they are usually used for anxiety and insomnia, though they are occasionally used in musculoskeletal injuries, alcohol detoxification, Three of their effects are considered hallmarks (1) anti-convulsant effect, (2) muscle relaxant effect and (3) anti-anxiety effect.

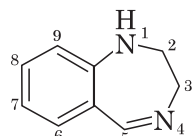

1,4-Benzodiazepine

- Almost all active benzodiazepines, except those possessing a fused heterocyclic ring or a thionyl group, have a carbonyl group at position 2.

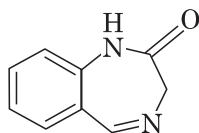

1,4-Benzodiazepin-2-one

3. A benzene ring, separated from the *heterocyclic* benzodiazepine ring system by a single bond. A benzene ring is called a *phenyl* group when it is part of a larger molecule. There *must* be an electron withdrawing substituent at position 7. The halogens : chlorine, fluorine, bromine, and iodine are nice attractors of electrons.

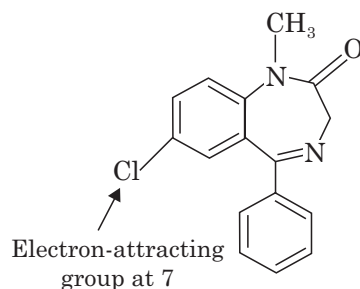

N-methyl-7-chloro-5-phenyl-1, 4-benzodiazepin-2-one
(diazepam)

4. Addition of *methyl group* to the nitrogen at position 1, yields a prototype benzodiazepine diazepam. This drug exhibits all three of the basic benzodiazepine effects (1) skeletal muscle relaxation (2) anticonvulsant activity and (3) antianxiety effects at doses far lower than those that cause *ataxia* (loss of balance).
5. The first benzodiazepine, chlordiazepoxide, is a 2-amino benzodiazepine. This compound quickly metabolizes into several benzodiazepin-2-ones, and is more potent. Eventually, triazolobenzodiazepines (alprazolam and triazolam) were found to be much more potent. The triazolo compounds do not require any substitution at position 7.
6. Positions 6, 8, and 9 should be left unsubstituted.
7. The presence of a phenyl at the 5-position increases activity, and all benzodiazepines have this substituent. 5-Phenyl ring with electron-attracting (generally halogen atoms) groups at the 2' position show greatly increased activity, and produce greater amnesia (lorazepam, and compare alprazolam and triazolam) while 4' (*para*) substitution decreases or abolishes activity.
8. The 4,5 double bond should not be moved or saturated.
9. The N-substituent at position 1 should be small for higher intrinsic activity; however, drugs with large substituents at this position have been prepared and marketed (e.g., flurazepam, prazepam, halazepam, not shown). They owe their activity to metabolic dealkylation, often to nordazepam.

Lorazepam. Lorazepam is 7-chloro-5-(2-chlorophenyl)-1,3-dihydro-3-hydroxy-1,4-benzodiazepin-2-one.

Properties. It occurs as white, crystalline, water-insoluble powder.

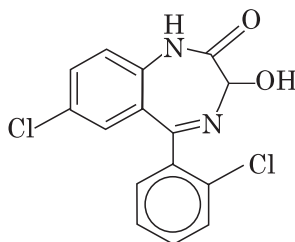

Following is an outline of the synthesis of lorazepam.

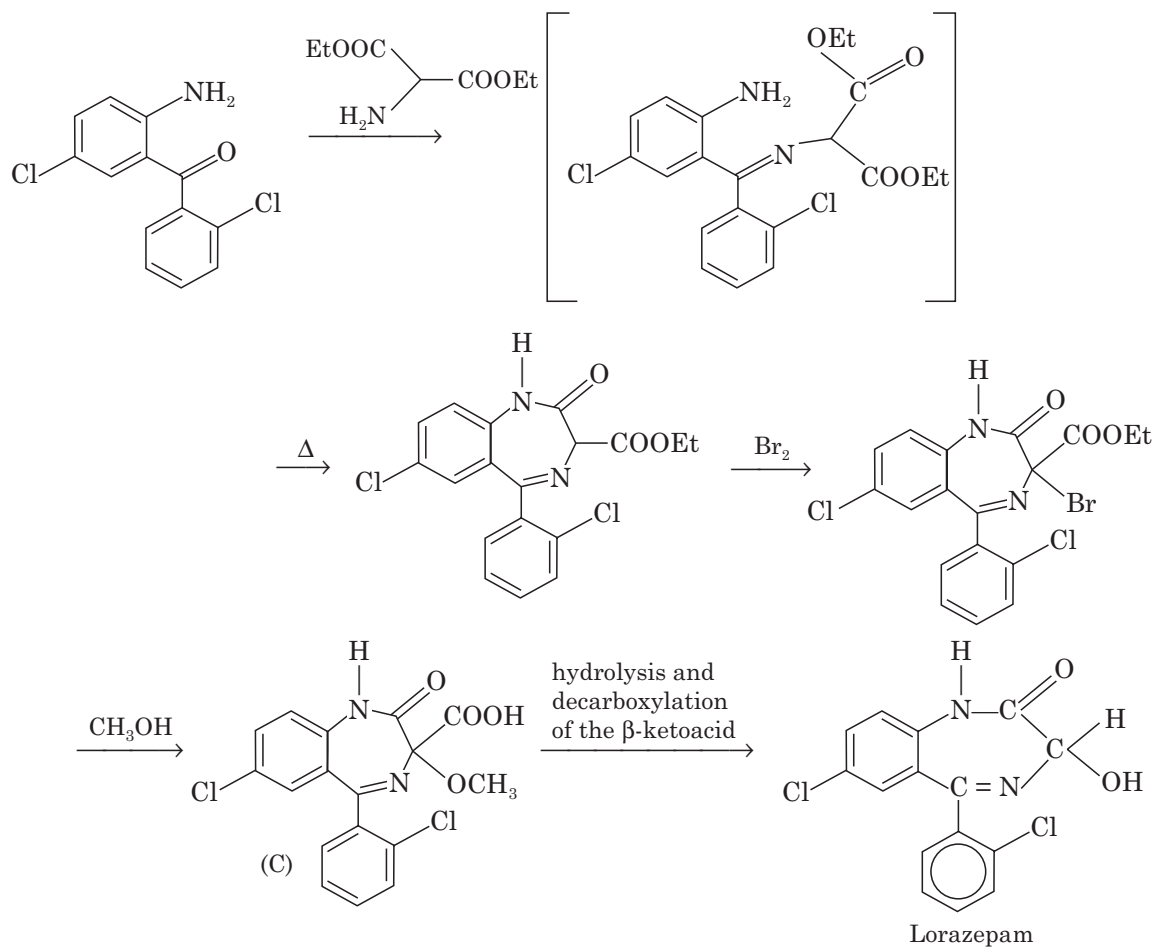

DIAZEPAM

Chemistry. Diazepam is a benzodiazepine derivative. Chemically it is 7-chloro-1,3-dihydro-1-methyl-5-phenyl-2H-1,4-benzodiazepin-2-one

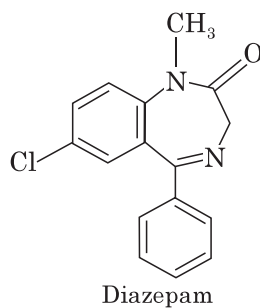

Properties. A white or almost white, crystalline powder, very slightly soluble in water, soluble in alcohol.

Synthesis

Step 1. The amine nitrogen of 4-chloro-N-methylaniline is first protected by treatment with acetic anhydride.

Step 2. Friedel-Craft's acylation is directed by the amide nitrogen, which is activating and ortho, para directing. Chlorine is also ortho, para directing but it is deactivating and, therefore, the amide nitrogen takes precedence in directing the position of further electrophilic aromatic substitution.

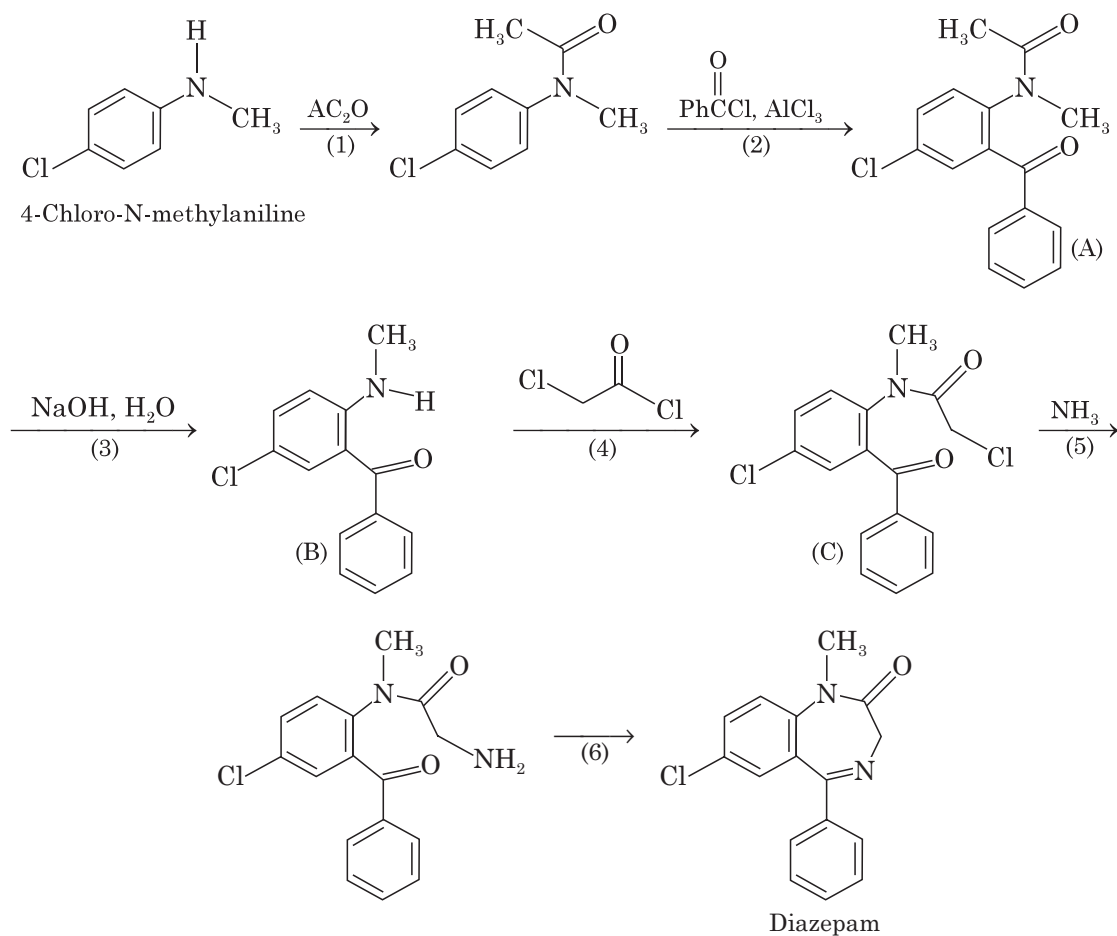

Step 3. The acetyl-protecting group of A is removed by treatment with aqueous NaOH to give (B).

Step 4. Treatment of the amino group of (B) with chloroacetyl chloride results in acylation to form (C).

Step 5. Treatment of (C) with ammonia results in nucleophilic displacement of chlorine by an S_N^2 reaction to form a primary amine.

Step 6. Intramolecular reaction of the ketone and 1° amine groups results in formation of an imine (a schiff base) and completes the synthesis of diazepam.

Clinical uses. Diazepam is the drug of first choice for the treatment of status epilepticus (a particular type of convulsive disorder) when it is given intravenously.

Uses of benzodiazepines.

1. Benzodiazepines are indicated for the short-term relief (two to four weeks only) of anxiety that is severe, disabling or subjecting the individual to unacceptable distress, occurring alone or in association with insomnia or short-term psychosomatic, organic or psychotic illness.
2. The use of benzodiazepines to treat short-term mild anxiety is inappropriate and unsuitable.

Common side effects of benzodiazepines:

Mental slowing, sedation, blurred speech, blurred vision, anorexia, nausea, vomiting, dry mouth, diarrhoea, and constipation.

Newer Benzodiazepines. The following are some newer benzodiazepines :

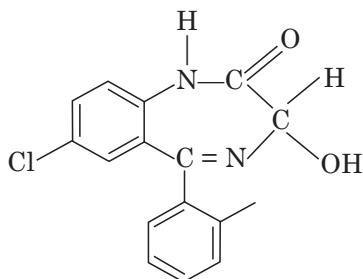

Oxazepam

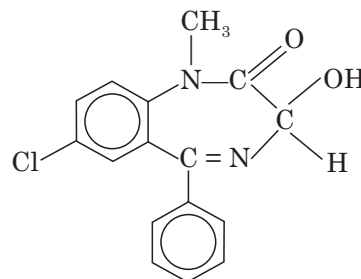

Temazepam

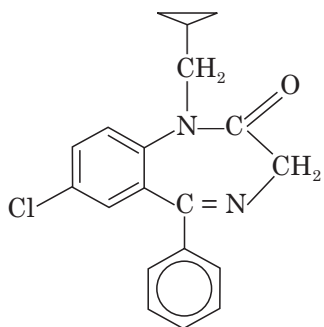

Prazepam

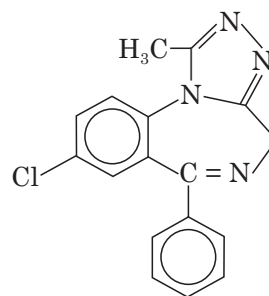

Alprazolam

ANTIDEPRESSANT AGENTS

INTRODUCTION

Sadness, helplessness, inferiority, despair, worthlessness, crying, guilt, suicidal tendencies, and episodic frequency characterize depression. Major depression is one of the most common

psychiatric disorders affecting humankind. It has been estimated that 7 to 12% of men and 20 to 25% of women will experience a major depressive episode in their lifetime. Major depression is believed to arise from disturbances in brain neurotransmitter systems.

Antidepressants are a class of psychotherapeutic drugs that are used to treat major depression. The therapeutic effect of antidepressants aims at the restoration of mood and behavior. They are also effective for dysthymia (lower grade chronic depression). Antidepressant drugs are not generally effective in milder forms of acute depression but a trial may be considered in cases refractory to psychological treatments.

HISTORY OF ANTIDEPRESSANTS

Most antidepressant drugs were discovered by serendipity. Iproniazid, the first modern antidepressant, was originally developed as an antitubercular drug in the early 1950's. In addition to its ability to treat tuberculosis, iproniazid was observed to elevate mood and stimulate activity in many patients.

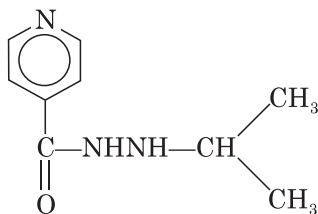

Structure of iproniazid

These effects led researchers to investigate the ability of iproniazid to treat the symptoms of depression. After promising preliminary findings reported in 1957, iproniazid was prescribed widely to patients with major depression. Within the first year it was available as an antidepressant, four hundred thousand depressed people were treated with iproniazid. Subsequent studies demonstrated the ability of this drug to block the activity of monoamine oxidase, the enzyme that destroys the monoamine neurotransmitters (norepinephrine, serotonin and dopamine). Although iproniazid is no longer used as an antidepressant because of toxic side-effects, the effectiveness of this drug led to further interest in the idea that depression might be alleviated by appropriate drugs.

The first tricyclic antidepressant, imipramine, was originally developed in a search for drugs useful in the treatment of schizophrenia. Although clinical trials demonstrated lack of effect in treating schizophrenia. Early studies in 1957 and 1958 reported that imipramine significantly alleviated symptoms in patients with major depression. Interestingly, although imipramine elevated mood and increased energy in depressed patients, the drug proved to be sedating in individuals without major depression. These effects led to the idea that imipramine was selectively reversing the depression, rather than simply producing a general activating effect. Subsequent biochemical studies on imipramine demonstrated that this drug increased the activity of the monoamine neurotransmitters, norepinephrine and serotonin, by inhibiting their reuptake into neurons.

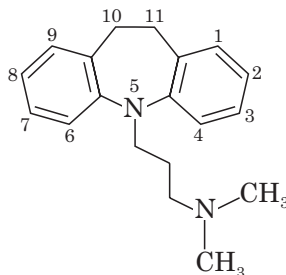

Imipramine

The monoamine oxidase inhibitors (MAOIs) and tricyclic antidepressants (TCAs), although having different modes of action, their primary effect is to increase the activity of monoamines in the brain. This observation, together with other findings, led to monoamine theory of depression—the idea that depression arises from a deficit in norepinephrine and/or serotonin activity, and that antidepressants work by normalizing this deficit. This theory led to the development of the next major class of antidepressants, the selective serotonin reuptake inhibitors (SSRIs). In order to develop an antidepressant that worked effectively on the symptoms of depression, but that did not have the side effects of the MAOIs or the tricyclics, a systematic search was begun for drugs that selectively enhance activity of one monoamine, but not others. The first SSRI, fluoxetine was released in 1987. This drug and other SSRIs, as the name implies, selectively inhibit the reuptake of serotonin, and thereby increase serotonin activity in the brain.

CLASSIFICATION

Compounds that exhibit antidepressant activity are called thymoleptics. The major types of drugs included in this class are the monoamine oxidase inhibitors, tricyclic antidepressants, selective serotonin reuptake inhibitors and atypical antidepressants. Either tricyclic and related antidepressants or SSRIs are generally preferred because MAOIs may be less effective and show dangerous interactions with some food and drugs.

<i>Generic Name</i>	<i>Usual Dosage in mg.</i>	<i>Half Life (hours)</i>
TCAs		
Amitryptaline	50—300	31—46
Protryptiline		
Imipramine		
Trimipramine		
Desipramine	50 —300	12—24
MAOIs		
Phenelzine	30—90	1.5—4

Isocarboxazid	30—50	—
Tranyl cypromine	20—60	1.5—3.2
SSRIs		
Fluoxetine	1—100	2—5 days
Fluvoxamine	25—300	4—6 days
Paroxetine	10—50	5—21
Sertraline	12.5—200	24
Citalopram	10—60	23—45
Miscellaneous		
Trazodone	50—400	4—9
Venlafaxine	25—375	3—7
Bupropion	200—300	8 days
Nefazodone	100—600	2—5

TRICYCLIC ANTIDEPRESSANTS

Tricyclic antidepressants inhibit the reuptake of the neurotransmitters, serotonin and norepinephrine into their respective nerve terminals. Reuptake is the first step in the process

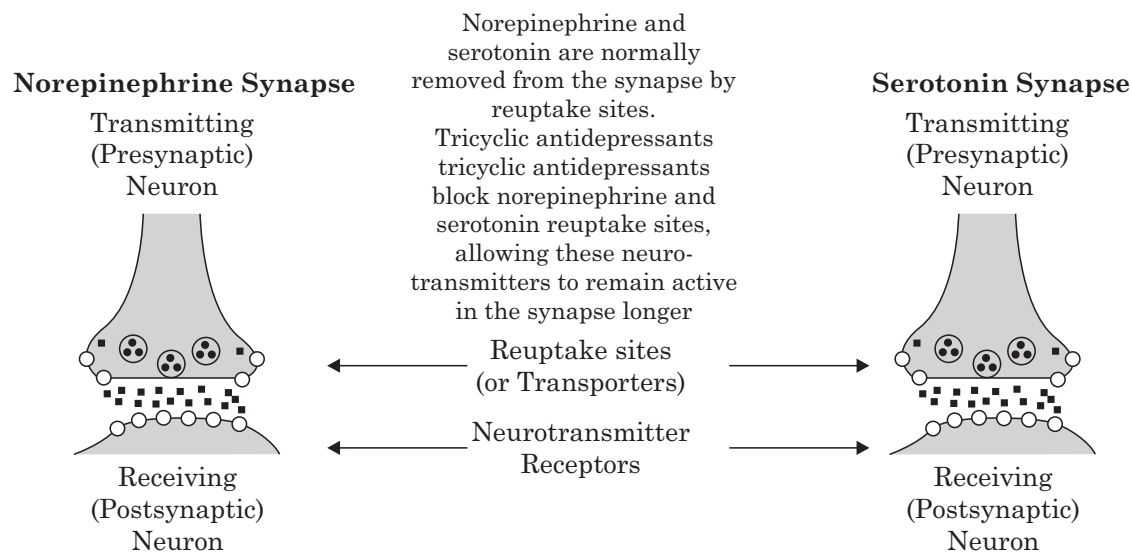

of deactivating these neurotransmitters in the brain. After serotonin and norepinephrine are released from neurons, they are removed from the extracellular space by transporters (also

known as reuptake sites) located on the cell membrane. These compounds block the reuptake of monoamines, thereby elevating levels of noradrenaline and 5-HT. By inhibiting reuptake, the drugs allow serotonin and norepinephrine to remain active in the synapse longer, thereby correcting a presumed deficit in the activity of these neurotransmitters.

Chemistry of Tricyclic Antidepressants

1. The name tricyclic is a little misleading, referring to the three ring chemical structure but many of the drugs included in this class may actually contain anywhere from one to four rings.
2. Because they are similar in structure to the neuroleptics (with three rings), there are instances of overlapping activities. Note the differences in structure of the central ring. In general, the tricyclic antidepressants are mood-elevating drugs. Imipramine and amitriptyline are examples of tricyclic antidepressants.

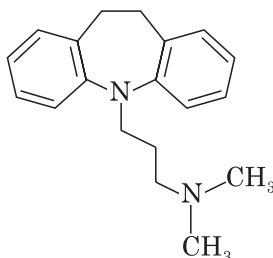

Imipramine

3. The activity of the tricyclic drugs depends on the central ring of seven or eight atoms, which confers an angled or twisted conformation. The side chain must have at least 2 carbons although 3 appear to be better. The amine group may be either tertiary or secondary.
4. Tricyclic Antidepressants have a characteristic ring structure compared to phenothiazines.

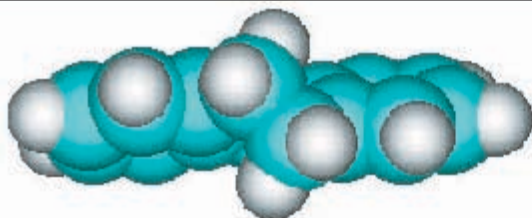

10, 11-Dihydrocycloheptene

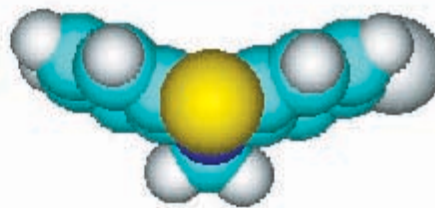

5, 10-Phenothiazine

5. All tricyclic antidepressants block the reuptake of norepinephrine at nerve terminals. However, the potency and selectivity for the inhibition of the uptake of norepinephrine, serotonin, and dopamine vary greatly among the agents. The tertiary amine tricyclics seem to inhibit the serotonin uptake pump, whereas the secondary amine ones seem better in switching off the norepinephrine pump.

Chlorimipramine

Chlorimipramine is 3-chloro-5-(3-dimethylaminopropyl)-10,11-dihydro-5H-dibenzo-[*b, f*]-azepine. Chlorimipramine blocks the reuptake of 5-HT better than any of the other tricyclic antidepressants. Chlorimipramine selectively blocks the reuptake of serotonin, thereby increasing the levels of serotonin in the central nervous system. It is useful in the treatment of obsessive-compulsive disorders.

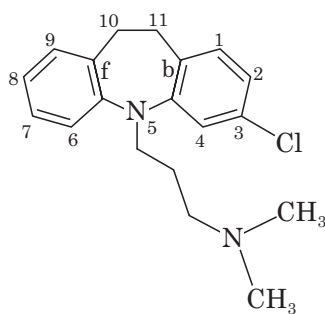

Chlorimipramine

Amitriptyline

Amitriptyline is 5-(3-dimethylaminopropylidene)-5H-[*a, d*]-dibenzo-10,11-dihydro-cycloheptene. However, it is more potent in blocking the reuptake of norepinephrine (NE) than 5-HT and much less potent in blocking the reuptake of dopamine. It causes high sedation and high weight gain.

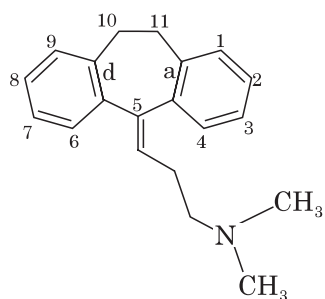

Amitriptyline

In synthesis of amitriptyline, the ketone (A) is treated with the Grignard reagent formed from 3-dimethylaminopropyl bromide to give a tertiary alcohol. Acid-catalyzed dehydration of the alcohol gives amitriptyline.

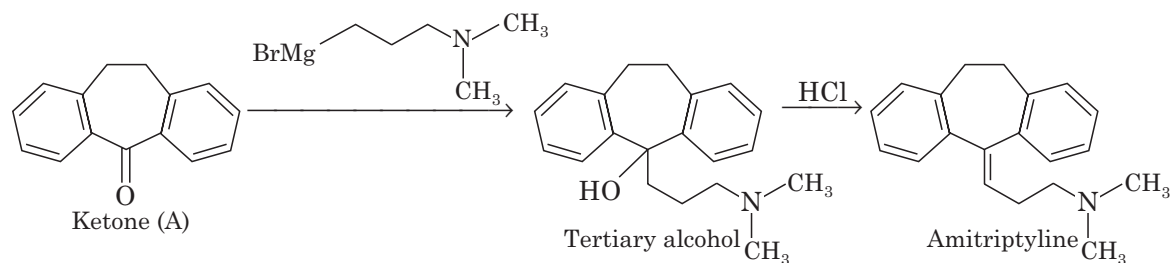

Imipramine

Imipramine is the parent tricyclic antidepressant. Imipramine is 5-(3-dimethylamino-propyl)-10, 11-dihydro-5H- dibenz-[*b*, *f*]-azepine. It has weak D2 postsynaptic blocking, anticholinergic and sedative activities.

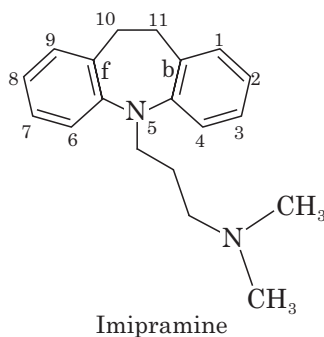

Desipramine

Desipramine is 5-(3-methylaminopropyl)-10, 11-dihydro-5H-dibenz-[*b*, *f*]-azepine. Imipramine metabolism to desipramine is fast and desipramine levels are higher than imipramine. It causes low sedation, low weight gain.

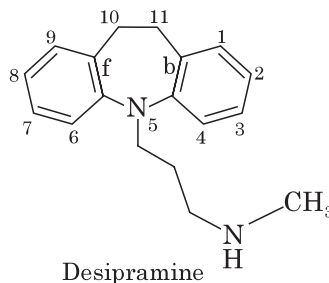

Nortriptyline

Nortriptyline is 5-(3-methylaminopropylidene)-10,11-dihydro-5H-dibenzo-[*a*,*d*]-cycloheptene. Secondary amines have much greater selectivity for blockade of reuptake of norepinephrine (NE) compared to 5-HT.

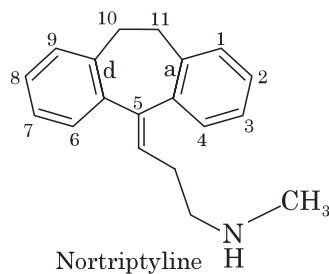

Clozapine

This tricyclic dibenzodiazepine derivative has a chemical formula of 8-chloro-11-(4-methyl-1-piperazinyl)-5H-dibenzo [b, e] [1, 4] diazepine. Clozapine is administered orally. It interferes with the binding of dopamine molecules at the D1, D2, D3, D4, and D5 dopamine receptors.

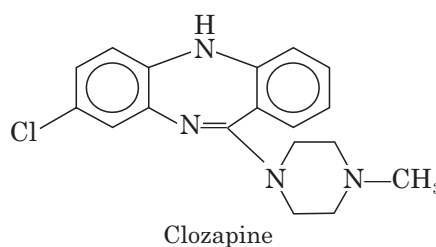

Uses of tricyclic antidepressants

1. Tricyclic antidepressants elevate mood, increase physical activity, normalize appetite and sleep patterns, and reduce morbid preoccupation in 60%–70% of patients with major depression.
2. Like the other classes of antidepressants, therapeutic effects of the tricyclics may take from two to six weeks to appear. Often, the first symptom to subside is insomnia, followed a few days later by an increase in activity and an improvement in concentration and memory.

SELECTIVE SEROTONIN REUPTAKE INHIBITORS

Selective serotonin reuptake inhibitors (SSRIs) represent a relatively new class of antidepressant drugs. These drugs are referred to as “clean” drugs because they primarily affect only serotonin (in contrast to MAOIs and tricyclics which affect other monoamines). Because SSRIs are more targeted, they have a lower incidence of some of the side effects associated with tricyclic antidepressants and MAOIs (e.g., blurred vision, dizziness, constipation, dry mouth).

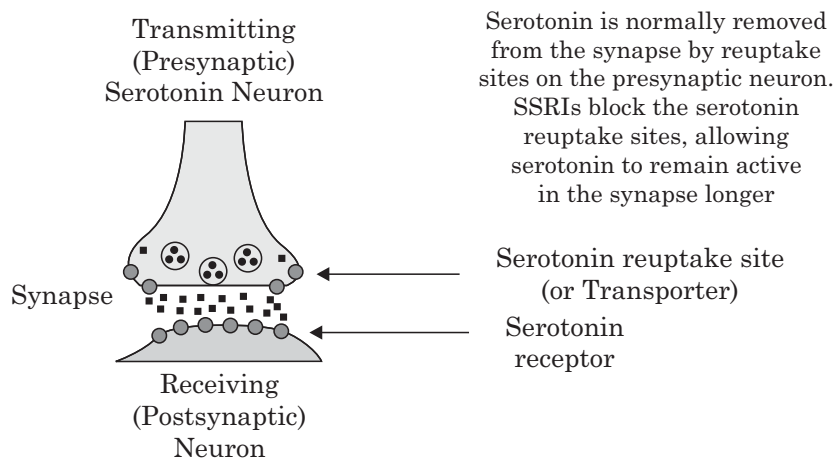

The SSRIs, inhibit reuptake of serotonin. Reuptake is the first step in the process of deactivating this neurotransmitter in the brain. After serotonin is released from neurons, it is removed from the extracellular space by transporters, or reuptake sites, located on the cell membrane. SSRIs block serotonin reuptake sites, allowing serotonin to remain active in the synapse longer, thereby correcting a presumed deficit in the activity of this neurotransmitter.

Fluoxetine

Fluoxetine is the most widely used drug in this class. It is N-methyl-3-phenyl-3-(*p*-trifluoromethyl)-phenoxy-propylamine. It is a potent selective inhibitor of 5-HT reuptake.

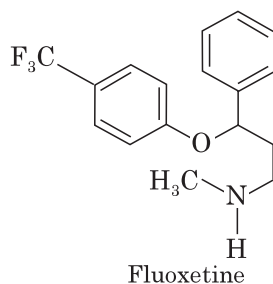

Synthesis. Following is an outline for the synthesis of fluoxetine

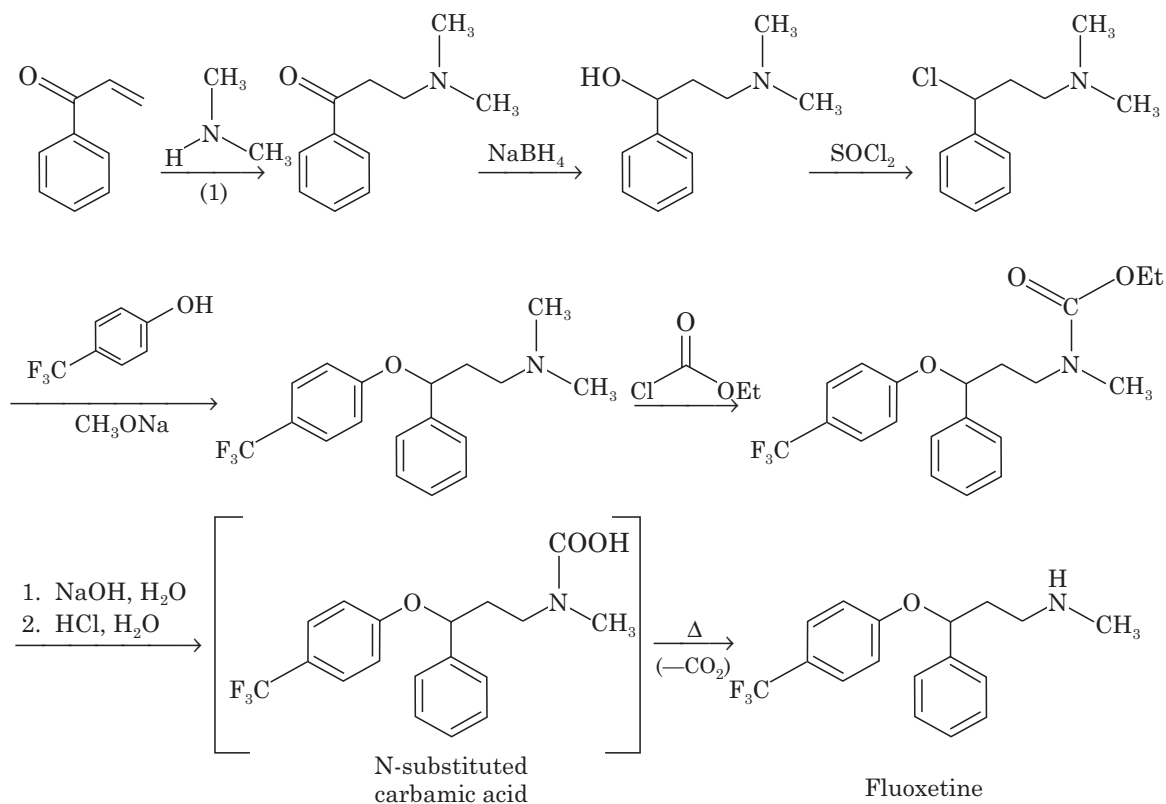

Paroxetine

Paroxetine is (-)-trans-4-(*p*-fluorophenyl)-3-((3,4-(methylenedioxy)phenoxy)methyl) piperidine. It is also a potent selective inhibitor of 5-HT reuptake.

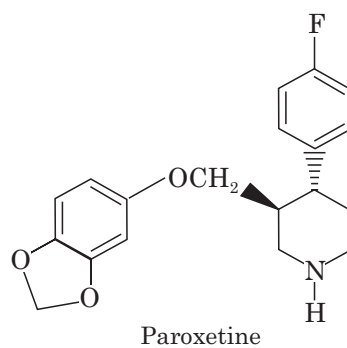
**Fluvoxamine**

Fluvoxamine has the shortest half-life of all the SSRIs. Sedation is more common with fluvoxamine than with other SSRIs. Anorexia and weight loss is less of a concern with fluvoxamine than with fluoxetine.

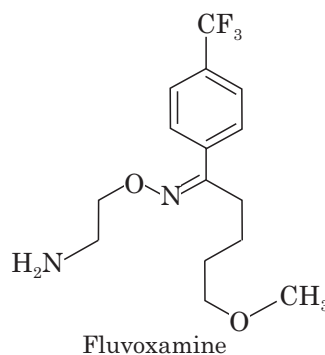
**Zimelidine**

Zimelidine is (*Z*)-3-[1(*p*-bromophenyl)-3-(dimethylamino)propenyl]pyridine. It is a potent selective inhibitor of 5-HT reuptake.

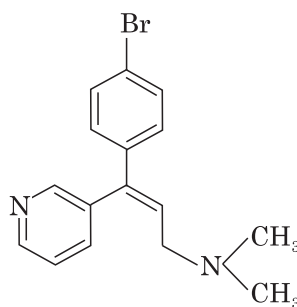

Sertraline

Sertraline is (1*S*, 4*S*)-4-(3,4-dichlorophenyl)-1, 2, 3, 4-tetrahydro-*N*-methyl-1-naphthylamine. It is a potent selective inhibitor of 5-HT reuptake.

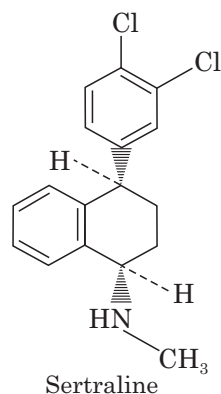

Venlafaxine

Venlafaxine is *N,N*-dimethyl-2-cyclohexanol-3-(*p*-methoxyphenylpropylamine). It is potent inhibitor of 5-HT and norepinephrine reuptake.

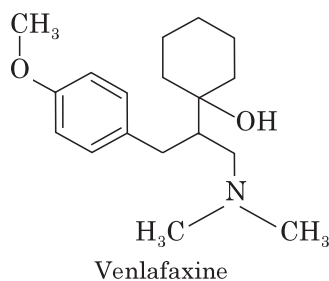

Uses of selective serotonin re-uptake inhibitors

In recent years, selective serotonin reuptake inhibitors have been introduced for the treatment of depression.

ATYPICAL ANTIDEPRESSANTS

Atypical antidepressants are the newer classification of neuroleptics. The conventional and atypical antidepressants work equally well at treating the positive symptoms of schizophrenia. But the conventional neuroleptics have minimal effects on the negative symptoms, the atypical drugs work well to treat this cluster of symptoms. The neurological effects are a result of antagonism at D2 receptors. There are side effects (tardive dyskinesia) which appears mostly with chronic administration of the conventional antipsychotics. Ex: Venlafaxine, Trazodone, Nefazodone, Fluoxetine

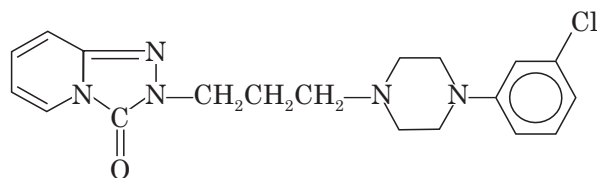

Trazodone

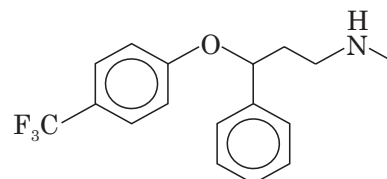

Fluoxetine

MONOAMINE-OXIDASE INHIBITORS

INTRODUCTION

Monoamine oxidase inhibitors (MAOIs), inhibit the activity of monoamine oxidase (MAO), enzyme. Monoamine oxidase (MAO) causes the oxidative deamination of norepinephrine, serotonin, and other amines thus destroys monoamine neurotransmitters (norepinephrine, dopamine or serotonin) in synapses. This oxidation is the method of reducing the concentration of the neurotransmitter after it has sent the signal at the receptor site. Normally, neurotransmitters carry signals from one brain cell to another. Some neurotransmitters, such as serotonin and norepinephrine, play important role in controlling mood. But other substances in the brain may interfere with mood control by breaking down these neurotransmitters. MAO inhibitors work by blocking the chemicals that break down serotonin and norepinephrine. The inhibition of this enzyme allows these neurotransmitters to remain active in the brain longer, which in turn causes a stimulation effect, thereby correcting a presumed deficit in monoamine function.

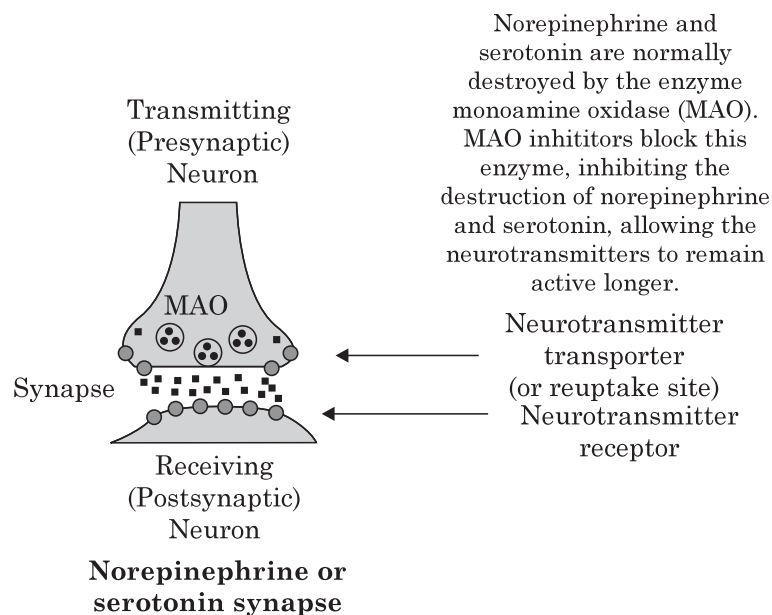

These drugs are less effective and produce more side effects than the tricyclic antidepressants. For example, they lower blood pressure and were at one time used to treat hyper-

tension. Their use in psychiatry has also become very limited, as the tricyclic antidepressants have come to dominate the treatment of depression and allied conditions. Thus, MAOIs are used most often when tricyclic antidepressants give unsatisfactory results.

Most MAO inhibitors are hydrazine derivatives. Hydrazine is highly reactive and may form a strong covalent bond with MAO with consequent inhibition for up to 5 days. Some commonly used MAO inhibitors are isocarboxazid, phenelzine, and tranylcypromine.

Phenelzine

Phenelzine is 2-phenylethyl hydrazine. It is the hydrazine analog of phenylethylamine, a substrate of MAO. Phenelzine and several other MAOIs, such as isocarboxazid, are structurally related to amphetamine and were synthesized in an attempt to enhance central stimulant properties.

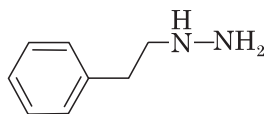

Phenelzine

Selegiline

Selegiline is (R)-(-)-N, α -dimethyl-N-2-propynyl-phenethylamine. It is selective MAO inhibitor. Requires up to 2-4 weeks for therapeutic response.

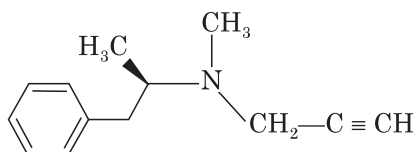

Selegiline

Tranylcypromine

Tranylcypromine is (\pm)-*trans*-2-phenylcyclopropylamine. It is Non-selective, reversible MAO inhibitor. Generally, tranylcypromine has a more rapid onset than other MAO inhibitors. Cis isomer is less active.

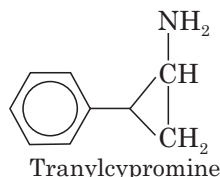

Tranylcypromine

Uses of monoamine-oxidase inhibitors

MAOIs are antidepressants, which are efficacious in the treatment of atypical depression (vegetative symptoms, anxiety, initial insomnia), panic disorder, anxiety and recently discovered borderline personality disorder.

MAO inhibitors are a type of antidepressant and are used to treat mental depression. Like other antidepressant drugs, MAO inhibitors help to reduce the extreme sadness, hopelessness, and lack of interest in life that are typical in people with depression.

MAO inhibitors are especially useful in treating people whose depression is combined with other problems such as anxiety, panic attacks, phobias, or the desire to sleep too much.

Side Effects of Monoamineoxidase Inhibitors

MAO inhibitors also affect other chemicals throughout the body, these drugs may produce many unwanted side effects.

They can be especially dangerous when taken with certain foods, beverages and medicines. MAO inhibitors produce harmful side effects known as the “cheese effect” (The cheese effect occurs when a person treated with MAO inhibitors eats food containing pressor amines. These amines stimulate the sympathetic nervous system, increasing heart rate and blood pressure. This reaction can cause blood pressure to increase enough to produce intra cranial bleeding or cardiovascular collapse. Therefore, unless strict dietary guidelines are followed, risk of hypertensive crisis is significant.

9

Antiepileptic Agents

INTRODUCTION

The epilepsies are a group of disorders characterized by chronic, recurrent, paroxysmal changes in neuralgic function caused by abnormalities in electrical activity of the brain. They are one of the common neuralgic disorders, estimated to affect 0.52% of the population and can occur at any age. The terms convulsion and seizure are often used interchangeably and basically have the same meaning. For many years, treatment options for epilepsy were limited. Over the last decade, however, many new pharmacological therapies have been introduced, and several more are in development.

TYPES OF EPILEPSY

There are four types of epilepsy. Certain signs and symptoms characterize each type ;

(a) **Grand Mal.** Grand Mal is the most common type of epilepsy. In this type of epilepsy, the person often experiences an aura (this can consist of certain sounds, fear discomfort) immediately before a seizure. Then the patient loss consciousness and has tonic-clonic convulsions. The seizures generally last from 2 to 5 minutes.

(b) **Petit Mal.** This type of epilepsy is most frequently found in children. Brief periods of blank spells or loss of speech characterizes petit mal. During the seizures, which usually last from 1 to 30 seconds, the person stops what he is doing and after the seizure resumes what he was doing before the seizure. Many persons are not aware that they have had a seizure.

(c) **Jacksonian (Focal).** This type of epilepsy is rare. It is usually associated with lesion of a certain part of the brain (cerebral cortex). Jacksonian epilepsy is characterized by focal or local clonic type convulsions of localized muscle groups (for example, thumb, big toe, and so forth). The seizures normally last from 1 to 2 minutes.

(d) **Psychomotor.** Psychomotor epilepsy is rare. It is characterized by periods of abnormal types of behavior (for example, extensive chewing or swallowing). Psychomotor seizures occur most often in children 3 years of age through adolescence. The individual may experience an aura with perceptual alterations, such as hallucinations or a strong sense of fear. The localized seizures may advance to generalized convulsions with resultant loss of consciousness.

CLASSIFICATION OF ANTICONVULSANTS

The anticonvulsants are classified as :

1. *Barbiturates* : Phenobarbital, methylphenobarbitone
2. *Hydantoins* : Phenytoin sodium, ethotoin, mephenytoin
3. *Oxazolidine diones* : Trimethadione, paramethadione
4. *Succinimides* : Phensuximide, methsuximide, ethosuximide
5. *Urea and monoacyl ureas* : Phenacemide, carbamazepine
6. *Miscellaneous antiepileptics* : Clonazepam, diazepam, primidone, sodium valproate
7. *New generation of antiepileptics* : Lamotrigine, gabapentin, vigabatrin and functionalized amino acids

MECHANISM OF ACTION OF ANTICONVULSANTS

Seizures are caused by abnormal stimulation of nerves in the brain by other nerves. Generally, anticonvulsants reduce the excitability of the neurons (nerve cells) of the brain. When neuron excitability is decreased, seizures are theoretically reduced in intensity and frequency of occurrence or, in some instances, are virtually eliminated. For some patients, only partial control of the seizure disorder may be obtained with anticonvulsant drug therapy. The mode and the site of action of anticonvulsants are not known for sure. However, it is believed that the anticonvulsants suppress seizures by depressing the cerebral (motor) cortex of the brain, thereby raising the threshold of the central nervous system (CNS) to convulsive stimuli. Therefore, the person is less likely to undergo seizures.

SPECIFIC ANTICONVULSANT DRUGS

PHENOBARBITAL

Chemistry. Phenobarbital is 5-ethyl-5-phenyl-1H, 3H, 5H-pyrimidine-2, 4, 6-trione.

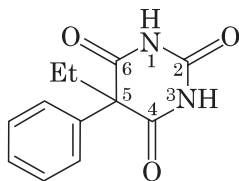

Properties. Phenobarbital occurs as a white, crystalline powder or colourless crystals, very slightly soluble in water, freely soluble in alcohol, soluble in ether. It forms water-soluble compounds with alkali hydroxides, carbonates and with ammonia. Phenobarbital sodium occurs as a white, crystalline powder, hygroscopic, freely soluble in carbon dioxide-free water, soluble in alcohol, practically insoluble in methylene chloride and in ether.

Clinical uses. Mechanism is likely related to the potentiation of GABA inhibition in the CNS. Barbiturates also antagonize glutamate excitation.

1. Phenobarbital is orally administered in the treatment of grand mal epilepsy.

- It is less effective in the treatment of petit mal and psychomotor epilepsies. The injectable form of the drug is used to treat other types of convulsions.

Adverse effects. The most common adverse effects associated with phenobarbital are sedation, dizziness, drowsiness, ataxia (lack of muscular coordination), and nystagmus (a rapid involuntary movement of the eyeball).

HYDANTOINS

- Hydantoins are cyclic monoacylureas. They possess imidazoline-2, 4-dione heterocyclic system. Hydantoins are structurally related to barbiturates, differing in lacking the 6-oxo moiety.

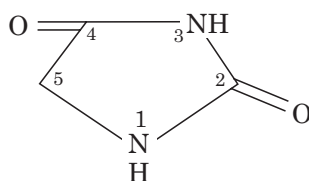

Hydantoin

- Hydantoins are weakly acidic than barbiturates. Thus aqueous solution of sodium salts provide strongly alkaline solutions.
- A clinically useful hydantoin possess an aryl substituent at the 5-position.

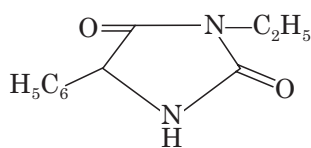

Ethotoin

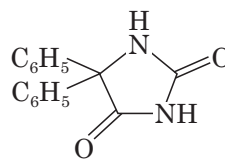

Phenytoin

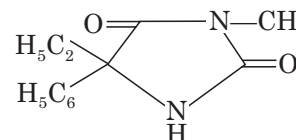

Mephenytoin

- Hydantoin derivatives possessing of lower alkyl substituents have antiabsence activity.
- Hydantoins activate Na^+ - K^+ -dependent and Ca^{++} -dependent ATPase and increase Na^+ transport.

PHENYTOIN

Chemistry. Phenytoin occurs as phenytoin sodium, chemically phenytoin is 5, 5'-diphenylhydantoin.

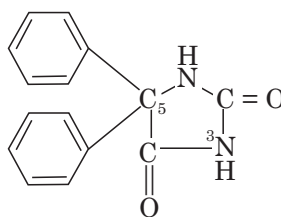

Phenytoin

Mechanism of action. Phenytoin probably works by maintaining the deactivation of voltage-sensitive sodium channels, thereby blocking the repetitive firing of neurons.

Properties. Phenytoin occurs as white, crystalline powder, slightly hygroscopic, soluble in water and in alcohol, practically insoluble in ether and in methylene chloride.

Synthesis. Phenytoin may be synthesized by heating α -bromodiphenylacetylurea with alcoholic ammonia.

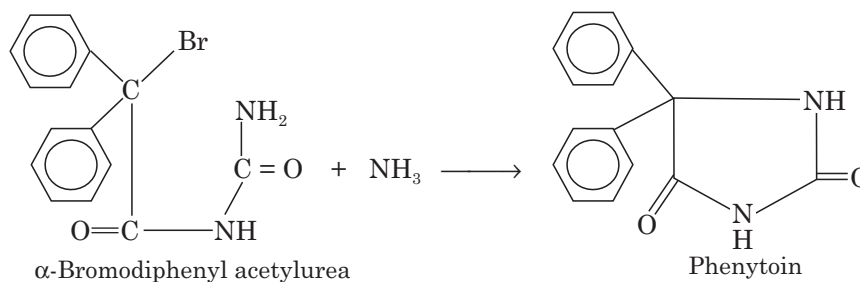

Clinical uses

1. Phenytoin is used alone or in combination with phenobarbital in the treatment of grand mal and psychomotor epilepsy.
2. It is also used in the treatment of other types of convulsions.

Adverse effects. Adverse effects associated with phenytoin include ataxia, nystagmus and slurred speech.

MEPHENYTOIN

Chemistry. Mephenytoin is a hydantoin derivative. Chemically it is 5-ethyl-3-methyl 5-phenylhydantoin.

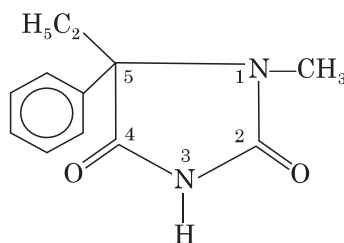

Properties. Mephenytoin is water insoluble, colorless crystalline solid. It forms a water soluble sodium salt which has an alkaline reaction.

Synthesis. Mephenytoin is prepared by the following steps :

1. In the first step cyanoethylphenyl acetamide is prepared from cyanophenyl acetamide by treatment with sodium ethoxide and ethyl iodide

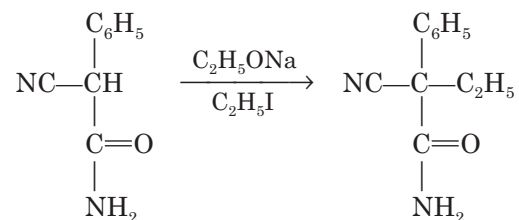

2. The product obtained by oxidation with alkaline hypobromite solution converts cyano group of cyanoethylphenyl acetamide to amide group, which isomerizes and cyclized spontaneously.

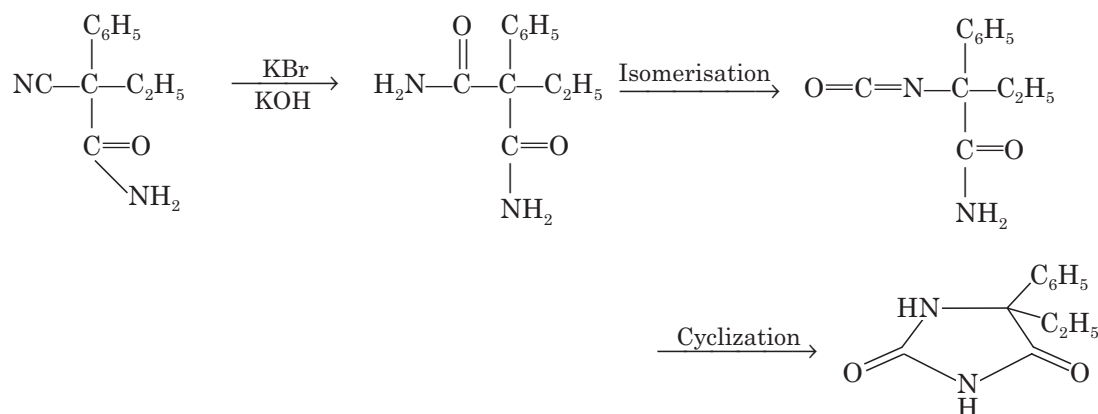

3. The above cyclized product (5-ethyl 5-phenyl hydantoin) yield mephenytoin by methylation of the nitrogen atom (which is present between two carbonyl group) with methyl sulfate or methyl iodide.

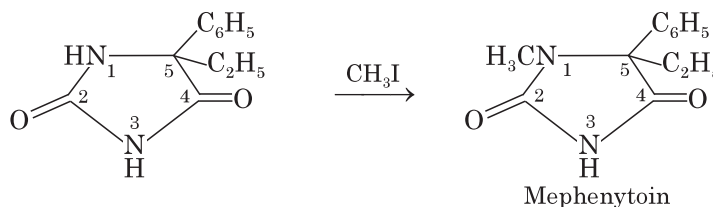

Clinical uses

1. Mephenytoin is used to control seizures in combination with phenytoin
2. It is used as a reserve drug (only when phenytoin has failed), because the metabolic product (5-ethyl-5-phenylhydantoin) of mephenytoin is highly toxic.

OXAZOLIDINEDIONES

Oxazolidinediones were introduced as anticonvulsants in 1948. They possess the following heterocyclic system :

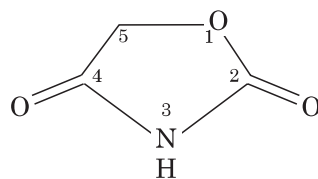

Oxazolidinedione

Oxazolidine-2, 4-dione is analogous to hydantoin differs in having of oxygen atom at position 1 instead of NH. Ex: Trimethadione, paramethadione.

TRIMETHADIONE (Troloxidone)

Chemistry. Trimethadione is an oxazolidinedione derivative. Chemically it is 3, 5, 5-trimethyloxazolidine-2,4-dione

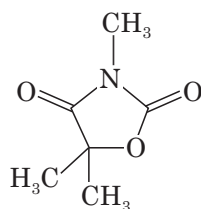

Properties. Trimethadione is colourless or almost colourless crystals, soluble in water, very soluble in alcohol and in ether. It should be protected from light.

Synthesis. Trimethadione is an oxazolidinedione derivative. It is synthesized by the following steps :

- (a) Ethyl- α -hydroxy- α -methyl propionate is condensed with urea to yield 5, 5-dimethyl oxazolidine-2, 4-dione, which treatment with a strong base followed by methylation with methyl sulphate gives trimethadione.

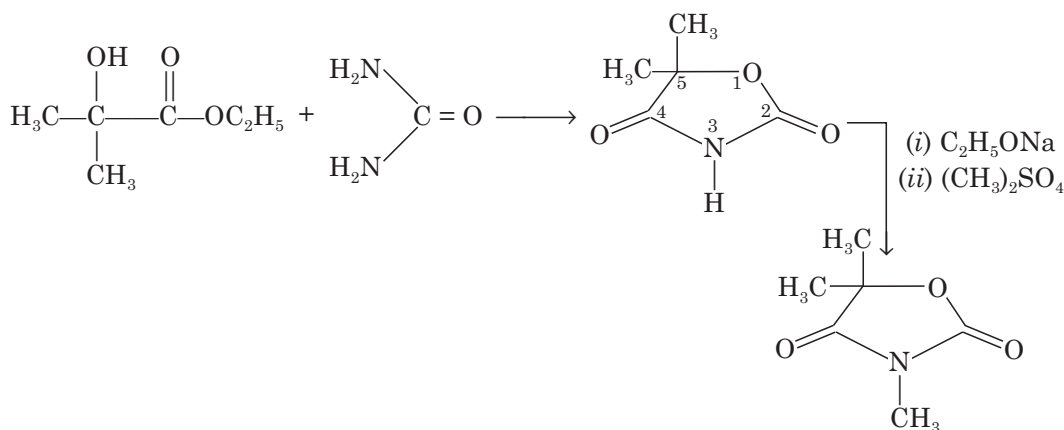

Clinical uses. Troloxidone is used in the treatment of absence seizures

PARAMETHADIONE

Chemistry. Paramethadione is 5-ethyl-3, 5-dimethyl oxazolidine-2, 4-dione. Structurally it is very closely related to trimethadione

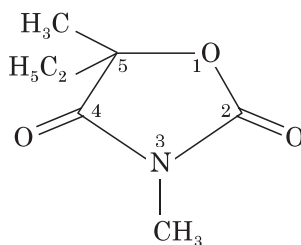

Properties. Paramethadione is available as clear, colourless liquid. It is partially miscible with water. It should be stored in a well-closed container.

Clinical Uses

Paramethadione is used in the treatment of absence seizures.

SUCCINIMIDES

Oxazolidinediones are toxic hence to replace them with less toxic drugs succinimides were introduced in 1951 as antiepileptics. The precise mechanism of action of succinimides is unknown. It has been postulated that succinimides enhances inhibitory processes in the brain, by some effect on specific inhibitory neurotransmitter systems.

PHENSUXIMIDE

Chemistry. Phensuximide is a 2,5-pyrrolidinedione derivative. Chemically it is N-methyl-2-phenylsuccinimide.

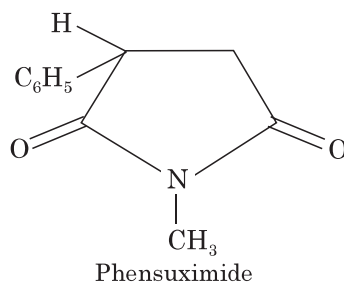

Properties. Phensuximide is white to off-white, crystalline, slightly water-soluble compound. It is freely soluble in methanol and ethanol. Aqueous solutions of phensuximide are fairly stable at pH 2-8.

Synthesis. Following is the outline for this synthesis of phensuximide :

- (a) Ethyl cyanoacetate on treatment with sodium ethoxide, is converted to its enolate anion and then, in a carbonyl condensation related to the aldol reaction and the Claisen condensation adds to the carbonyl carbon of benzaldehyde to give a tetrahedral carbonyl addition compound. Dehydration of this addition compound gives an α , β -unsaturated cyanoester (A).

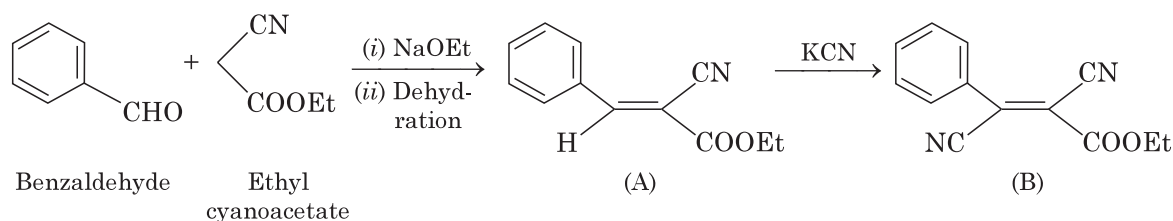

- (b) Treatment of (A) with KCN results in Michael addition of cyanide ion to the β -carbon of the α , β -unsaturated cyanoester (B).
- (c) Treatment of (B) with NaOH, H₂O results in base-promoted hydrolysis of the ester and cyano groups to carboxylic salts. Acidification with HCl and heating results in the formation of the β -dicarboxylic acid (C).

(d) Treatment of the dicarboxylic acid with ethanol in the presence of an acid catalyst such as *p*-toluenesulfonic acid converts each carboxyl group to an ethyl ester (D).

(e) Treatment of the diester with methylamine results phensuximide.

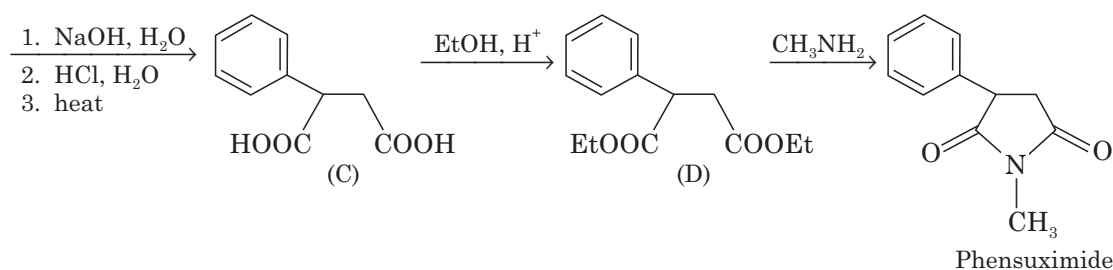

In an even more direct route to phensuximide, phenylsuccinic acid is treated with methylamine to give an ammonium salt and then heated to form the imide.

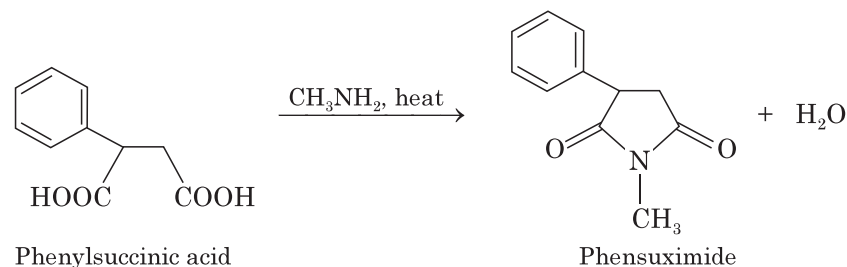

Clinical uses. Phensuximide is a succinimide antiepileptic agent used to treat convulsions but it is reported to be less effective.

ETHOSUXIMIDE

Chemistry. Ethosuximide is 2-ethyl-2-methylsuccinimide.

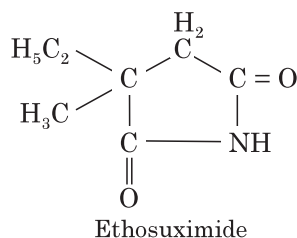

Ethosuximide has hydrogen on the imide nitrogen. It is the most acidic and has acidity comparable to that of succinimide (pK_a ; 11). The imide anion is stabilized by resonance interaction with the carbonyl groups on either side of it.

Properties. Ethosuximide occurs as a white colored, odorless powder or waxy solid having bitter taste. It is freely soluble in water.

Synthesis. Synthesis of ethosuximide, uses 2-butanone as the starting material and ammonia as the amine to form the five-membered imide ring.

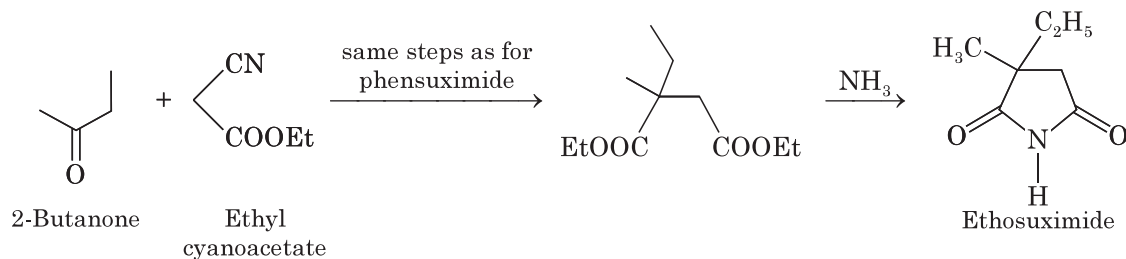

Clinical uses

- (a) Ethosuximide is the drug of first choice for the treatment of petit mal epilepsy.
 (b) To treat other types of epilepsy it may be used with other antiepileptic drugs.

Adverse effects. Drowsiness, ataxia, and gastrointestinal irritation are adverse effects associated with the use of ethosuximide.

METHSUXIMIDE

Chemistry. Methosuximide is a succinimide antiepileptic drug. It is *N*, 2-dimethyl-2-phenylsuccinimide.

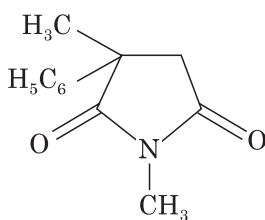

Properties. Methosuximide is a white to greyish white crystalline compound and is freely soluble in methanol.

Synthesis. Synthesis of methosuximide uses acetophenone as the starting compound.

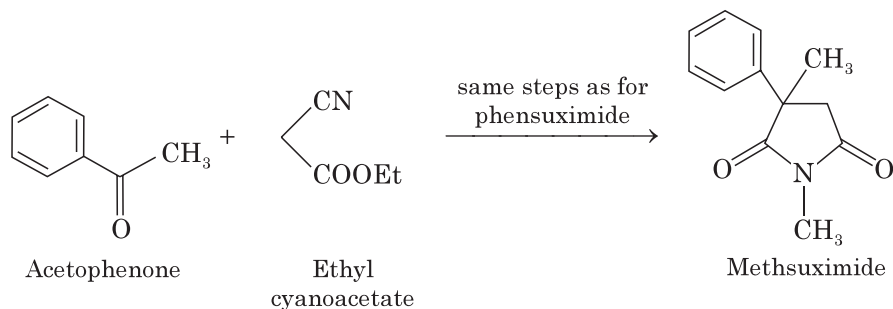

Clinical use. Methosuximide is a succinimide antiepileptic agent used to treat complex partial seizures. It is thought to owe its activity to its major metabolite *N*-desmethyl-methsuccinimide.

MISCELLANEOUS ANTI-EPILEPTIC DRUGS

CLONAZEPAM

Chemistry. Clonazepam is 5-(2-chlorophenyl)-3-dihydro-7-nitro-2H-1,4-benzodiazepin-2-one.

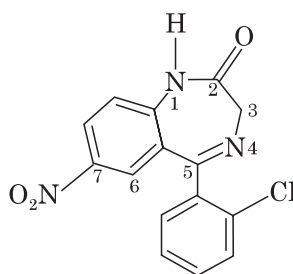

Clonazepam

Properties. Clonazepam is slightly yellowish, crystalline powder, practically insoluble in water, slightly soluble in alcohol and in methanol, very slightly soluble in ether. It melts at about 239°C.

Synthesis

Step 1. 2-Chlorobenzoic acid is treated with thionyl chloride to give an acid chloride.

Step 2. *p*-Nitroaniline is treated with acetic anhydride to form an amide, thus protecting the amino group.

Step 3. Friedel-Crafts acylation gives a diaryl ketone.

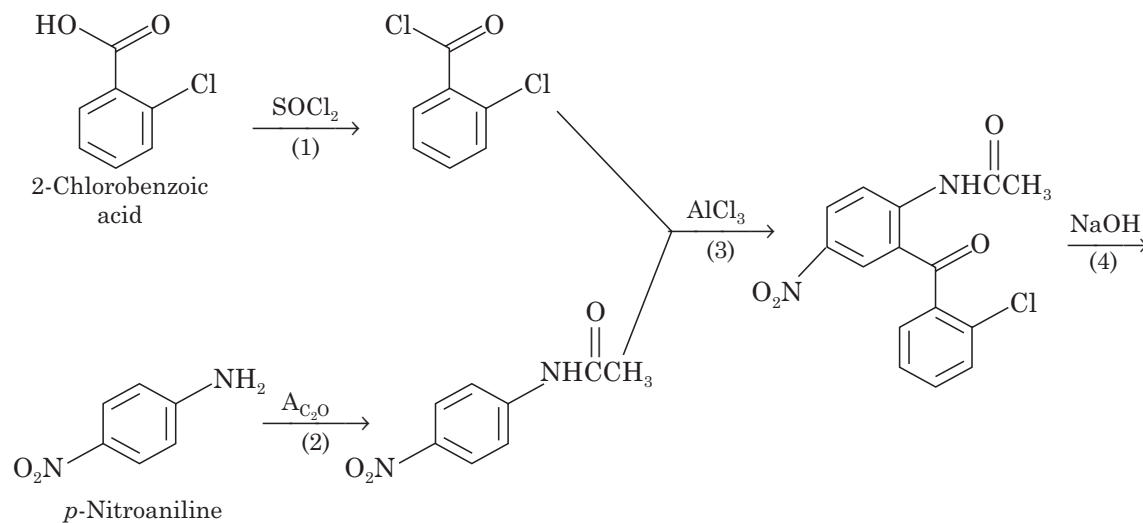

Step 4. Removal of the amine protecting by hydrolysis of the amide in aqueous base gives the free amine.

Step 5. Treatment of the amine with chloroacetyl chloride gives an α -chloroamide.

Step 6. Nucleophilic displacement of the primary chloride by ammonia gives a primary amine.

Step 7. Reaction of the primary amine with the nearby ketone gives an imine and closes the seven-membered ring of clonazepam.

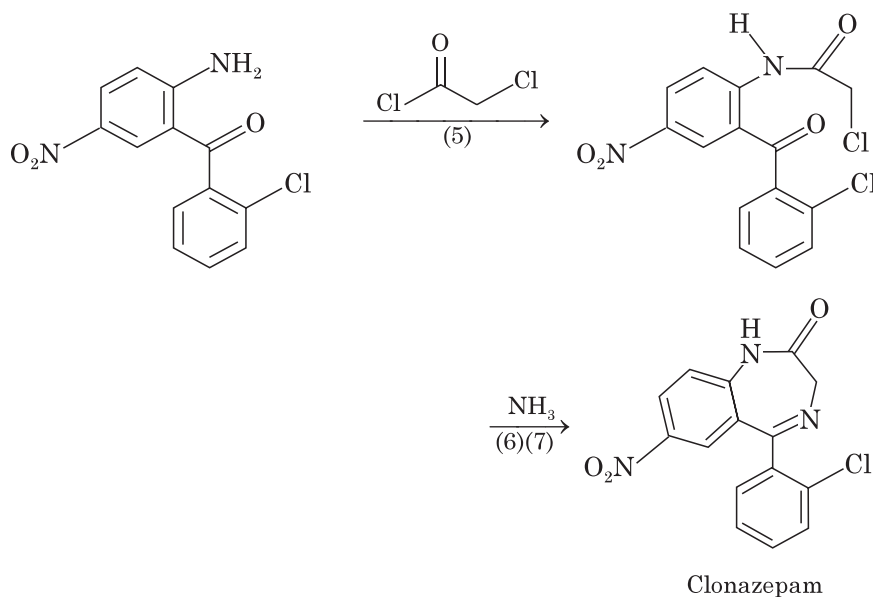

Clinical uses. Clonazepam is used in the treatment of grand mal epilepsy. It is the alternate drug for the treatment of petit mal in patients who fail to respond to ethosuximide therapy. It suppresses various types of status epilepticus seizures but because of its cardiorespiratory depressant effect, it is second to diazepam.

Adverse effects. The primary side effect associated with clonazepam is central nervous system depression. Drowsiness is frequently seen in patients who take this medication.

DIAZEPAM

Chemistry. Diazepam is a benzodiazepine derivative. Chemically it is 7-chloro-1-methyl-5-phenyl-2,3-dihydro-1H-1,4-benzodiazepin-2-one.

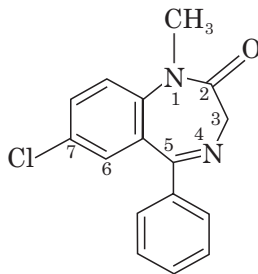

Properties. A white or almost white, crystalline powder, very slightly soluble in water, soluble in alcohol.

Synthesis

Step 1. The amine nitrogen of 4-chloro-N-methylaniline is first protected by treatment with acetic anhydride.

Step 2. Friedel-Crafts acylation is directed by the amide nitrogen, which is activating and ortho, para directing. Chlorine is also ortho, para directing but it is deactivating and, therefore, the amide nitrogen takes precedence in directing the position of further electrophilic aromatic substitution.

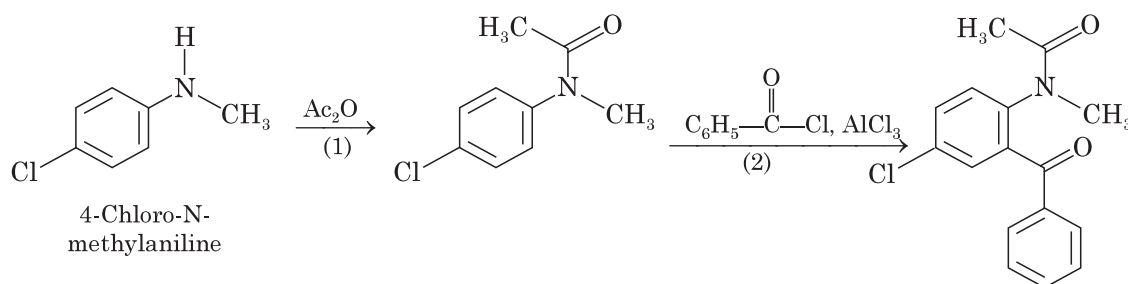

Step 3. The acetyl-protecting group is removed by treatment with aqueous NaOH to give (A).

Step 4. Treatment of the amino group of (A) with chloroacetyl chloride results in acetylation to form the amide group of (B).

Step 5. Treatment of (B) with ammonia results in nucleophilic displacement of chlorine by an S_N2 reaction to form a primary amine.

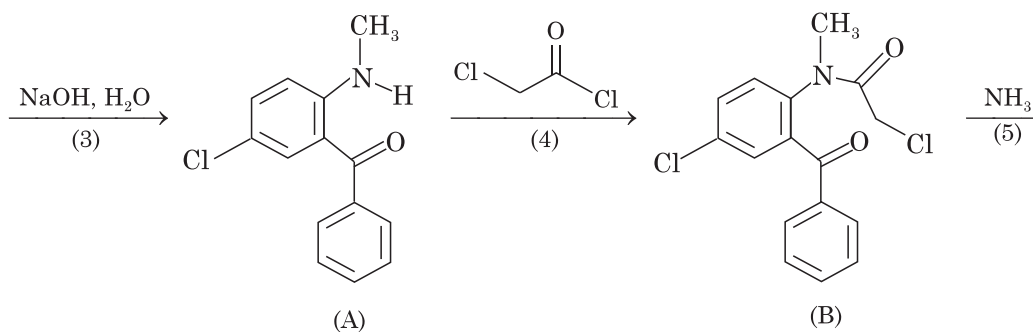

Step 6. Intramolecular reaction of the ketone and 1° amine of (B) results in formation of an imine (a Schiff base) and completes this synthesis of diazepam.

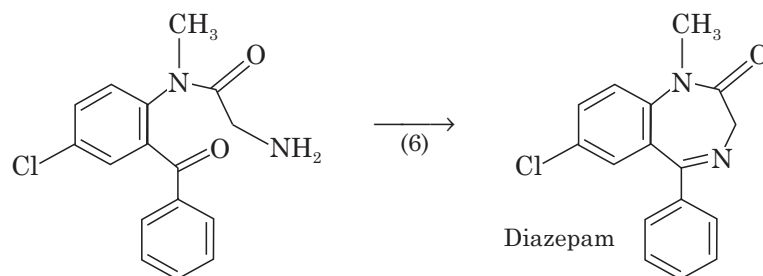

Clinical uses. Diazepam is the drug of first choice for the treatment of status epilepticus (a particular type of convulsive disorder) when it is given intravenously.

Adverse effects. Drowsiness, fatigue, and ataxia are the most common adverse effects seen with diazepam.

CARBAMAZEPINE

Chemistry. Carbamazepine is an azepine derivative possess dibenzazepine nucleus. Carbamazepine is 5*H*-dibenz[*b, f*] azepine-5-carboxamide

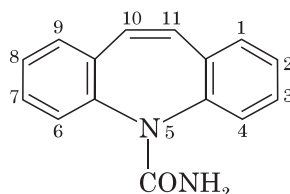

Properties. A white or almost white, crystalline powder, practically insoluble in water, freely soluble in methylene chloride, sparingly soluble in acetone and in alcohol, practically insoluble in ether. It shows polymorphism.

Synthesis. It is prepared by the following steps :

- (a) 10, 11-Dihydro-5*H*-dibenz [*b, f*] azepine by acetylation followed by bromination with N-bromosuccinimide gives N-acetyl-11-bromo dibenz [*b, f*] azepine.

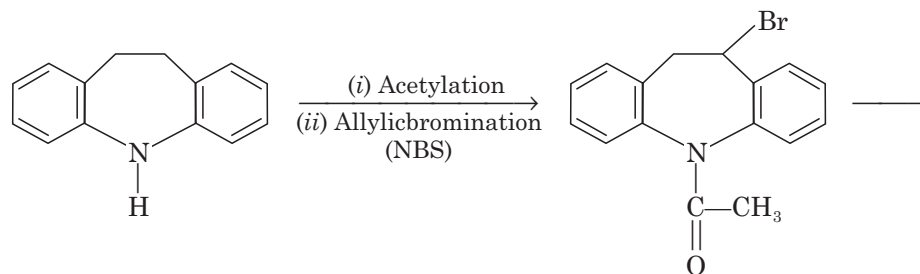

- (b) Dehydrohalogenation of N- acetyl-11-bromo dibenz [*b, f*] azepine followed by saponification with potassium hydroxide in ethanol leads to dibenz [*b, f*] azepine.

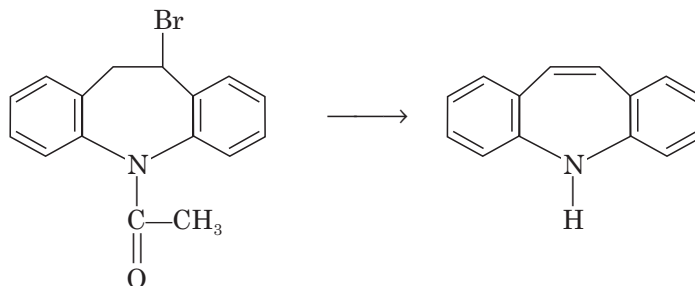

- (c) Treatment of dibenz [*b, f*] azepine with phosgene followed by heating with ammonia produces carbamazepine.

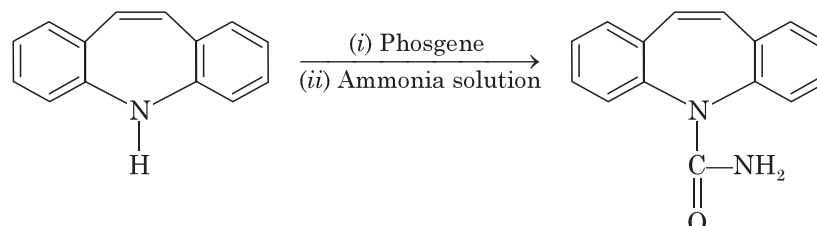

Uses. Carbamazepine is an antiepileptic drug used to control grandmal and focal seizures. It is also used in the treatment of trigeminal neuralgia and the treatment of manic depression.

PHENACEMIDE

Phenacemide is phenylacetylurea.

Properties. It is available as crystalline, slightly water soluble solid. Phenacemide is synthesised by acylation of urea with phenylacetyl chloride.

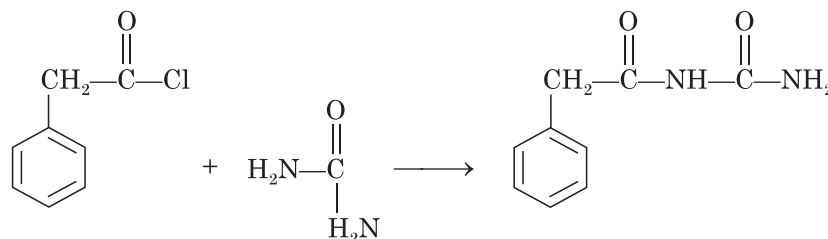

Use. Phenacemide is used as an anticonvulsant drug.

PRIMIDONE

Chemistry. Primidone is an antiepileptic agent related to barbiturates. Primidone is a diketone derived from hexahydropyrimidine. Chemically it is 5-ethyl-2, 3-dihydro-5-phenyl-4, 6-(1*H*, 5*H*)-pyrimidine dione.

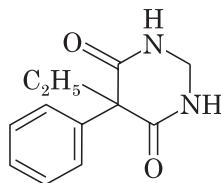

Properties. A white or almost white, crystalline powder, very slightly soluble in water, slightly soluble in alcohol, practically insoluble in ether.

Synthesis. It is prepared from diethyl ethyl phenylmalonate by following steps :

(a) Diethyl ethyl phenylmalonate is converted into its amide derivative by the action of ammonia.

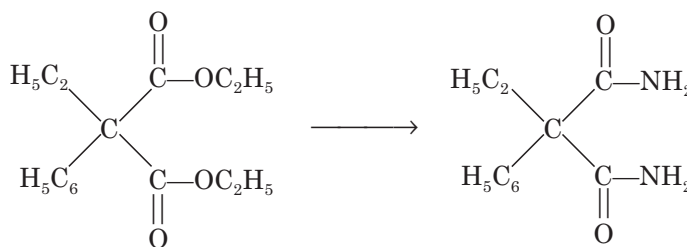

(b) Amide is refluxed with formamide to yield primidone.

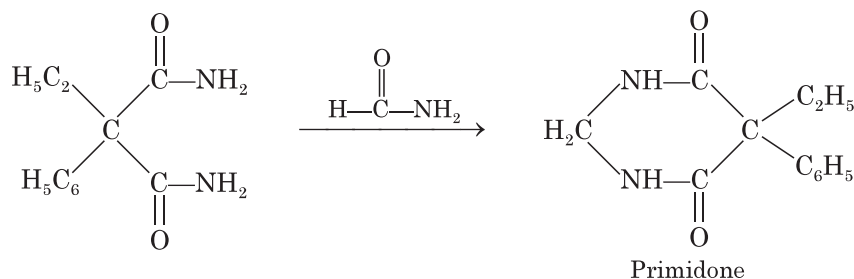

Uses. Primidone is an antiepileptic agent used to control grandmal and psychomotor seizures. It is administered orally, which is partly metabolized to phenobarbitone in the body and owes some of its actions to this metabolite.

VALPROIC ACID

Chemistry. Valproic acid was discovered as an anticonvulsant in 1963, and it was approved by the FDA for seizures in 1978. Valproic acid is 2-propylpentanoic acid. It is available as sodium valproate. Valproic acid is not chemically related to other anticonvulsants.

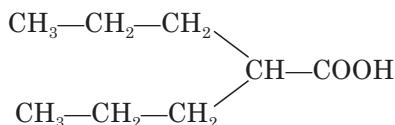

Valproic acid

Properties. Sodium valproate is hygroscopic, white, crystalline powder. It is freely soluble in water and should be stored in an airtight container.

Valproic acid is rapidly absorbed after oral administration. Peak serum levels occur approximately 1 to 4 hours after a single oral dose. Valproic acid is primarily metabolized in the liver to the glucuronide conjugate.

Synthesis. Valproic acid may be synthesized from 4-heptanol by successive conversions to 4-bromoheptane with HBr, to 4-cyanoheptane with HCN and to 2-propyl pentanoic (valproic) acid by alkaline hydrolysis of the 4-cyanoheptane.

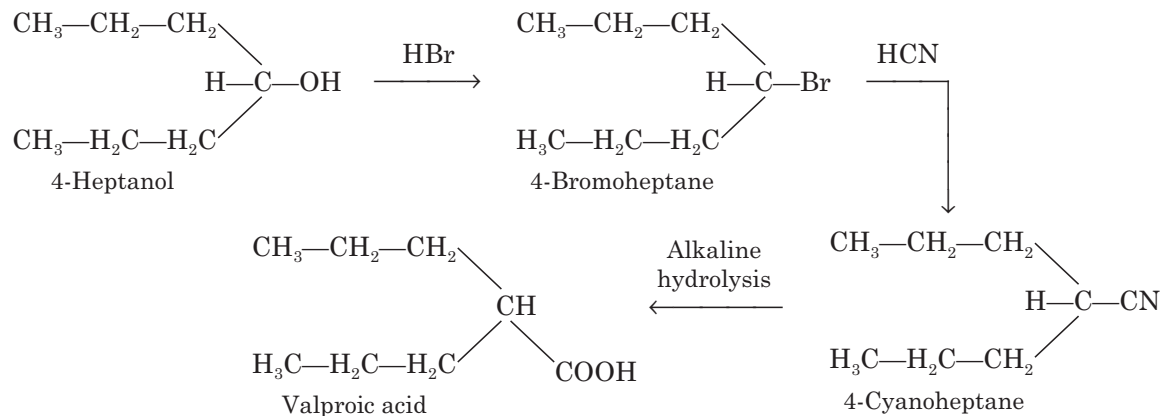

(iv) **Mechanism of action.** Sodium valproate has anticonvulsant effect. Although the exact mechanism of action is not clear, it is believed that valproic acid prevents the stimulation of nerves by increasing the concentrations in the brain of the neurotransmitter, gamma-aminobutyric acid (GABA). It acts by increasing the concentration of γ -aminobutyric acid by inhibiting the enzyme, which degrades γ -aminobutyric acid.

Uses :

1. Valproic acid is used for different types of seizures including absence seizures (petit mal seizures), generalized tonic-clonic seizures, complex partial seizures, and myoclonic seizures.
2. Sodium valproate may be effective against myoclonic and atonic seizures in young children and considered as the agent of choice.
3. Valproic acid also is used for treating bipolar mania and migraine headaches. Valproic acid is used for different types of seizures including absence seizures (petit mal seizures), generalized tonic-clonic seizures, complex partial seizures, and myoclonic seizures.

SIDE-EFFECTS OF ANTI-EPILEPTICS

1. Although various drugs are used effectively as anticonvulsants, they have numerous important side effects like sedation (seen with phenobarbitone, phenytoin and carbamazepine), gum hypertrophy and hirsutism (seen with phenytoin).
2. Majority of these drugs interfere with their own metabolism and of many other drugs, emphasizing the need for plasma level monitoring and adjustment of dosage from time to time.
3. Moreover, some patients fail to respond to these drugs both as monotherapy and combination therapy. Thus, there is a need for better anti-epileptic drugs.

NEWER ANTIEPILEPTIC DRUGS

The following new drugs are available for epilepsy, which is refractory to conventional drugs :

- | | |
|-----------------|--------------------------------|
| 1. Lamotrigine, | 2. Vigabatrin |
| 3. Gabapentin | 4. Functionalized amino acids. |

Advantages of newer anti-epileptics :

1. simpler, predictable pharmacokinetics
2. fewer adverse events
3. less effect on cognitive function
4. Low dose of drug

LAMOTRIGINE

Lamotrigine is a 1, 2, 4 triazine compound with antiepileptic profile in experimental models of epilepsy similar to phenytoin and carbamazepine. Chemically it is 6-(2,3-dichlorophenyl)-1,2,4-triazine-3, 5-diyldiamine. Lamotrigine is an interesting broad-spectrum agent, chemically unrelated to conventional agents. It acts by inhibiting release of excitatory neuro-transmitters, especially glutamate. It has proved useful as add-on therapy in resistant partial seizures, especially those whose seizures become generalised.

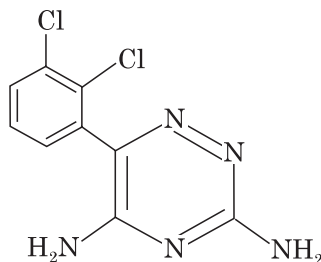

Up to 70% of patients appear to derive some benefit. It also shows promise in primary generalised seizures and in refractory childhood multiple seizure types. Preliminary studies suggest equivalent efficacy in monotherapy to carbamazepine and phenytoin. Side effects appear to be less than with phenytoin or carbamazepine and are often not greater than placebo. The most important side effect is skin rash.

VIGABATRIN

Vigabatrin is chemically 4-amino-5-hexenoic acid. As the name suggests, this drug is a structural analogue of the inhibitory neurotransmitter GABA. It acts as an inhibitor of the enzyme GABA transaminase that degrades GABA, thereby enhancing GABA activity. Because of irreversible inhibition, the effects last longer than suggested by the half-life, enabling once or twice daily administration.

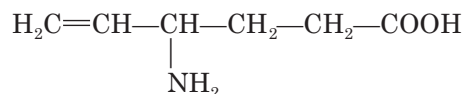

It is usually given twice daily. The same reasoning suggests that therapeutic drug monitoring will not be useful. It has proved useful as an add-on therapy in patients with partial seizures with or without secondary generalisation, with promise as monotherapy. Performance in primary generalised seizures and severe childhood seizures and myoclonic seizures is less impressive.

GABAPENTIN

Gabapentin containing primary amino and carboxyl groups, is better represented as an internal salt resulting from proton transfer from the acidic carboxyl group to the basic amino group.

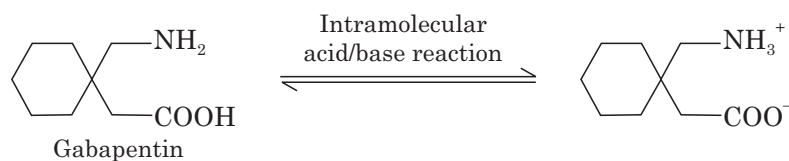

The name and structure again suggests GABA mediated pharmacology but surprisingly the mechanism of action remains unknown.

The synthesis of gabapentin involves two carbon-carbon bond-forming steps.

Step 1. When treated with sodium ethoxide, diethyl malonate is converted to its enolate anion and then, in a carbonyl condensation related to the aldol reaction and the Claisen condensation, adds to the carbonyl carbon of cyclohexanone to give a tetrahedral carbonyl addition compound. Dehydration of this addition compound gives an α,β -unsaturated diester.

Step 2. Base-promoted hydrolysis of the diester in aqueous base followed by acidification with HCl gives an α,β -unsaturated dicarboxylic acid.

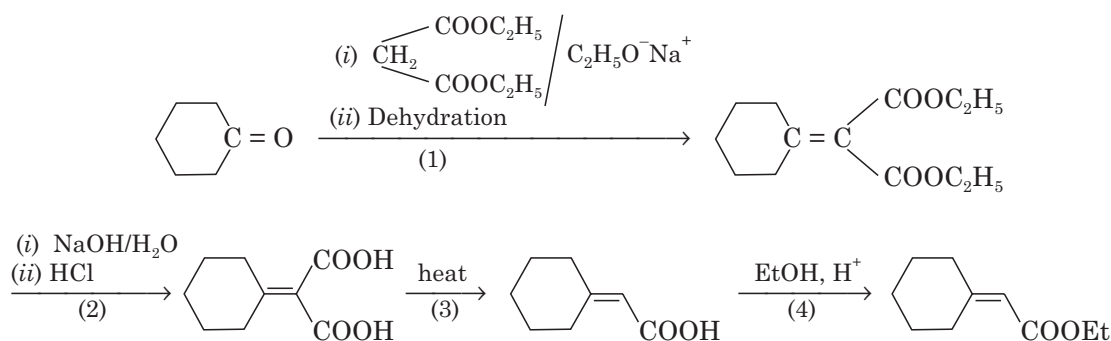

Step 3. Heating the β -dicarboxylic acid results in decarboxylation and gives an α,β -unsaturated carboxylic acid.

Step 4. Treatment of the carboxylic acid with ethanol in the presence of *p*-toluenesulfonic acid catalyst (Fischer esterification) converts the carboxyl group to an ethyl ester.

Step 5. Michael addition of cyanide ion to the α,β -unsaturated ester gives a β -cyanoester.

Step 6. Treatment of the cyano group with hydrogen over a platinum on charcoal catalyst reduces the cyano group to a primary amine.

Step 7. Hydrolysis of the ester group using either aqueous NaOH or HCl gives gabapentin.

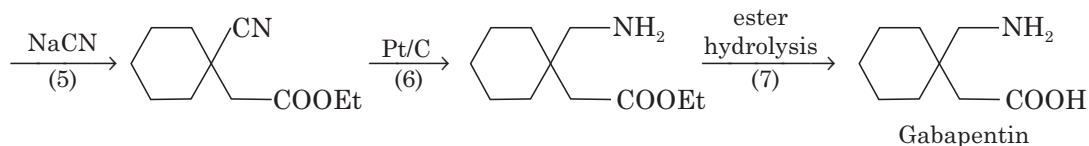

Uses. As add-on therapy in resistant partial epilepsy with or without generalisation some improvement is seen in up to 70% of patients. It has potential benefit in a wide variety of seizure types but limited experience as monotherapy. Gabapentin is well tolerated compared with conventional antiepileptics but has CNS effects such as dizziness (18%), ataxia (13%), fatigue (11%).

Functionalized amino acids as antiepileptic agents

Antiepileptic agents are ineffective in about one-third of epileptic patients. Significant antiepileptic activity exists in several functionalized amino acids (FAAs). Over 250 different FAAs have been synthesized and tested over the years. Different functional groups lead to increases (or decreases) in antiepileptic activity. Placement of an acetyl moiety at the amino

terminus and N-benzylamide at the carboxyl terminus has shown to increase the activity. Replacement of the tetrahedral carbon atom (C_2) with a trivalent nitrogen atom has shown to decrease antiepileptic activity. One important discovery was that a small, substituted heteroatom moiety positioned at C_2 site had a greatly increased antiepileptic activity. Also, the activity of these agents tends to reside primarily in the R-stereoisomer. The backbone of the functionalized amino acids can be generalized as follows:

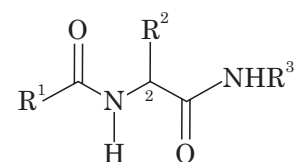

10

Cholinergic and Anticholinergic Drugs

INTRODUCTION

The nervous system is divided into the somatic nervous system, which controls organs under voluntary control (mainly muscles) and the autonomic nervous system (ANS) which regulates individual organ function and homeostasis, and for the most part is not subject to voluntary control. The autonomic nervous system is also known as the visceral or automatic system. The ANS is predominantly an efferent system transmitting impulses from the central nervous system (CNS) to peripheral organ systems. The autonomic nervous system consists of sensory neurons and motor neurons that innervates between the central nervous system (especially the hypothalamus and medulla oblongata) and various internal organs such as the : heart, lungs, viscera, glands (both exocrine and endocrine). Thus it is responsible for monitoring conditions in the internal environment and bringing about appropriate changes in them.

The ANS is divided into two separate divisions called the parasympathetic and sympathetic systems, on the basis of anatomical and functional differences. Both of these systems consist of myelinated preganglionic fibres which make synaptic connections with unmyelinated postganglionic fibres, and it is these which then innervate the effector organ. These synapses usually occur in clusters called ganglia.

The main nerves of the parasympathetic system are the tenth cranial nerve, the vagus nerve, which originate in the medulla oblongata. Other preganglionic parasympathetic neurons also extend from the brain as well as from the lower tip of the spinal cord. Each preganglionic parasympathetic neuron synapses with just a few postganglionic neurons, which are located near or in the effector organ, a muscle or major gland. Acetylcholine (ACh) is the neurotransmitter of all the pre and many of the postganglionic neurons of the parasympathetic system.

Parasympathetic stimulation causes slowing down of the heart beat, lowering of blood pressure, constriction of the pupils, increased blood flow to the skin and viscera, peristalsis of the GI tract

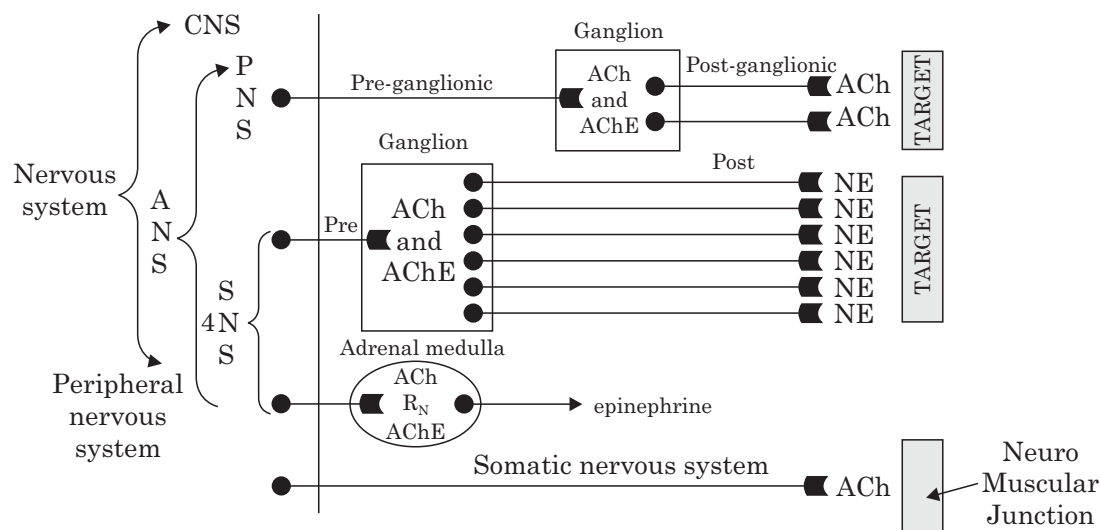

Anatomical and pharmacological characteristics of peripheral nervous system.

ANS = autonomic nervous system, PNS = parasympathetic nervous system, SNS = sympathetic nervous system, ACh = acetylcholine, AChE = acetylcholinesterase, NE = norepinephrine.

The Sympathetic Nervous System

The preganglionic motor neurons of the sympathetic system arise in the spinal cord. They pass into sympathetic ganglia, which are organized into two chains that run parallel to and on either side of the spinal cord. The neurotransmitter of the preganglionic sympathetic neurons is acetylcholine (ACh). It stimulates action potentials in the postganglionic neurons. The neurotransmitter released by the postganglionic neurons is noradrenaline (also called norepinephrine). The release of noradrenaline stimulates heartbeat, raises blood pressure, dilates the pupils, dilates the trachea and bronchi, stimulates the conversion of liver glycogen into glucose, shunts blood away from the skin and viscera to the skeletal muscles, brain, and heart, inhibits peristalsis in the GI tract, inhibits contraction of the bladder and rectum.

NEUROCHEMISTRY

A neurotransmitter is a chemical messenger used by neurons to communicate in one direction with other neurons. Communication between neurons is accomplished by the recognition by a receptor for a specific chemical messenger, picture a ball (neurotransmitter) in a cup (receptor). They are synthesized primarily in the nerve terminals, stored in vesicles of nerve terminals and are released in to the extracellular space using calcium ions. Their action is terminated by reuptake into presynaptic terminal or glial cells by specific transporter proteins or by catabolism in synaptic cleft or in presynaptic terminal.

Neurotransmitters : Chemically, there are four classes of neurotransmitters. They are :

1. Acetylcholine
2. Biogenic amines : Indolamines (serotonin and tryptamine are synthesized from tryptophan), and the catecholamines (dopamine, norepinephrine and epinephrine are synthesized from tyrosine).

3. Excitatory amino acids : There are three major amino acid neurotransmitters in the nervous system ; γ -Amino butyric acid (GABA), glycine, glutamic acid and aspartate.
4. Neuropeptides, over 50 are known.

Amino acid neurotransmitters are the most numerous except for the neuropeptides, which are synthesized in the nerve cell body and transported in vesicles along the axon to the axon terminals. All other neurotransmitters are synthesized at the axon terminals and stored in synaptic vesicles. These synaptic vesicles release neurotransmitters when the presynaptic neuron's electrical properties change sufficiently (i.e. arrival of an action potential). Neurotransmitters are released from the vesicles into a tiny space between neurons called the synapse. A bit of the released neurotransmitter diffuses across the synaptic space and binds to receptors on the adjacent neuron. The whole process takes about one millisecond.

When a neurotransmitter binds to a receptor on another neuron, ion channels open and ions move in or out of that neuron. This causes a net change in the electrical properties (membrane potential) of that neuron and determines its activity. The change may be inhibitory or excitatory, and is determined by the receptors on the postsynaptic neuron. The electrical currents that denote inhibition or excitation in a single neuron can be measured with an intracellular electrode.

ACETYLCHOLINE (ACh)

The chemical transmitter at both pre and postganglionic synapses in the parasympathetic system is acetylcholine (ACh). ACh is also the neurotransmitter at sympathetic preganglionic synapses, some sympathetic postganglionic synapses, the neuromuscular junction (somatic nervous system), and at some sites in the CNS. Acetylcholine is the most widespread autonomic transmitter present in the body.

(a) Synthesis of acetylcholine (ACh). It was first synthesized by Bayer in 1867. Acetylcholine virtually has no therapeutic effect because of its differences of action and

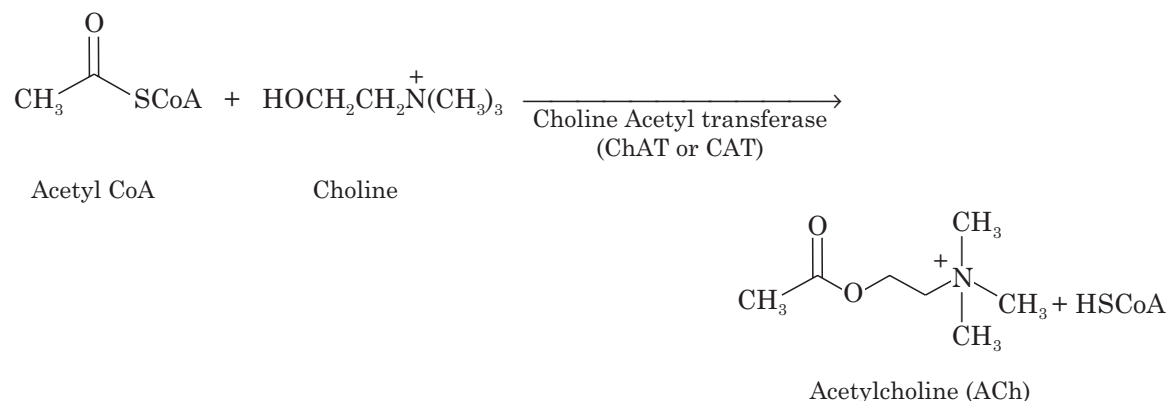

susceptability to hydrolysis by acetylcholinesterase and plasma butyrylcholinesterase. The synthesis of acetylcholine involves the reaction of choline with active acetyl (CoA). The active acetyl CoA being formed by the combination of acetate with Coenzyme A (CoA). The reaction

between acetyl Coenzyme A and choline is catalyzed by the enzyme cholineacetylase. There is considerable evidence that the enzyme cholineacetylase is synthesized within the neuronal perikaryon, then transferred along the axon to its terminals where the formation of acetylcholine is believed to occur.

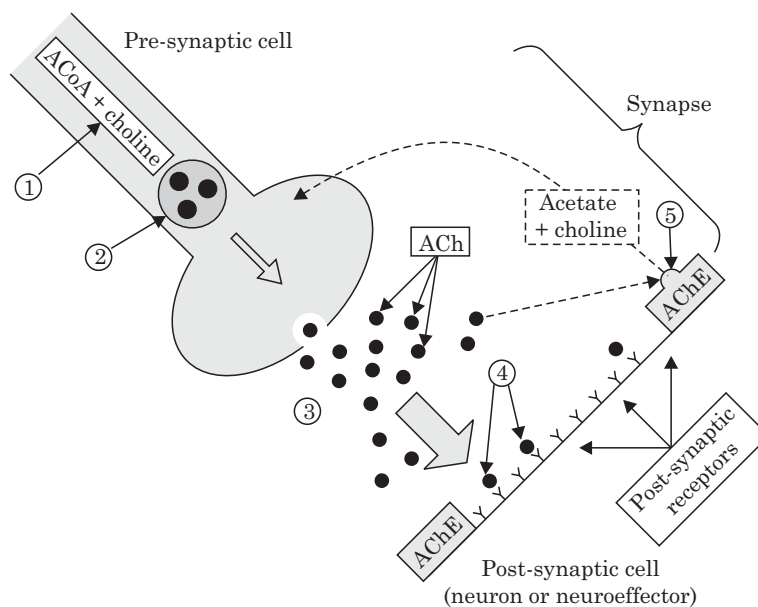

Synthesis and release of acetylcholine

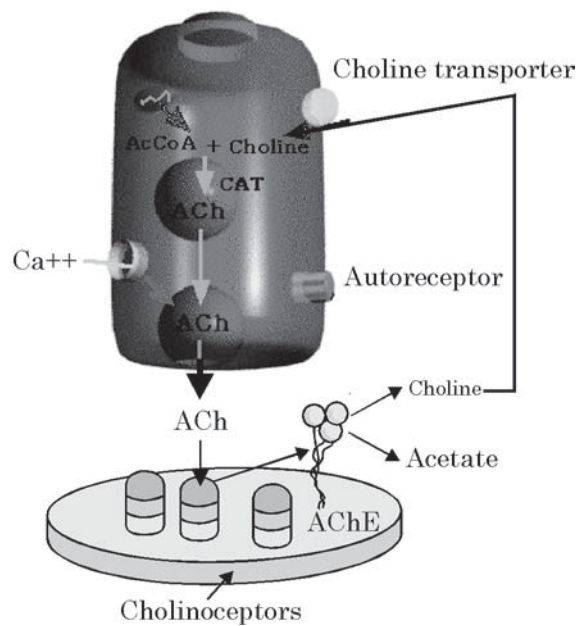

Synthesis of acetylcholine in response

(b) Storage and release of ACh. ACh is stored in synaptic vesicles, which is released as discrete “Quanta” in response to depolarization of the nerve terminal and an increased influx of Ca^{++} . When a nerve impulse occurs, depolarization of nerve terminal causes influx of Ca^{++} , which facilitates the fusion of the axonal and vesicular storage membranes, and release formed acetylcholine into the synaptic cleft by exocytosis. The released acetylcholine combines with the receptors at target organ, remains bound for less than a millisecond and is quickly hydrolysed by acetylcholinesterase enzyme into choline and acetate.

(c) Chemistry of Acetylcholine

Conformational Aspects of Acetylcholine :

(i) The following figure illustrates structure and functional groups of the acetylcholine molecule

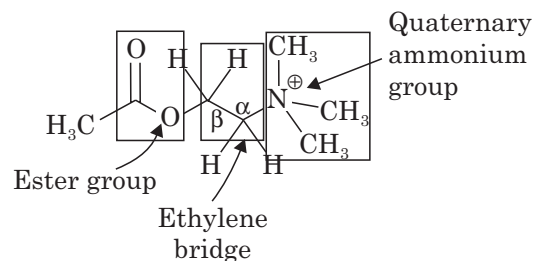

(ii) Conformational isomers of ACh derived from rotation around the -O-C-C-N axis and their nomenclatures [the receptor-bound conformation of ACh is (+) ac]

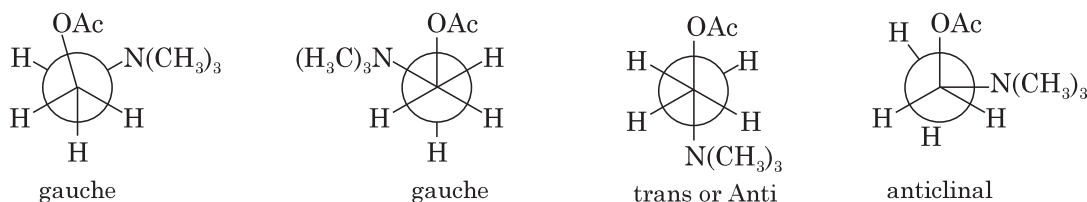

(d) Acetylcholine Receptors. There are number of different ACh receptors throughout the body. Acetylcholine acts on two different classes of receptors-nicotinic receptors and muscarinic receptors (widely distributed within both peripheral and central nervous systems).

Nicotinic Receptors. Nicotinic receptors are selectively activated by nicotine and blocked by tubocurarine or hexamethonium. These are rosette like pentameric structures which enclose a ligand gated cation channel, their activation causes opening of the channel and rapid flow of cations resulting in depolarization and generation of action potential. On the basis of location and selectivity. They are divided into two types;

N₁ : These are present at skeletal muscle endplate and mediate skeletal muscle contractions. They are selectively stimulated by phenyltrimethyl ammonium and are blocked by tubocurarine.

N₂ : These are present in ganglionic cells, adrenal medullary cells, in spinal cord and in certain areas of brain. They are primarily stimulated by dimethylphenylpiperazine and blocked by hexamethonium.

Muscarinic Receptors. Although five muscarinic receptors have been identified, helpfully labelled M_1 to M_5 , only three are well-characterised. The prototype agonist for these receptors is *muscarine*, derived from the poisonous fly agaric, *Amanita muscaria*.

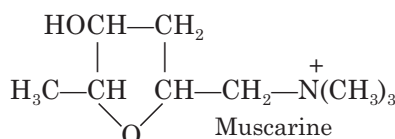

M_1 receptors are mainly found in the nervous system. They mediate *excitatory* effects, lowering transmembrane potential by a decrease in K^+ ion conductance; as an added wrinkle, they mediate increased gastric acid secretion seen with vagal stimulation. M_1 receptors work via phospholipase C, increasing IP_3 and DAG levels.

M_2 receptors mediate the cardiac effects of vagal stimulation. They are inhibitory (hyperpolarizing membranes by increasing potassium conductance). M_2 receptors are found presynaptically in a variety of situations. This fits on cardiac cells and smooth muscle. M_2 receptors lower intracellular cAMP levels.

M_3 receptors are responsible for all the other effects of parasympathetic stimulation, as they are the cholinergic excitatory receptors found on glands and smooth muscle. M_3 receptors are similar to M_1 in their use of phospholipase C. Physiology is however never simple, vascular smooth muscle *relaxes* in some situations due to M_3 receptor stimulation. This relaxation is mediated by endothelial release of nitric oxide (NO), and occurs in some vascular beds that appear devoid of parasympathetic innervation.

M_4 are similar to M_2 ; **M_5 receptors** seem similar to M_1 and M_3 in their effects.

PARASYMPATHOMIMETIC AGENTS

The terms cholinergic and parasympathomimetic are not equivalent but are generally considered as synonyms. Compounds that mimic the action of arch at parasympathetic system are called as cholinergic parasympathomimetic agents. Thus these drugs stimulate the effect of cells innervated by postganglionic parasympathetic cholinergic nerves. They are classified as directly acting and indirectly acting cholinergics.

Directly acting Cholinergic Drugs. There are two classes of the drugs : (A) choline esters and (B) cholinomimetic alkaloids

A. Choline Esters

Choline esters are synthetic derivatives of choline. They stimulate muscarinic receptors affecting the cardiac muscle, smooth muscle, exocrine glands and the eye. Choline esters are lipid insoluble and do not readily enter the CNS (effects occur primarily in the periphery). They are highly resistant to being destroyed by acetylcholinesterase (AChE).

The choline esters differ in their relative sensitivity to hydrolysis and in their relative nicotinic and muscarinic effects. Thus, methacholine, while still susceptible to hydrolysis, is much more stable than ACh, and carbachol and bethanechol are resistant to hydrolysis by AChE. Carbachol has a high level of nicotinic activity, methacholine with little nicotinic activity, and bethanechol essentially of no nicotinic activity.

Structure Activity Relationships :

- ACh is the acetyl ester of choline, and is a quaternary ammonium compound which possesses a cationic (positively charged) head joined by a two carbon chain to an ester group.
- The chemical structures of the important choline esters are given below,

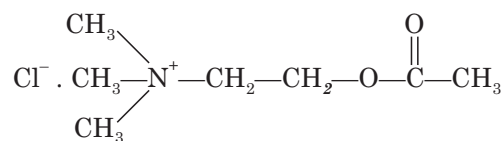

Acetylcholine chloride

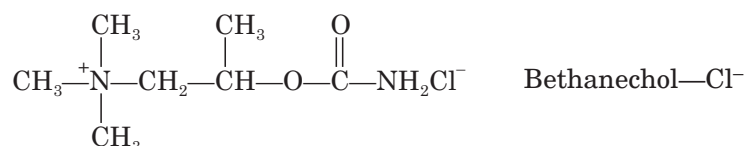
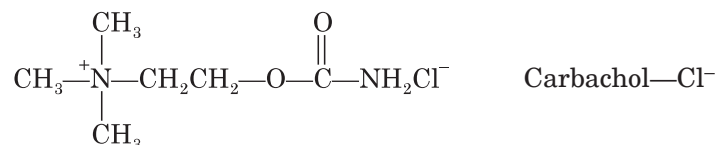
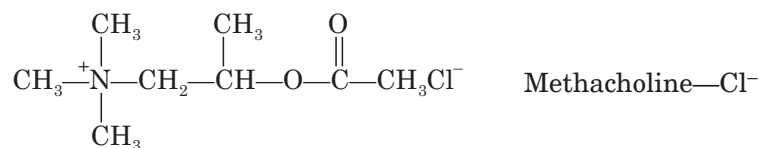

- These may differ from ACh in any of three ways,
 1. relative muscarinic activity
 2. relative nicotinic activity
 3. resistance to enzymatic hydrolysis
- The degree of muscarinic activity decreases by replacement of acetyl group, however, some substitutions result in resistance to hydrolysis
- Carbachol, where the acetyl group is replaced by a carbamyl, has both muscarinic and nicotinic properties, but is almost entirely resistant to hydrolysis by AChE or BuChE
- Bethanechol is similarly resistant to hydrolysis ; however, it possesses mainly muscarinic activity as methacholine, due to the β -methyl substitution
- Although both carbachol and bethanechol possess muscarinic activity, their effects on the heart are minimal and their GIT effects predominate
- Methacholine, conversely, has its effects predominantly on the heart.

SPECIFIC CHOLINEESTER DRUGS

Bethanechol. Bethanechol is a synthetic derivative of choline. Bethanechol is a carbamic ester of β -methylcholine. It is not rapidly hydrolysed by acetylcholinesterase and has strong muscarinic actions but little nicotinic actions.

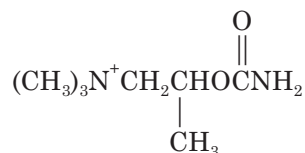

Carbamyl-beta-methylcholine/ β -Methyl choline carbamate
(bethanechol)

It produces smooth muscle contractions. It is not well absorbed from GI tract (large doses required). It can be given subcutaneously but not by IM or IV routes because of severe adverse effects. It is used in the relief of urinary retention and abdominal distention after surgery.

Bethanechol is prepared from propylenechlorohydrin. This on reaction with phosgene yields 2-chloro-1-methylethylchloroformate.

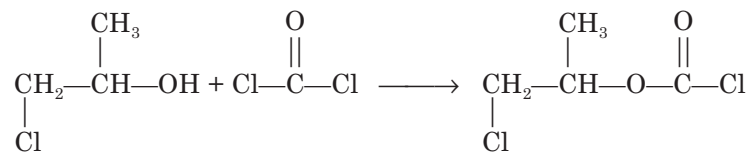

2-Chloro-1-methyl ethyl chloroformate

2-Chloro-1-methylethylchloroformate on treating with ammonia in ether solution forms urethane which on heating with trimethylamine forms bethanechol.

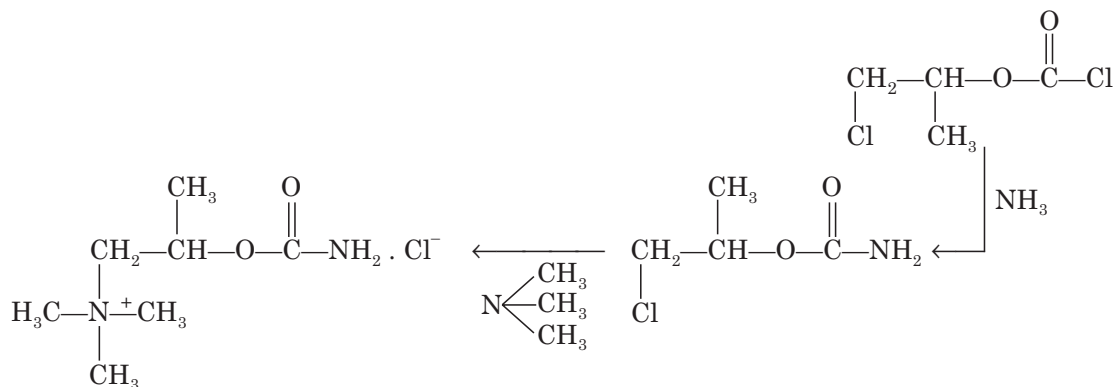

Carbachol. Carbachol is an ester of carbamic acid. In carbachol, the terminal methyl group of acetylcholine is replaced by amino ($-\text{NH}_2$) group. Carbachol is a poor substrate for acetylcholinesterase and therefore is not readily hydrolysed than acetyl choline. It has both muscarinic as well as nicotinic actions.

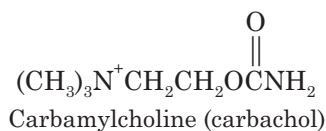

Carbachol was first synthesized by Kreitmar in 1932. Carbachol is prepared from ethylenechlorohydrin by reacting with phosgene, the resulting chloroethyl chloroformate treated with ammonia in ether solution forms urethan, which on heating with trimethylamine forms carbachol.

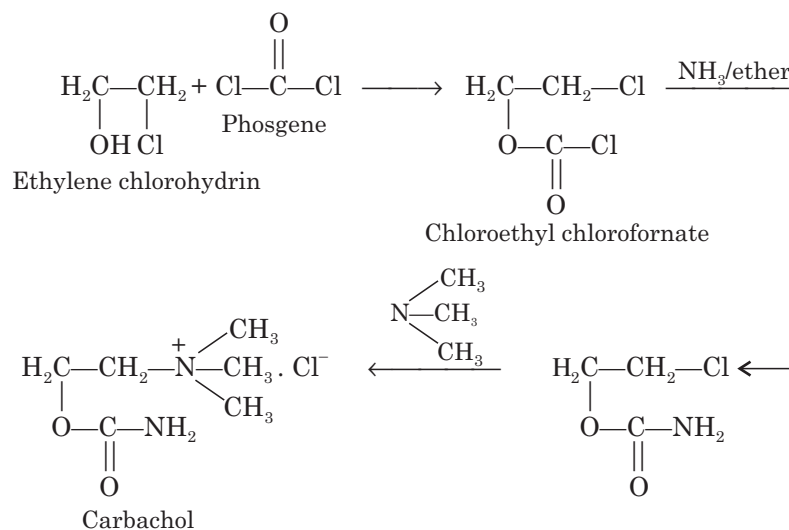

Uses. Carbachol is used to reduce intraocular pressure. Carbachol is used to induce miosis (pupil constriction) and relieves intraocular pressure of glaucoma.

Methacholine. Methacholine is available as methacholine chloride. Chemically methacholine is 2-acetoxypropyltrimethyl ammonium chloride.

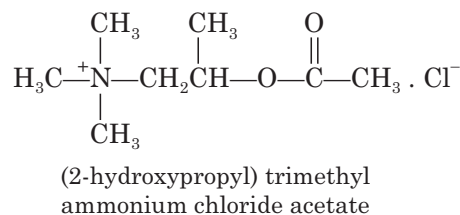

Hunt and coworkers in 1929 synthesized methacholine. It is synthesized from chloroacetone by following steps :

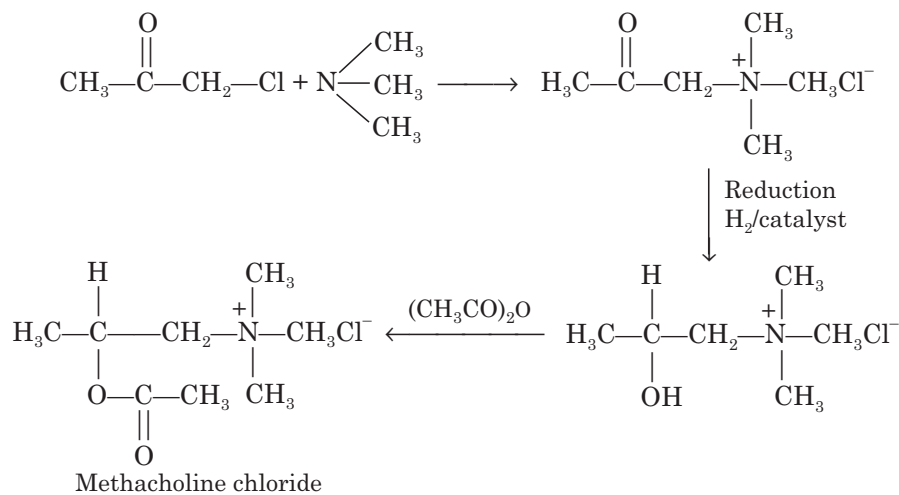

Methacholine chloride is a deliquescent crystalline solid. It is freely soluble in water. Methacholine is hydrolysed slowly than acetylcholine by acetylcholinesterase enzyme. It is used to treat Raynaud's syndrome and glaucoma.

Therapeutic uses of cholinester drugs :

1. Methacholine was used in the past to control supraventricular tachycardia and is replaced with ectrophonium and other drugs, which are safer.
2. Bethanechol is used as a G.I. tract stimulant to relieve a variety of conditions and to relieve urinary retention when there is no physical obstruction so that catheterization may be avoided.
3. ACh is used to produce brief periods of miosis during extraction of cataracts. Methacholine, bethanechol and carbachol are used in treatment of glaucoma to cause miosis which enhances drainage of aqueous humor.
4. Methacholine is also used for diagnosis of belladonna (i.e., muscarinic antagonist) poisoning, for diagnosis of familial dysautonomia, and for diagnosis of bronchial hyper reactivity (i.e., supersensitivity to bronchoconstriction in patients with asthma).

B. Cholinomimetic alkaloids

Muscarine, arecoline, pilocarpine are natural alkaloids; oxotremorine and aceclidine are of synthetic. Pilocarpine, muscarine, and oxotremorine are relatively specific for muscarinic acetyl choline receptors, while arecoline can activate nicotinic receptors.

The pharmacological actions of the alkaloids are similar to that of the choline esters: miosis, increased tone and motility of G.I. and urinary tracts, increased secretion of the exocrine glands, hypotension and bradycardia. Unlike the choline esters, these drugs cross the blood-brain barrier and therefore have profound CNS side effects.

Therapeutic Uses Cholinomimetic alkaloids. These drugs (essentially only pilocarpine) is in the treatment of glaucoma.

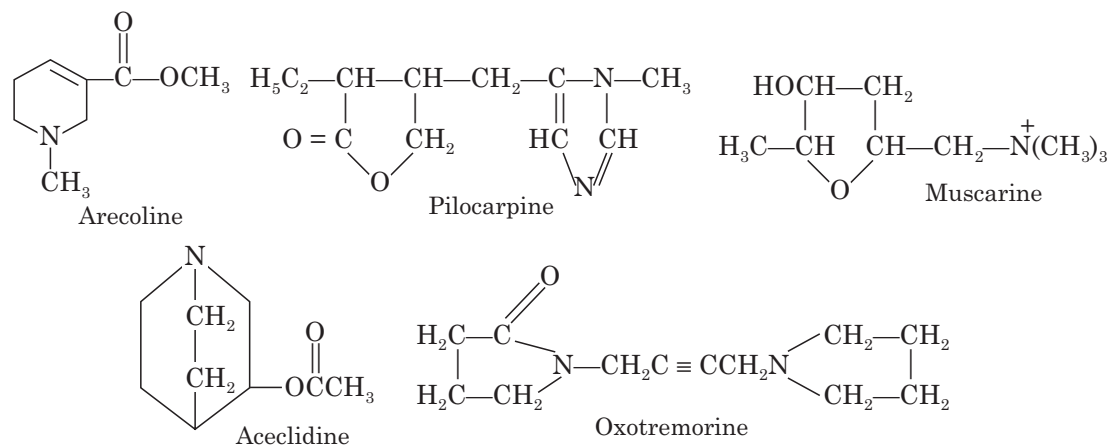

Pilocarpine. Pilocarpine is the chief constituent of the leaves of the *Pilocarpus jaborandi* of South America. It is available as hydrochloride and nitrate salt. Chemically it is 3-ethylidihydro-4[(1-methyl-1H-imidazol-5-yl)-methyl] furan-2(3H)-one.

Pilocarpine hydrochloride is an odourless, colourless, crystalline solid. It is soluble in water and alcohol. It is hygroscopic in nature and should be stored in air tight containers, protected from light.

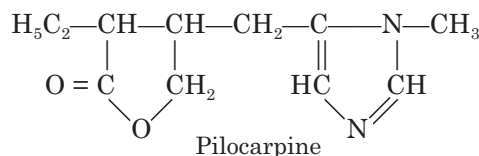

Pilocarpine, unlike many of the other quaternary agents, which penetrate membranes poorly. It can penetrate the eye when applied topically and is unaffected by acetylcholinesterase. It mainly exhibits muscarinic activity. Its use today is limited to topical miosis for the treatment of glaucoma and the reversal of mydriasis to relieve intraocular pressure of glaucoma.

INDIRECT ACTING CHLONERGIC AGONISTS (ACETYL CHOLINESTERASE INHIBITORS)

Acetylcholinesterase is a tetrameric protein which catalyzes the hydrolysis of acetylcholine. Acetylcholinesterase (AChE) has two important sites. The anionic site and esteratic site. The anionic site possesses a glutamate residue, and in esteratic site histidine imidazole ring and a serine hydroxyl group are present. The imidazole group of histidine accepts a proton from a serine hydroxyl group at the esteratic site, creating a strong nucleophilic area. The anionic site of enzyme binds with the quaternary nitrogen of the Ach through ionic and hydrophobic forces. The activated serine (strong nucleophile) attacks on the carbonyl carbon atom of acetyl choline, resulting into a tetrahedral intermediate. A tetrahedral transition state is reached, which results in serine acetylation and the loss of free choline. The acetyl group binds to histidine as an N-acetate, but is hydrolyzed rapidly to yield free choline, acetate, and the free enzyme.

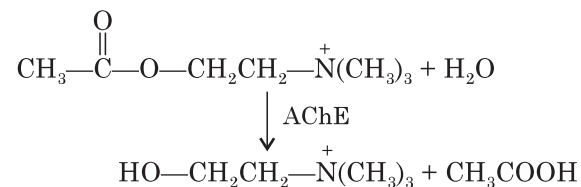

Acetylcholinesterase inhibitors have been used clinically in the treatment of myasthenia gravis. They are also employed to treat glaucoma and more recently in Alzheimer's disease. In addition, cholinesterase inhibitors are widely utilized as pesticides and, if misused, can produce toxic responses in mammals and man.

There are several classes of agents that inhibit AChE, raising ACh levels in the synapse.

A. Reversible anticholinesterase. All these drugs are structurally resemble to cholinesterase enzyme and have greater affinity for the active sites which results into a temporary inhibition of the enzyme. Hence they are termed as reversible anticholinesterases.

Carbamates: Carbamates can be represented by the following general formula ;

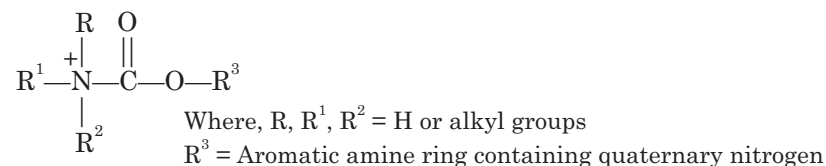

Ex : Neostigmine, physostigmine and pyridostigmine.

Physostigmine. Physostigmine, a tertiary amine, is an alkaloid obtained from the Calabar bean of West Africa (*physostigma venenosum*). Chemically it is 1, 2, 3, 3 α , 8, 8 α -hexahydro-1,3 α ,8-trimethyl-pyrrolo [2,3-b] indol-5-ol-methylcarbamate. Physostigmine is available as physostigmine salicylate and physostigmine sulphate. Physostigmine is colourless, odourless, crystalline solid. It is slightly soluble in alcohol, ether and water but freely soluble in chloroform. Physostigmine decomposes on exposure to air and light and hence it should be stored in airtight containers protected from light.

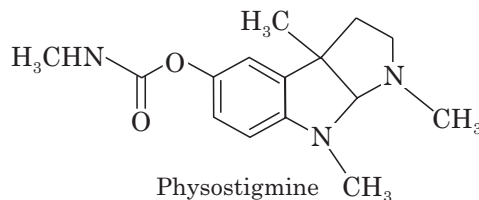

Physostigmine is prepared from powdered seeds of *physostigma venenosum* by extraction with hot alcohol. Distill off the alcohol from alcoholic extract, mix the obtained residue with sodium carbonate solution and extract into ether. Finally isolate physostigmine from ether extract after dilution with sulphuric acid.

Physostigmine reversibly inhibits acetylcholinesterase thus results in potentiation of cholinergic activity. It stimulates muscarinic, nicotinic sites of ANS and nicotinic receptors of neuromuscular junction.

Physostigmine has been used in the treatment of glaucoma, atropine intoxication and overdose with the tricyclic antidepressants.

Neostigmine. Neostigmine is a cholinesterase inhibitor. Chemically neostigmine is 3-(dimethylcarbamoyloxy)-N, N, N-trimethylaniline. Neostigmine is available as a bromide and methyl sulphate salt. Neostigmine bromide is a colourless or white coloured, odourless crystalline powder. It is soluble in water, alcohol and ether. It should be protected from light.

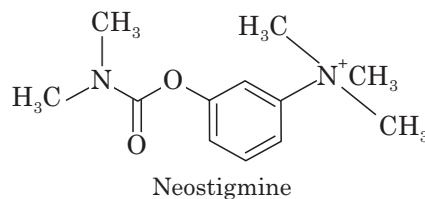

Neostigmine is synthesized from 3-hydroxy N, N-dimethylaniline as follows :

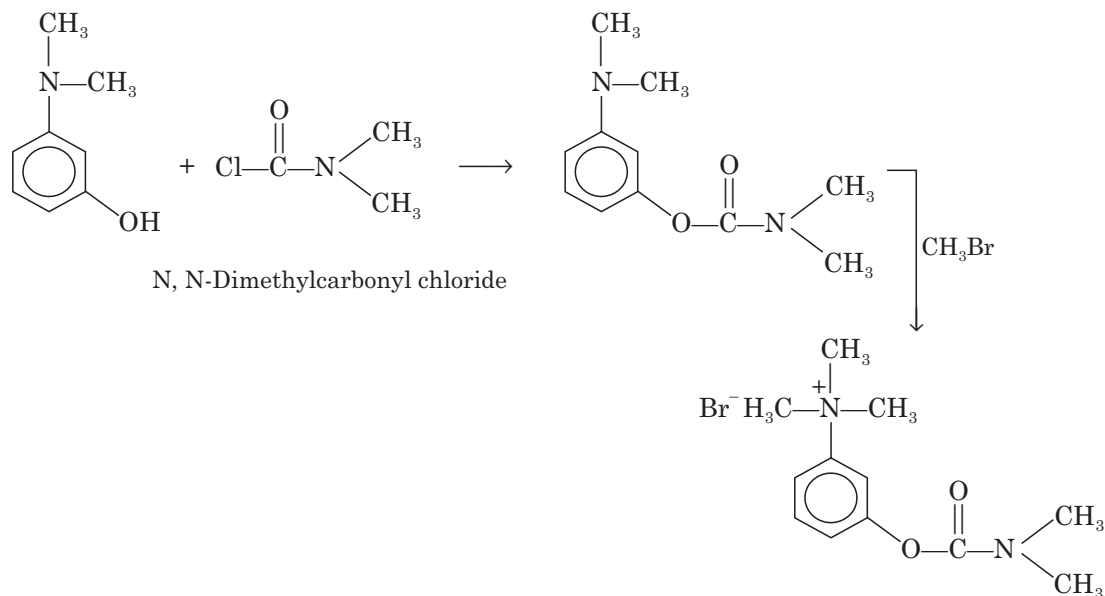

Neostigmine inhibits both AchE and butylcholinesterase reversibly and potentiates nicotinic and muscarinic effects of acetylcholine. It exists as cations at physiological pH, thus enhancing their association with the active site.

Uses. It is used to treat myasthenia gravis.

It is also used to treat constipation, post-operative distention and urinary retention.

Pyridostigmine. Pyridostigmine is a pyridine analogue of neostigmine, which is also used for the reversal of neuromuscular junction blockade and may possess a number of advantages over neostigmine. It is 3-dimethylcarbamoyloxy-1-methylpyridinium and is available as a bromide salt. Pyridostigmine bromide is a white, deliquescent, crystalline powder, having characteristic odour and bitter taste. It is soluble in water, alcohol, chloroform but very slightly soluble in ether and petroleum. It should be stored in airtight containers and protected from light.

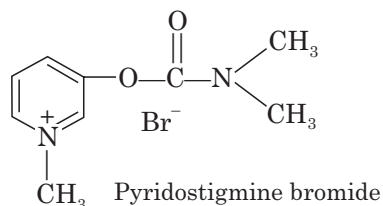

Pyridostigmine bromide can be synthesized from 3-hydroxy-1-methylpyridinium bromide by condensation with dimethylcarbamoyl chloride.

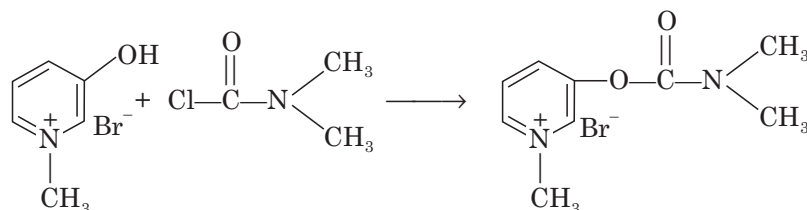

Pyridostigmine is a potent reversible inhibitor of acetylcholinesterase. By inhibiting the enzyme it permits free transmission of nerve impulses across the neuromuscular junction. It is hydrolyzed by acetylcholinesterase but much more slowly than acetylcholine itself. Pyridostigmine intensifies both the nicotinic and muscarinic effects of acetylcholine.

Uses. Pyridostigmine is used in the treatment of myasthenia gravis. It is also used in paralytic ileus or postoperative urinary retention.

Quaternary ammonium compounds

Quaternary ammonium compounds inhibit the enzyme reversibly by either binding with the esteratic site, or with a site spatially removed, termed the peripheral anionic site.

Edrophonium. Edrophonium is available as edrophonium chloride. Edrophonium chloride is Ethyl-(*m*-hydroxyphenyl) dimethylammonium chloride. It is water soluble, white crystalline powder.

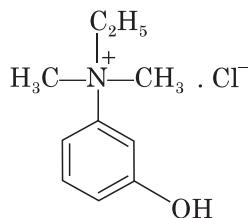

Edrophonium chloride

Edrophonium chloride is prepared from *m*-dimethylaminophenol as follows ; *m*-dimethylaminophenol is treated with ethyl iodide in an organic solvent to get dimethylethyl (*m*-hydroxyphenyl)ammonium iodide which on treatment with moist silver oxide followed by addition of hydrochloric acid forms edrophonium chloride

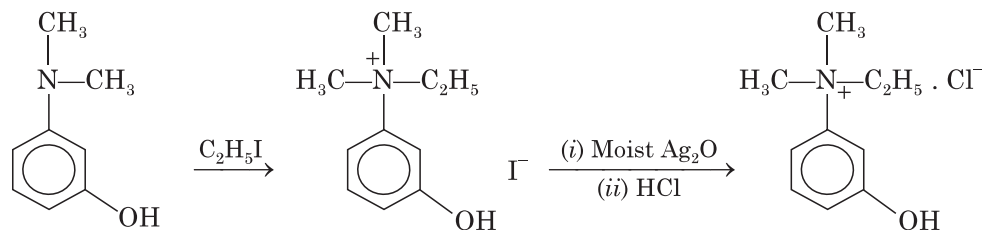

Edrophonium chloride is an anti-AChE agent with a rapid onset but short duration of action. Edrophonium binds reversibly and selectively to the active center; this reversible binding and its rapid renal elimination result in its short duration of action. It has been used in the investigation of myasthenia gravis.

Demecarium. Demecarium is available as demecarium bromide. Demecarium bromide is a diester of (m-hydroxyphenyl) trimethyl ammonium bromide with decamethylene bis (methylcarbamic acid). It consists of two neostigmine molecules linked by a chain of 10 methylene groups.

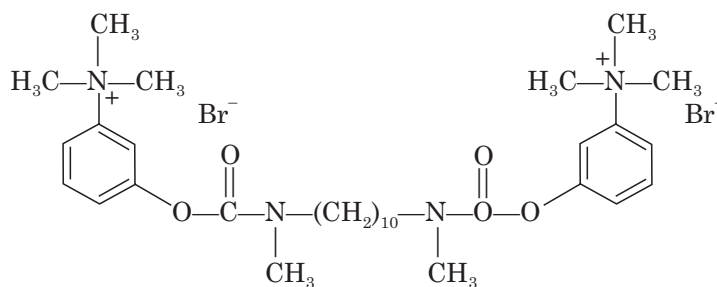

Demecarium bromide

Demecarium bromide is a colorless, slightly hygroscopic, water soluble solid. It is a potent, long acting mitotic used to treat glaucoma.

Ambenonium. Ambenonium occurs as ambenonium chloride. Chemically it is [oxalylbis(iminoethylene)] bis[(*o*-chlorobenzyl)diethylammonium]dichloride. It is white, odourless, water soluble solid.

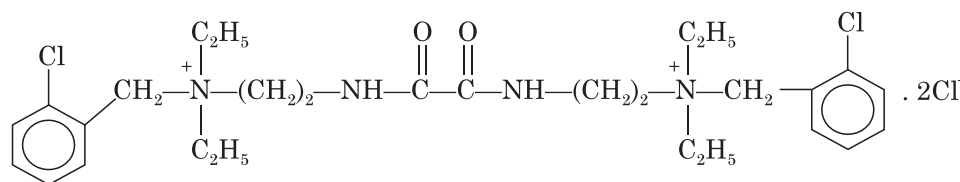

Ambenonium is used to treat myasthenia gravis. It acts by suppressing the activity of acetylcholinesterase.

B. Irreversible inhibitors

Organophosphates. Organic esters of phosphoric acid were first shown to inhibit AChE in 1937 and were subsequently used as insecticides in agriculture. All of the organophosphates irreversibly bind AChE. These compounds form reversible complex with enzyme at the esteratic site. The reversible complex then immediately converts into an irreversible complex. Organophosphates are usually represented by the following formula :

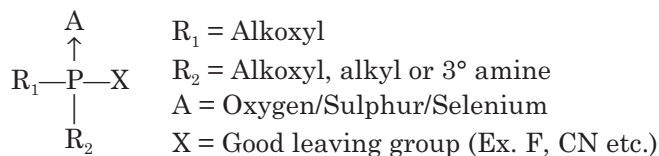

Organophosphate insecticides can enter the human body through skin absorption, inhalation and ingestion. They can affect cholinesterase activity in both red blood cells and in blood plasma, and can act directly, or in combination with other enzymes, on cholinesterase in the body. Accidental or suicidal intoxication may lead to ;

- (a) Central nervous system effects
- (b) Neuromuscular and respiratory paralysis
- (c) bronchorrhoea, bronchospasm and pulmonary oedema
- (d) bradycardia, circulatory collapse, and depressed cardiac function

Examples of drugs in this group includes :

- Echothiophate
- Pralidoxime
- Malathion
- Parathion Echothiophate

Echothiophate. Echothiophate is an organophosphate available as echothiophate iodide. Echothiophate iodide is white, crystalline characteristic odor, (mercaptan like odours) hygroscopic powder. It is soluble in water.

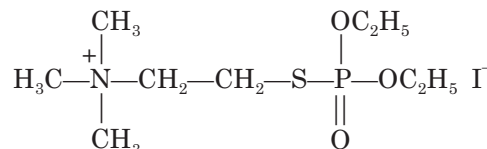

Echothiophate is a long acting irreversible anti-AChE drug that is used in the treatment of glaucoma.

Malathion. Malathion is another effective pesticide, which is more effective on insects than on humans because it requires biotransformation to the phosphate form, which can only be carried out by insects. Malathion is a phosphodithioate ester. Chemically it is 2-[(dimethoxyphosphinothioyl)thio]-butanedioic acid diethyl ester. It is a poor irreversible inhibitor of choline esterase enzyme. Malathion is available as a light amber colored liquid, having sulphur like odour.

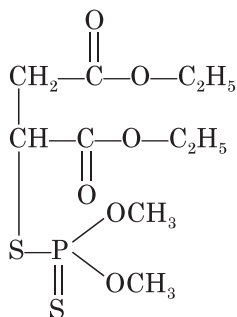

Malathion is used extensively for controlling insects on vegetables, fruits, and cereal crops. It is also used for controlling insects affecting man and animals.

Isofluorphate. Isofluorphate is an organophosphate. Isofluorphate covalently binds to acetylcholinesterase and inhibits acetyl cholinesterase irreversibly. Isofluorphate is a colorless, water-miscible liquid.

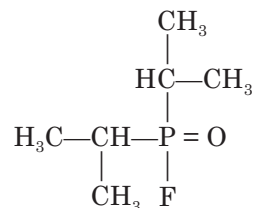

Uses. Isoflurophate is used to treat glaucoma.

Parathion. Parathion is O, O-diethyl O-*p*-nitrophenyl phosphorothioate. It is a weak cholinesterase inhibitor. Parathion occurs as a brown colored liquid.

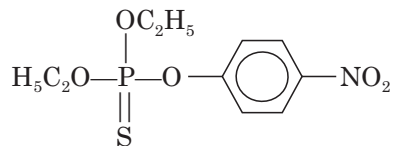

Parathion is used as an agricultural insecticide. It is especially used for controlling aphids, spider mites, and scale insects.

Pralidoxime. Pralidoxime is an aldoxime and available as pralidoxime chloride. Chemically it is 2-formyl-1-methylpyridinium chloride oxime. Pralidoxime chloride is colorless or light yellow colored, water soluble, and crystalline powder.

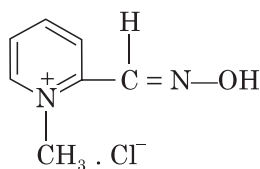

Pralidoxime chloride is synthesized from picolinal as follows :

Picolinal is converted into its oxime. The formed oxime is converted to pralidoxime methosulfate with dimethylsulphate, which on treatment with hydrochloric acid forms pralidoxime chloride

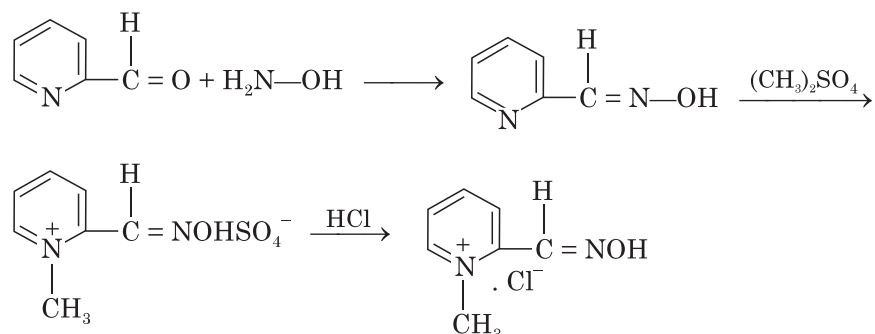

Uses. The molecule pralidoxime is a useful antidote for intoxication with cholinesterase inhibitors such as the organophosphates. The molecule removes the inhibitor from the active site in the form of an oxime phosphonate.

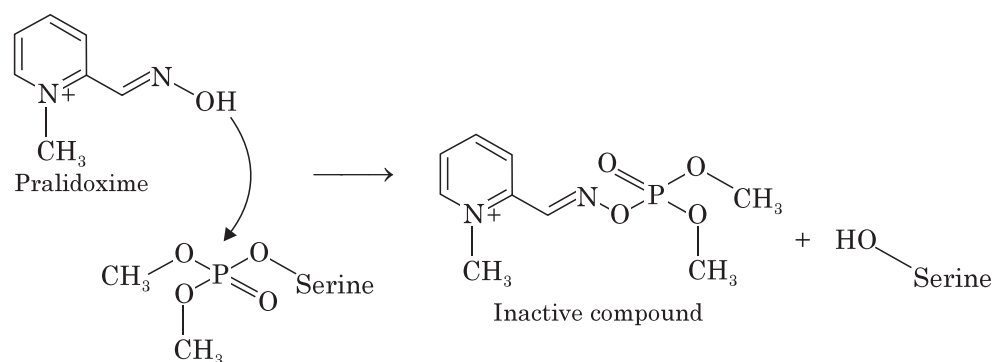

Cholinergic blocking agents

Cholinergic antagonists inhibit the actions of endogenous acetyl choline and muscarinic agonists at muscarinic receptor sites in peripheral tissues and in the CNS.

These drugs are highly specific reversible competitive antagonists for muscarinic ACh receptors. The pharmacological effects are blockage of parasympathetic stimulation at effector organs. They are rapidly absorbed from the gastrointestinal tract, slowly absorbed when applied locally on eye or skin.

The potent anticholinergics are used to control the secretion of saliva and gastric acid, slow down gut motility, and to prevent vomiting. They also have a limited therapeutic use for the treatment of Parkinson's disease.

Structure-activity Relationships of Muscarinic Antagonists :

1. Anticholinergic agents are bulky. They combine with muscarinic receptors and shield the binding site from acetylcholine. The general structure of the compounds in this category is

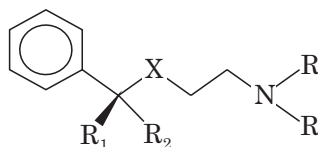

2. Substituent R₁ should be carbocyclic or heterocyclic ring for maximal antagonist activity
3. Substituent R₂ should be a hydrogen atom, hydroxy group, hydroxymethyl group, or methyl group
4. The nature of the group X effects only the duration of action, the physicochemical properties and the side effects of the drug molecule but not its ability to bind with the receptor
5. There is a limitation for the N-substitution. Optimal potency is associated with 2-3 ethyl groups

6. The stereochemistry at the benzylic carbon is critical for muscarinic antagonist activity. Any compound that can place the phenyl group in the same absolute configuration as depicted in the general formula above will have potent muscarinic antagonist activity
7. The phenyl ring cannot tolerate any their substituent than F at the *p*-position without losing its antagonist activity
8. A negative site for binding of the positive charged N ; quaternary amines have formal positive charge while tertiary amines have a positive charged proton

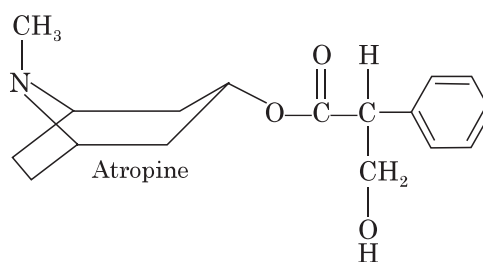

9. Atropine is a racemic mixture (equal number of *d*- and *l*-isomers) and like most chemicals acting on the peripheral nervous system, atropine is stereospecific; *l*-isomer (*l*-hyoscyamine) is 250 times more active than the *d*-isomer

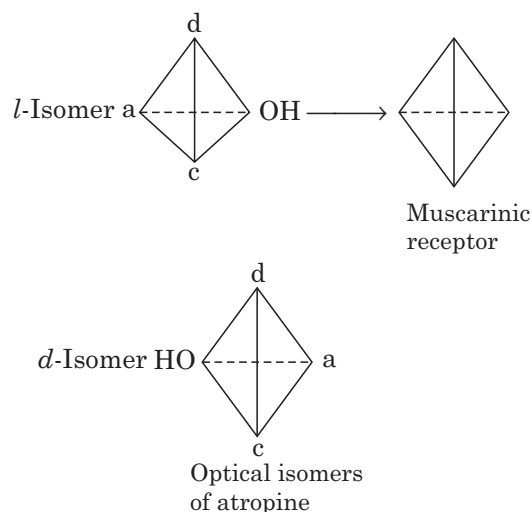

10. The presence of an N-methyl group on atropine or scopolamine changes the activity of the ligand, possibly by preventing a close interaction between the ligand and the membrane or lipophilic sites on the receptor. The methyl group also prevents the penetration into the brain.

Therapeutic uses of anticholinergic drugs

1. Peripheral: Therapeutic uses following inhibition of parasympathetic transmission, *e.g.*, mydriasis with cycloplegia, decrease saliva production, decrease motility of smooth muscle, inhibition of vagal transmission to heart, decrease bronchial secretions, decrease in urinary incontinence, etc.
2. Central: Anti-parkinson and anti-motion sickness
3. If anticholinergic drugs are non-quaternary amine derivatives, they will cross the blood-brain barrier. They may have therapeutic actions, or side effects, involving the central nervous system; if anticholinergic drugs are quaternary amines, they will not cross the blood brain barrier, thus they are devoid of CNS activity.
4. Expected 'side effects' of anticholinergic therapy include: peripheral-photophobia, cycloplegia, dry mouth, tachycardia, difficult urination, red skin ('atropine flush'), and increase in skin temperature, central-sedation or excitement.

ANTI-CHOLINERGICS DRUGS

Scopolamine or Hyoscine. Scopolamine is an alkaloid isolated from various members of solanaceae. It is an optically active compound and levoform is potent. (–) Scopolamine is slightly water miscible viscous liquid. Scopolamine occurs as Scopolamine hydrobromide salt, which is a colorless, odorless, water soluble powder.

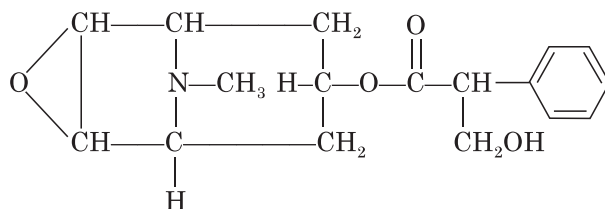

Scopolamine has pronounced CNS sedative effects, and may also be useful in preventing nausea and vomiting, especially due to motion sickness. It is also given as pre-anesthetic medication. Scopolamine has antispasmodic activity.

Homatropine Hydrobromide. Homatropine is a synthetic alkaloid and is official as homatropine hydrobromide or homatropine methylbromide. Homatropine hydrobromide is (1*R*, 3*R*, 5*S*)-3-([*RS*]-2-hydroxy-2-phenylacetoxy)-8-methyl-8-azabicyclo [3.2.1]octane hydrobromide.

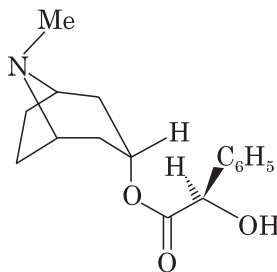

Homatropine hydrobromide and homatropine methylbromide are available as colorless crystalline, odorless powder. They are hygroscopic in nature and are soluble in water and alcohol.

It is an ester of tropine with (\pm) mandelic acid, and is prepared by the interaction of tropine and mandelic acid.

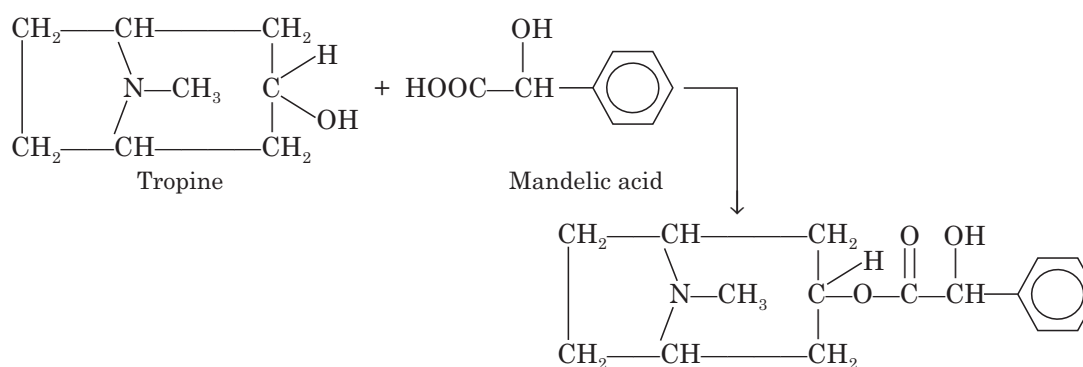

Uses :

1. Homatropine is mainly used as mydriatic and is preferred over atropine due to its more rapid and short duration of action
2. Homatropine is used to treat peptic ulcer and gastro-intestinal spasm

Hyoscyamine Sulphate. Hyoscyamine sulphate contains not less than 98.0 per cent and not more than the equivalent of 100.5 per cent of bis[(1*R*,3*R*,5*S*)-3-[(*S*)-(3-hydroxy-2-phenylpropionyl)oxy]-8-methyl-8-azabicyclo[3.2.1]octane] sulphate, calculated with reference to the dried substance.

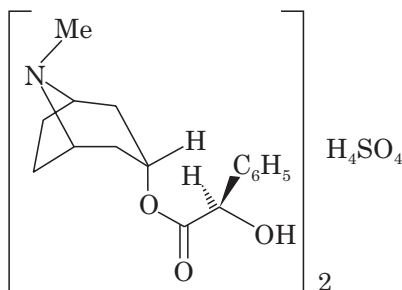

Hyoscyamine sulphate is available as white, crystalline powder or colorless needles, very soluble in water, sparingly soluble or soluble in alcohol, practically insoluble in ether. It melts at about 203°C , with decomposition. It should be stored in an airtight container, protected from light.

Use. Hyoscyamine is an anticholinergic drug used to treat peptic ulcers

Glycopyrrolate. Chemically glycopyrrolate is 3-hydroxy-1, 1-dimethylpyrrolidinium bromide α -cyclopentylmandelate.

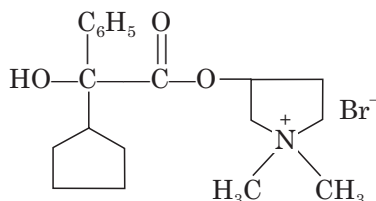

It is available as white, crystalline powder. Glycopyrrolate is soluble in water and alcohol but insoluble in chloroform and ether. It should be stored in a tightly sealed container away from heat and direct light.

Glycopyrrolate is an anticholinergic, and antispasmodic agent. Thus it diminishes gastric, pancreatic, saliva secretions. Glycopyrrolate inhibits gastrointestinal nerve receptor sites that stimulate both the secretion of gastric acid and smooth muscle activity in the *digestive* tract.

Glycopyrrolate may cause side effects; dry mouth, decreased sweating, difficulty urination, blurred vision, vision problems, loss of taste, headache, nervousness, confusion, drowsiness, weakness, dizziness, difficulty falling asleep or staying asleep, upset stomach, vomiting, constipation, bloated feeling.

Propantheline Bromide. Propantheline bromide is (Methyl)bis(1-methylethyl)[2-[(9*H*-xanthen-9-ylcarbonyl)oxy]ethyl]ammonium bromide. It is available as white or yellowish white powder. It is slightly hygroscopic, very soluble in water, in alcohol and in methylene chloride.

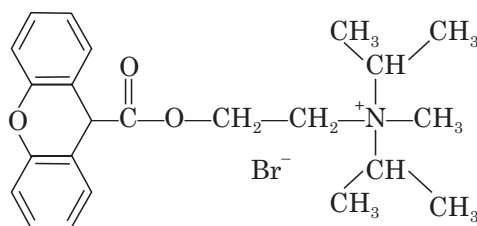

Use. Propantheline bromide has high ratio of ganglionic blocking activity to muscarinic activity. It is used as antispasmodic and in the treatment of peptic ulcers. In very high doses it can block skeletal neuromuscular junction.

Trihexyphenidyl Hydrochloride. Trihexyphenidyl Hydrochloride is 1-cyclohexyl-1-phenyl-3-piperidinopropan-1-ol hydrochloride. It is an M_1 receptor antagonist.

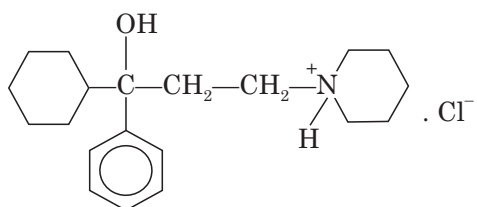

Trihexyphenidyl hydrochloride is synthesized from acetophenone by Mannich reaction as follows ;

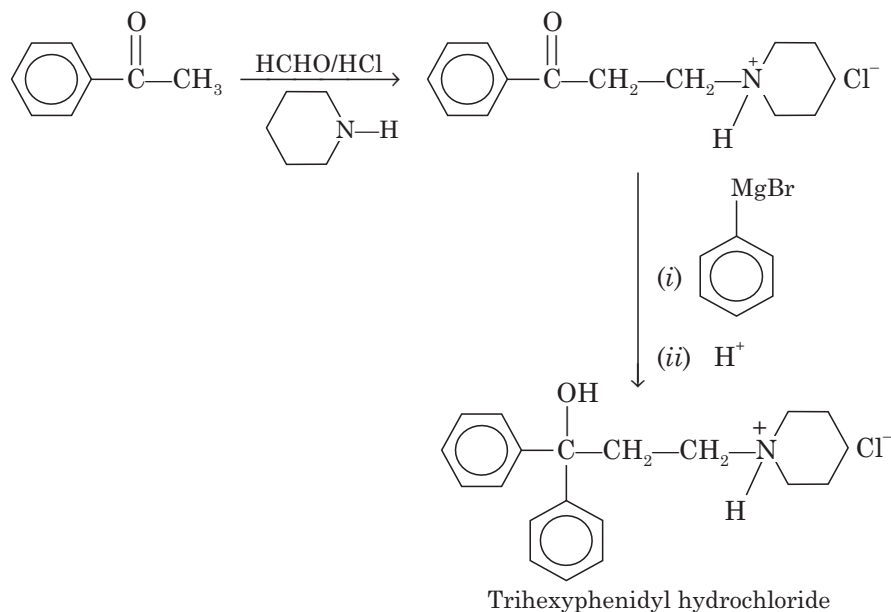

It is white or creamy white, crystalline powder, odorless. Slightly soluble in water, soluble in chloroform, in ethanol (96%) and in methanol.

Use. Used in treatment of Parkinson's disease.

Isopropamide iodide. Isopropamide is an aminoamide and occurs as isopropamide iodide. Chemically isopropamide is (3-carbamoyl-3, 3-diphenyl propyl) diisopropylmethyl ammonium iodide.

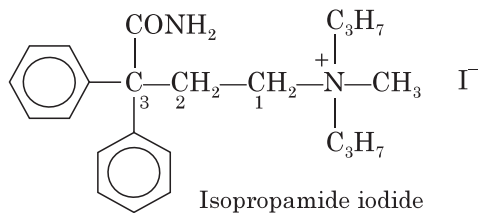

Isopropamide iodide is pale yellow coloured, bitter taste crystalline powder. It is sparingly soluble in water and freely soluble in chloroform and alcohol.

Uses :

1. Isopropamide is a potent anticholinergic drug.
2. It has antispasmodic and antisecretory effects.
3. It is used in the treatment of peptic ulcer.

Oxyphencyclimine

Oxyphencyclimine is an aminoalcohol ester occurs as its hydrochloride salt. Chemically it is (1,4,5,6-tetrahydro-1-methyl-2-pyrimidinyl) methyl α -phenylcyclohexaneglycolate monohydrochloride.

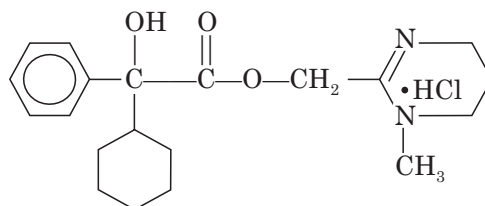

Oxypheencyclimine is a peripheral anticholinergicantisecretory agent. It has little curare-like and ganglionic blocking activities. It is used as an antispasmodic agent.

Tropicamide. Tropicamide is (RS)-N-ethyl-2-phenyl-N-(4-pyridylmethyl) hydroacrylamide. It is white, crystalline powder, slightly soluble in water, freely soluble in alcohol and in methylene chloride. It is an effective anticholinergic drug for ophthalmic use. It antagonizes M_4 receptors.

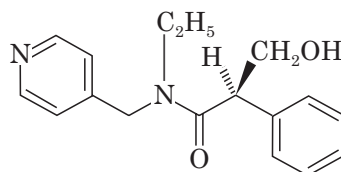

Tropicamide is synthesized by following reactions ;

In the first step tropic acid is esterified with acetyl chloride to tropic acid acetate, which is converted to the corresponding acid chloride with thionyl chloride

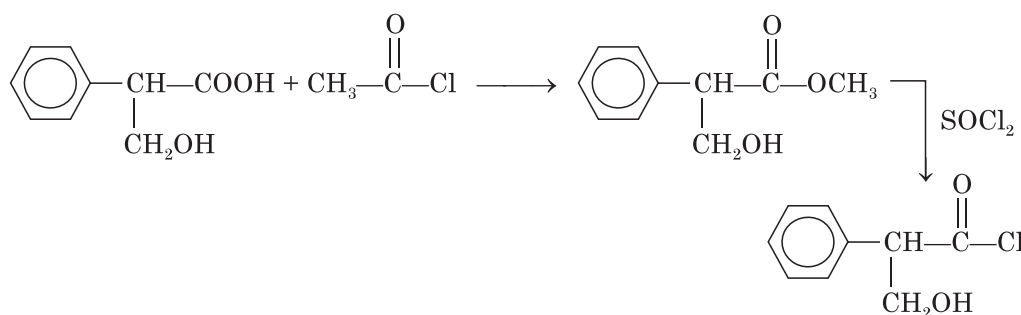

Condensation of acid chloride of tropic acid acetate with 4-[(ethylamino)methyl]pyridine in presence of dehydrochlorinating agent yields tropicamide acetate ester. The obtained tropicamide acetate ester saponifies to tropicamide :

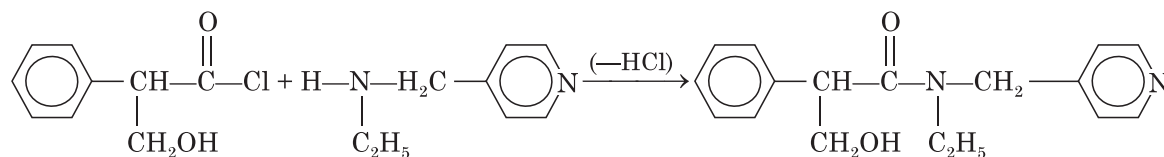

Uses. Tropicamide is a very short acting mydriatic and cycloplegic

Diphemanil. Diphemanil occurs as diphemanil methylsulfate. Chemically it is 4-(diphenyl methylene)-1, 1-dimethyl piperidinium methyl sulfate.

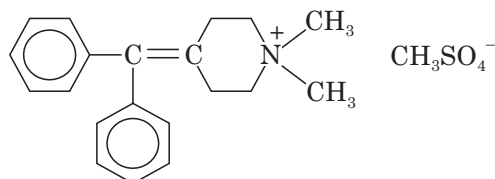

Diphemanil methylsulfate is a potent cholinergic blocking agent which blocks the nerve impulses at parasympathetic ganglia.

Uses. Diphemanil methylsulfate is used to treat peptic ulcer

Poldine Methylsulfate. Poldine methylsulfate is (RS)-2-benzoyloxymethyl-1, 1-dimethylpyrrolidinium methyl sulphate. It has antimuscarinic and ganglionic blocking activity.

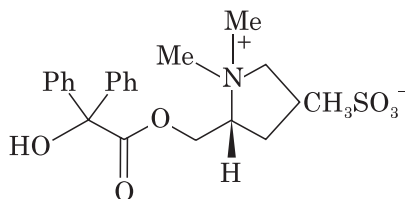

It is available as a white, crystalline powder, odorless and it is freely soluble in water, soluble in ethanol, slightly soluble in chloroform and melts at 137° to 142°.

Use. Poldine methylsulfate is used as an antispasmodic at a dose of 10-30 mg.

Procyclidine Hydrochloride. Procyclidine is an effective peripheral anticholinergic aminoalcohol derivative. It occurs as a white, crystalline, odorless powder. It is sparingly soluble in water ; soluble in ethanol (96%) ; practically insoluble in acetone and in ether. Procyclidine occurs as procyclidine hydrochloride salt. Procyclidine hydrochloride is (RS)-1-cyclohexyl-1-phenyl-3-pyrrolidin-1-ol-ylpropan-1-ol hydrochloride.

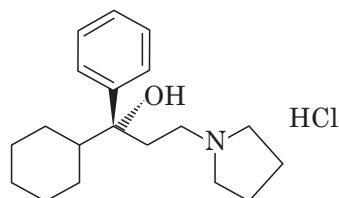

Use. Procyclidine is used in treatment of Parkinson's disease

Biperiden Hydrochloride. Biperiden hydrochloride is (RS)-1-[(1RS,2RS,4RS)-bicyclo[2.2.1]hept-5-en-2-yl]-1-phenyl-3-(piperidin-1-yl)propan-1-ol hydrochloride.

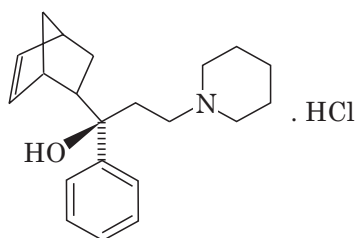

Properties. Biperiden hydrochloride is white, crystalline powder, slightly soluble in water and in alcohol, very slightly soluble in methylene chloride, practically insoluble in ether. It melts at about 280°C with decomposition. Biperiden is a weak visceral anticholinergic agent. It has strong nicotinic action.

Uses.

1. Biperiden is used to treat parkinson's disease
2. It is also used to cure akinesia, rigidity and tremor

Benztropine Mesylate. Benztropine mesylate is an aminoalcohol ether. It is (1R, 3R, 5S) -3-benzhydryloxytropane methanesulphonate. It is available as a white, crystalline powder, odourless. Very soluble in water, freely soluble in ethanol, practically insoluble in ether. Melting point, 142° to 144°

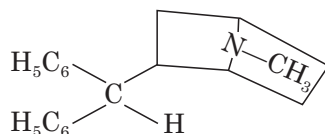

Uses. Benztropine mesylate has anticholinergic, antihistaminic and local anaesthetic activities. It is also used in the treatment of Parkinson's disease.

Piperidolate. Piperidolate is a piperidine derivative. Chemically it is *o*-phenylbenzeneacetic acid 1-ethyl-3-piperidinyl ester. Piperidolate occurs as water soluble hydrochloride salt. It is synthesized by the following steps :

- (i) Furfural by reductive amination yields aminomethyltetrahydrofuran

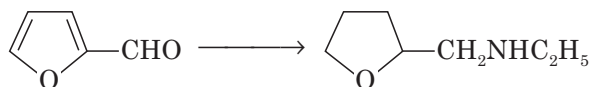

- (ii) Aminomethyltetrahydrofuran on treatment with hydrogen bromide in acetic acid forms 3-hydroxy N-ethylpiperidine, which by acylation with diphenylacetyl chloride gives piperidolate.

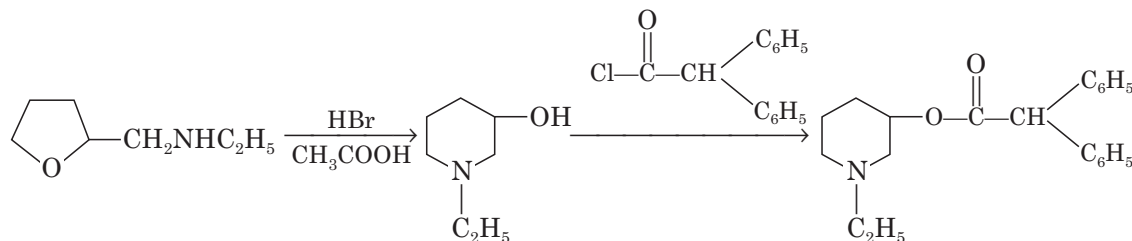

Piperidolate is used as an anticholinergic drug.

Mepenzolate. Mepenzolate is an aminoalcohol ester. Mepenzolate is available as mepenzolate bromide, chemically mepenzolate bromide is 3-hydroxy-1, 1-dimethyl piperidinium bromide benzilate.

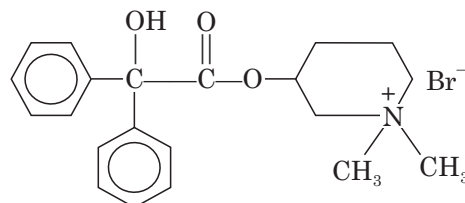

Mepenzolate bromide

Mepenzolate has anticholinergic activity. Hence it is used to treat spastic colon, irritable bowel, ulcerative colitis and duodenal ulcer.

Dicyclomine. Dicyclomine is an aminoalcohol ester and is available as hydrochloride salt. Dicyclomine hydrochloride is 2-(diethylamino)ethyl bicyclohexyl-1-carboxylate hydrochloride. A white or almost white, crystalline powder, soluble in water, freely soluble in alcohol and in methylene chloride. It shows polymorphism.

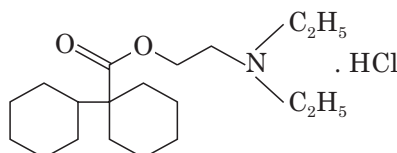

Dicyclomine is synthesized from cyclohexyl nitrile by the following steps :

- (a) Cyclohexyl nitrile on alkylation with 1, 5-dibromopentane yields a cyclohexane intermediate, which is hydrolysed to get acid.

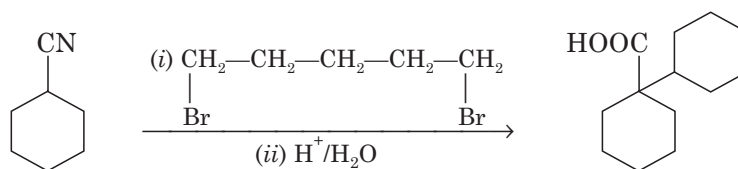

- (b) The above acid is esterified with N, N-diethylamino ethanol to get dicyclomine.

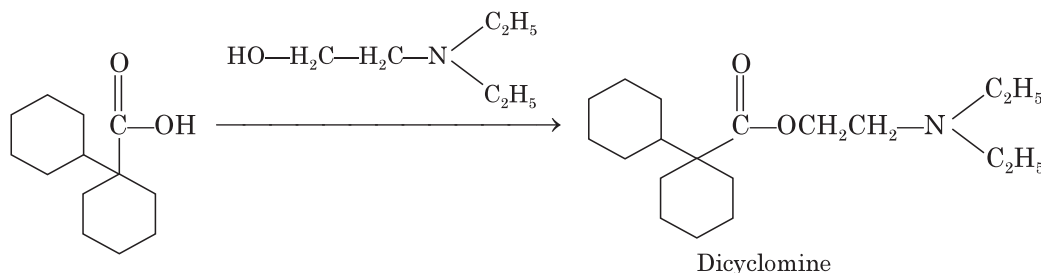

Dicyclomine is an anticholinergic and antispasmodic. It relieves smooth muscle spasm in the GI tract and urinary tract. This effect is due to direct action on the pain muscle. It is used to treat intestinal, biliary, renal and ureteric colic, irritable bowel syndrome and dysmenorrhoea.

Clidinium bromide. Clidinium is another aminoalcohol ester available as bromide. Clidinium bromide is 3-hydroxy-1-methylquinuclidinium bromide. It is available as colorless,

odorless, crystalline powder. It is an optically active compound. It is soluble in water, and alcohol.

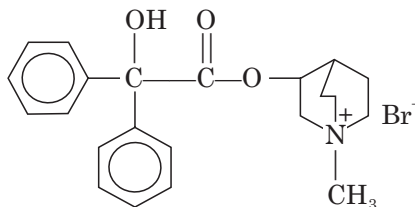

Uses :

1. Clidinium bromide is an anticholinergic agent
2. It is used for the treatment of peptic ulcer, hyperchlorhydria, and ulcerative or spastic colon

Cyclopentolate hydrochloride. Cyclopentolate is also an aminoalcohol ester.

Cyclopentolate hydrochloride is 2-(dimethylamino)-ethyl-1-hydroxy- α -phenylcyclopentane acetate hydrochloride.

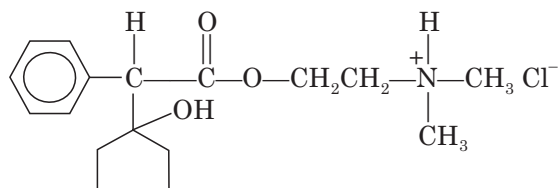

Cyclopentolate hydrochloride is available as colorless, odorless, crystalline powder. It is soluble in water and in alcohol.

Uses :

1. Cyclopentolate hydrochloride is used as a mydriatic agent
2. It is used for the treatment of iritis, keratitis, and choroiditis

Orphenadrine citrate. Orphenadrine is an aminoalcohol ether derivative.

Orphenadrine citrate is (RS)-N, N-dimethyl-[2-(*o*-methyl- α -phenylbenzyloxy) ethyl] amine citrate. It has anticholinergic and antihistaminic activities.

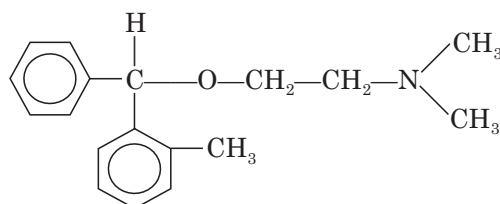

It is available as a white or almost white, odorless, crystalline powder. Sparingly soluble in water, slightly soluble in ethanol, practically insoluble in chloroform and in ether. It melts at 135° to 138°C.

Uses. Orphenadrine is used for symptomatic treatment of Parkinson's disease. It is also used as skeletal muscle relaxant.

11

Adrenergic Drugs

INTRODUCTION

The sympathetic system activates and prepares the body for vigorous muscular activity, stress, and emergencies. Adrenergic drugs stimulate the adrenergic nerves directly by mimicking the action of norepinephrine or indirectly by stimulating the release of norepinephrine.

Therapeutically, these drugs are used to combat life-threatening disorders, which include acute attacks of bronchial asthma, shock, cardiac arrest, and allergic reactions. In addition these drugs are used as nasal decongestants and appetite suppressants.

ADRENERGIC NERVE TRANSMISSION

Adrenergic nerves release the neurotransmitters; Norepinephrine (noradrenaline, (NE)), epinephrine (EP), and dopamine (DA)). Norepinephrine is released from the nerve ending in response to a nerve impulse or drug (3). NE interacts with alpha and beta-receptor sites at (4). Its receptor action is terminated by recapture and storage in the original nerve ending or inactivated by an enzyme.

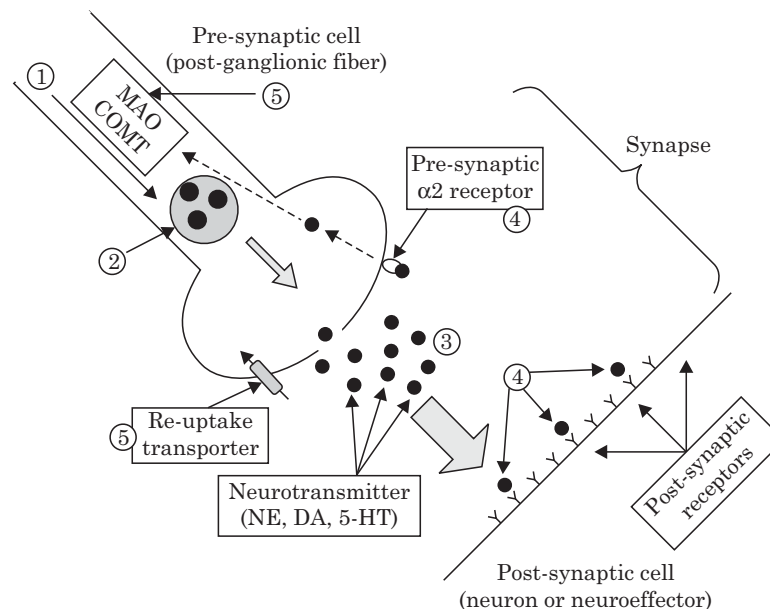

Synthesis and release of neurotransmitters from adrenergic nerves

SYNTHESIS, STORAGE AND RELEASE OF CATECHOLAMINES

The following steps in the synthesis of adrenaline were proposed by *Blaschko* (1939):

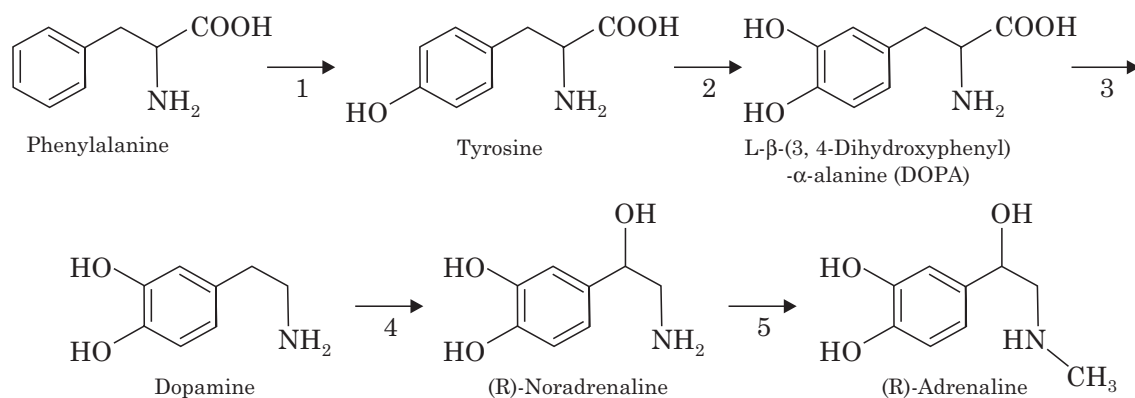

1. Phenylalanine-hydroxylase,
2. Tyrosine-hydroxylase,
3. Aromatic amino-acid decarboxylase,
4. Dopamine- β -hydroxylase,
5. Phenylethanolamine-N-methyl transferase.

Biosynthesis of catecholamines

Five enzymes are involved in the pathway of the biosynthesis of adrenaline. The first enzyme is the iron containing phenylalanine-hydroxylase (also called phenylalanine-4-monooxygenase). The second enzyme, tyrosine-hydroxylase, contains iron, too, and catalyses the conversion of tyrosine to L- β -(3,4-dihydroxyphenyl)- α -alanine (DOPA). After decarboxylation of DOPA to dopamine (aromatic amino-acid decarboxylase) the copper-containing enzyme dopamine- β -hydroxylase converts dopamine to noradrenaline. The final enzyme noradrenaline-N-methyltransferase then methylates noradrenaline to adrenaline.

The noradrenaline formed in the adrenergic nerve endings remain stored in vesicles as its adenosine triphosphate complex. The adrenal medulla also synthesizes and stores noradrenaline and adrenaline.

The neurotransmitters are released by increasing the permeability of nerve terminal membrane to Ca^{++} . The inflow of Ca^{++} triggers the fusion of vesicle with the cell membrane, resulting in exocytosis.

METABOLISM AND DISTRIBUTION OF THE CATECHOLAMINES

The actions of adrenaline and noradrenaline are terminated by three processes ;

1. Re-uptake into the nerve terminal
2. Dilution by diffusion from the junctional cleft and uptake at non-neuronal sites, and
3. Metabolic transformation

Two enzymes namely monoaminoxidase (MAO) and catechol-*o*-methyl transferase (COMT) are important in the biotransformations of catecholamines. COMT and MAO are distributed widely throughout the body, including the brain the highest concentrations of each are found in the liver and kidney. They differ in their cytosolic locations.

NE released intraneurally is initially deaminated by MAO to 3,4-dihydroxyphenylglycol aldehyde (DOPGAL). The aldehyde group is reduced to glycol by aldehyde reductase, yielding 3,4-dihydroxy-phenylethylene glycol (DOPEG). Aldehyde dehydrogenase converts 3,4-dihydroxyphenyl glycolaldehyde to 3,4-dihydroxy-mandelic acid (DOMA). The final common metabolites formed by the action of COMT are DOMA (3-methoxy-4-hydroxy mandelic acid) is VMA (3-methoxy-4-hydroxymandelic acid).

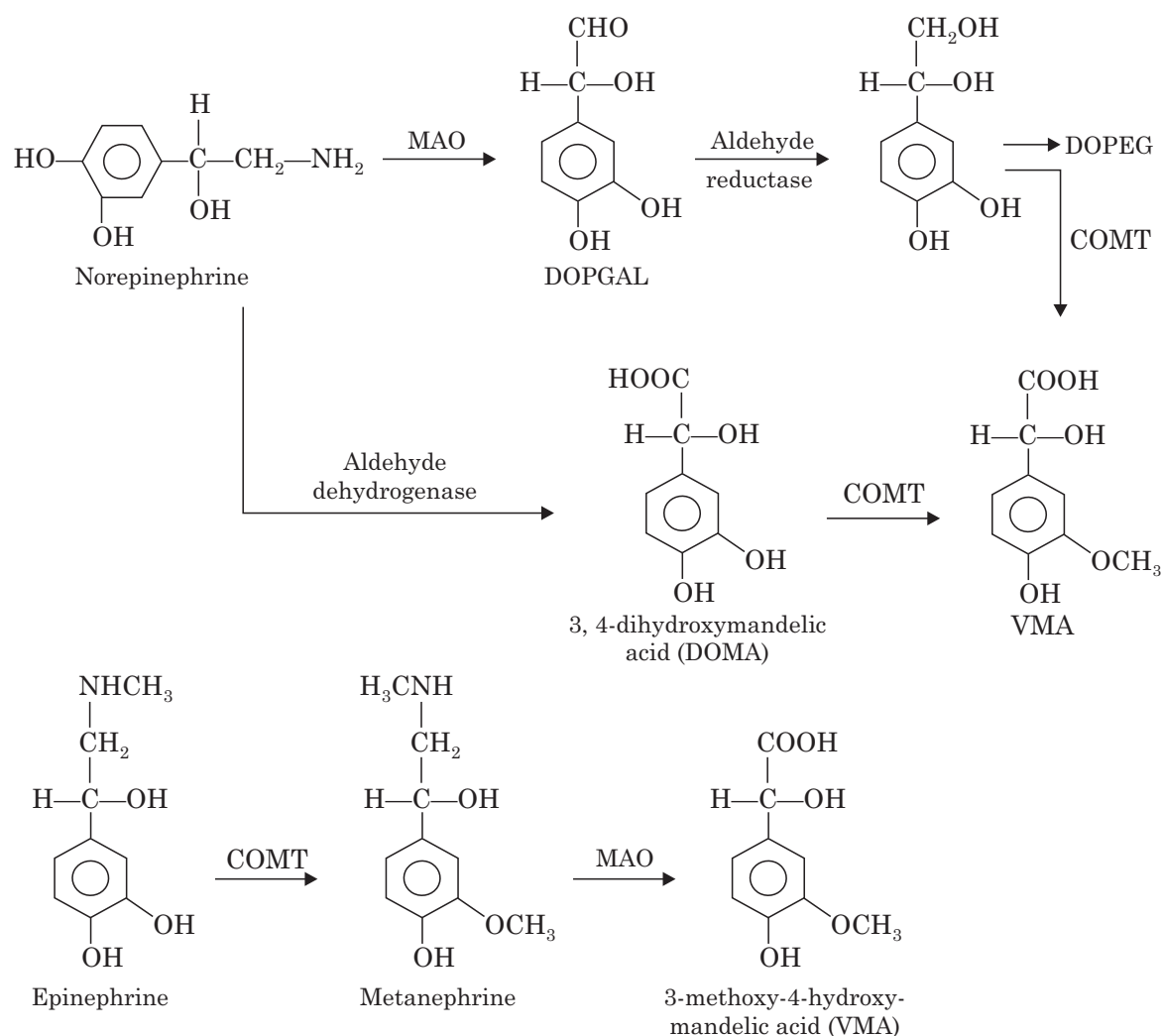

Metabolic pathways of catecholamines

ADRENERGIC RECEPTOR SITES

Adrenergic drugs exert their effects by direct action on adrenergic receptors. There are at least two adrenergic receptor sites (alpha (α) and beta (β)). Norepinephrine activates primarily alpha-receptors and epinephrine activates primarily beta receptors, although it may also activate alpha receptors. Stimulation of alpha receptors is associated with constriction of small blood vessels in the bronchial mucosa and relaxation of smooth muscles of the intestinal tract.

Beta receptor activation relaxes bronchial smooth muscles which cause the bronchi of the lungs to dilate.

In addition beta receptor stimulatory effects cause an increase in the rate and force of heart contractions. As a result increased amounts of blood leave the heart and is diverted from nonactive organs to areas that actively participate in the body's reaction to stress such as skeletal muscles, brain, and liver.

Alpha receptor site

Important features of alpha adrenergic receptor sites in order of preference are ;

1. **An anionic site.** The alpha-adrenergic receptor carries a negatively charged group (phosphate). The anionic site binds with the positive ammonium group.
2. One hydrogen bonding area
3. **A flat area.** A non-polar area for the aromatic ring binding.

The alpha receptors fall into two groups;

- (i) **α_1 -Adrenergic receptors.** They are found in the smooth muscles of iris, arteries, arterioles and veins.
- (ii) **α_2 -Adrenergic receptors.** They mediate the inhibition of adrenergic neurotransmitter release.

Beta receptor site

Important features of this receptor site are :

1. **An anionic site.** It is shown that an anionic negative acid group which binds with the positive ammonium group.
2. **Two hydrogen bonding areas.** It is shown as two serine with alcohol (OH) groups form hydrogen bonding with the phenolic—OH groups of the NE.

Tissue	Receptor subtype	Agonists	Antagonists
Heart	beta 1	NE, dobutamine, xamoterol	EP, atenolol, metoprolol
Adipose tissue	beta 1, beta 3		
Vascular smooth muscle	beta 2	EP, salbutamol, terbutaline, salmeterol	Butoxamine
Air way smooth muscle	beta 2	Terbutaline, salbutamol, salmeterol and zinterol	Butoxamine
Smooth muscle contraction	alpha 1	NE, EP, phenylephrine, oxymetazoline	Prazosin, doxazocin
Inhibition of transmitter release, hypotension, anaesthesia, vasoconstriction	alpha 2	Clenbuterol, alpha-methylnoradrenaline, dexmedetomidine, and mivazerol, clonidine	Yohimbine, idazoxan, atipamezole, efaroxan, and rauwolscine

3. **A flat area.** A non-polar area for the aromatic ring.

β -Adrenergic receptors are of three types. They are ;

- (i) **β_1 -Adrenergic receptors.** They are found in the myocardium where their stimulation increases the force and rate of myocardial contraction.
- (ii) **β_2 -Adrenergic receptors.** These are found in bronchial and vascular smooth muscles where their stimulation causes smooth muscle dilation or relaxation.
- (iii) **β_3 -Adrenergic receptors.** These receptors are expressed on fat cells and their stimulation causes lipolysis.

CLASSIFICATION OF ADRENERGIC AGONISTS

Adrenergic agonists are sub-divided into 3 classes; direct acting, indirect-acting and dual-acting agonists. These agents act on sympathetic nervous system, activates it.

1. Direct-acting agonists. They bind to and activate α_1 , α_2 , β_1 and β_2 receptors. Naturally occurring molecules which bind to these receptors include norepinephrine (NE; a neurotransmitter which binds to α_1 , α_2 and β_1 receptors), epinephrine (EP; a hormone produced in and secreted from the adrenal medulla which binds to $\alpha_1, \alpha_2, \beta_1$ and β_2 receptors — EP is a non-selective adrenergic agonist) and dopamine (DA; also a neurotransmitter which binds to DA receptors as well as α_1 , α_2 and β_1 receptors).

2. Indirect acting adrenergic agonists: They (*i.e.* amphetamines and cocaine) produce NE-like actions by stimulating NE release and preventing its re-uptake and thus its inactivation.

3. Dual-acting adrenergic agonists: These agents (*i.e.* ephedrine) act as a direct- and an indirect-adrenergic agonists (hence dual-acting). They bind to adrenergic receptors and stimulate NE release

CHEMISTRY AND STRUCTURE ACTIVITY RELATIONSHIPS OF ADRENERGIC DRUGS

1. The sympathomimetic drugs may be divided into catechol and non-catechol amines.
2. All catecholamines, possess the catechol nucleus (*o*-dihydroxybenzene)

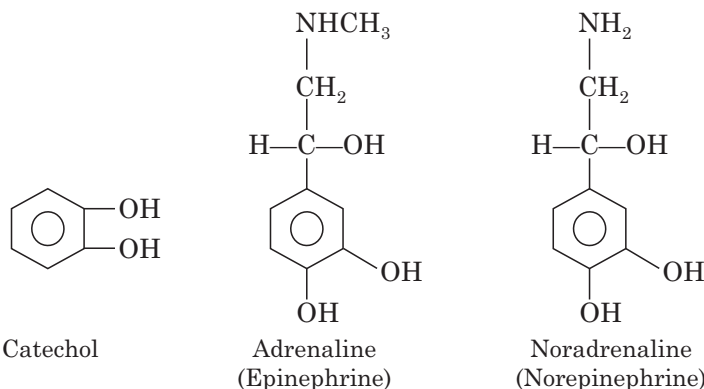

3. Noncatecholamines consisting of a benzene ring and an ethylamine side chain. β -phenylethylamine can be viewed as the parent compound, consisting of a benzene ring and an ethylamine side chain.

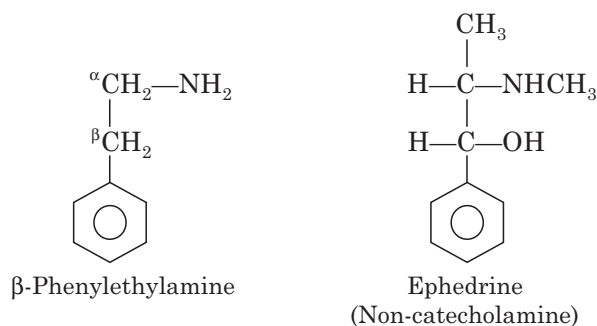

4. Separation of the aromatic ring and the amino group by two carbon atom shows the greatest activity.

5. Substitution on the amino group, increasing the size of the alkyl substituent increases β receptor activity, *e.g.* Isoproterenol.

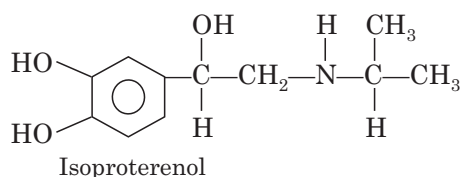

6. Substitution on the aromatic nucleus, specifically OH groups at the 3 and 4 positions of the ring are required for maximal α and β activity. When one or both of these groups is absent, without other aromatic substitution, the overall potency is reduced. Phenylephrine is thus less potent at both receptors than adrenaline, with β activity almost entirely absent.

7. Hydroxyl (—OH) groups at the 3 and 5 positions, in compounds with large amino substituents, confers β_2 selectivity, *e.g.* metaproterenol, terbutaline

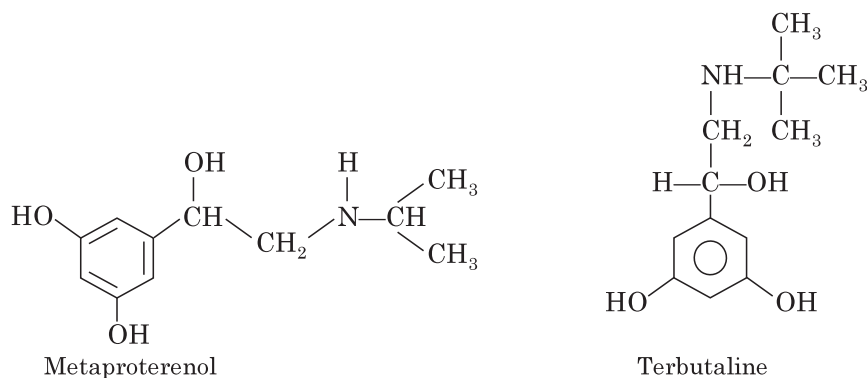

8. The response of non-catecholamines is largely determined by their ability to release NE, thus their effects are mainly on α and β_1

9. Phenylethylamines lacking both aromatic —OH groups and the β -OH on the ethyl chain produce almost all of their effects by NA release. Catecholamines have only a brief duration of action, and are ineffective orally, due to degradation by COMT. Agents lacking —OH substitution, especially the compounds with 3-OH, are resistant to COMT and have a longer duration of action and oral effectiveness

10. Substitution with groups other than —OH, in general, reduces α -adrenergic activity and almost abolishes β -adrenergic activity

11. Substitution on the β -C atom generally decreases central stimulant action, due to the lower lipid solubility of these agents. However, this also greatly enhances both α and β potency. Thus, ephedrine is less potent than methamphetamine as a CNS stimulant, but is more potent vasoconstrictor and bronchodilator. Absence of the benzene ring reduces the CNS stimulant action, without reducing peripheral effects, when replaced by a saturated, *e.g.* Cyclopentamine the proportion of α : β activity varies with the compound. However, the absence of benzene confers greater activity and many of these agents are used as nasal decongestants.

12. **Optical isomerism** is conferred by substitution on either of the ethyl carbon atoms

Laevorotatory. Substitution at the β -carbon atom produces naturally occurring NE and EP, both of which are over 10 times as potent as their isomers

Dextrorotatory. Substitution at the α -carbon atom generally confers greater potency in CNS stimulation, *e.g.* *d*-amphetamine

SPECIFIC ADRENERGIC DRUGS

A. Direct-acting agonists

Adrenaline (Epinephrine)

Chemistry. Adrenaline ($C_9H_{13}NO_3$) is a catecholamine and belongs to the family of biogenic amines. Chemically it is 1-(3,4-dihydroxyphenyl)-2-methylaminoethanol.

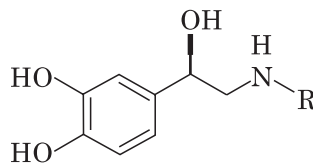

R = CH₃ ; Adrenaline

Epinephrine is prepared by Friedel Craft's acylation of catechol with chloroacetyl chloride to give α -haloacetophenone, followed by nucleophilic substitution with methylamine and catalytic reduction.

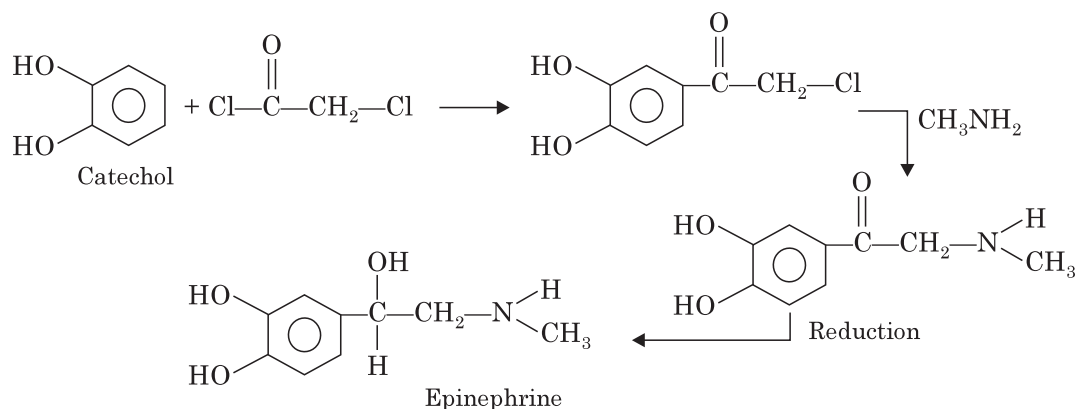

Adrenaline is available as adrenaline acid tartarate. Adrenaline is a white or creamy white crystalline and odorless powder. It is slightly soluble in water but freely soluble in mineral acids and alkali hydroxides. Adrenaline is insoluble in alcohol, ether and chloroform. It darkens slowly on exposure to air and light.

Adrenaline is a potent stimulator of both α and β receptors and, as such, its administration produces effects resembling generalized activation of the sympathetic nervous system particularly prominent are the actions on the heart and vascular smooth muscle. The occurrence of sweating, piloerection and mydriasis depend largely upon the physiological state of the subject.

Adrenaline is one of the most potent vasopressors known, given by IV route, it evokes a characteristic rise in blood pressure. The mechanism of the rise in blood pressure with adrenaline is;

1. Direct myocardial stimulation (positive *inotropic* effect)
2. An increased heart rate (positive *chronotropic* effect)
3. Peripheral vasoconstriction

Absorption, fate and excretion. Due to rapid oxidation and conjugation in the GIT mucosa and liver adrenaline is ineffective after oral administration. Absorption from subcutaneous tissues occurs slowly due to local vasoconstriction. Adrenaline is rapidly inactivated in the body, despite its stability in blood. The liver is rich in both COMT and MAO, however is not essential in the degradation process. The majority of an administered drug is excreted in the urine as metabolites.

Uses. The oral intake of adrenaline has no effect. Therefore it has to be administered parenterally. It is used as sympathomimetic (drugs which support the beating of the heart), broncholytic (drugs which relax the bronchial muscles) and antiasthmatic (drugs against asthma). It is also used to prevent bleedings during surgery or in the case of inner organ bleeding. Because adrenaline leads to constriction of blood vessels, it is administered in combination with local anesthetics. In this combination, anesthetics have a longer lasting effect and can be administered in smaller doses.

Noradrenaline (Norepinephrine)

Chemistry. Norepinephrine, or *l*-β-[3,4-dihydroxyphenyl]-α-methyl-aminoethanol is the chemical mediator liberated at mammalian post-ganglionic adrenergic nerve terminals. Noradrenaline is available as acid tartarate salt. It is available as odorless, bitter taste, white crystalline powder. It is soluble in water and slightly soluble in alcohol. Noradrenaline should be protected from air and light as it darkens on exposure to air and light.

It differs from adrenaline only by lacking the methyl substitution on the aminoethanol and, as for adrenaline, the *l*-isomer is pharmacologically active. Noradrenaline constitutes 10-20% of the catecholamine content of the adrenal medulla and as much as 97% in some pheochromocytomas. Norepinephrine bitartrate is a water soluble, crystalline monohydrate salt, which, like adrenaline, it is readily oxidised. It is available for injection as 0.2% bitartrate, which is equivalent to noradrenaline 0.1%. It is usually given as a central i.v. infusion at a concentration of 60 µg/ml.

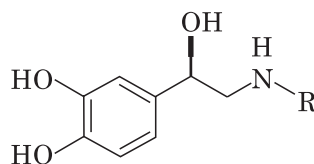

R = H ; Noradrenaline

Pharmacological actions. Both adrenaline and noradrenaline are approximately equipotent at cardiac β₁ receptors. Noradrenaline is a potent agonist for α-receptors but has little action on β₂ receptors. However, noradrenaline is somewhat less potent than adrenaline at most α-receptors.

Dopamine

Chemistry. Dopamine (3,4-dihydroxyphenylethylamine), differs from the other naturally occurring catecholamines, lacking the β-OH group on the ethylamine side chain. It is the metabolic precursor of noradrenaline and adrenaline and is a central neurotransmitter.

Pharmacology. Dopamine is a substrate for both MAO and COMT and is thus ineffective orally. It has minimal effects on the CNS, not crossing the blood brain barrier. Dopamine exerts a positive inotropic effect on the heart, acting at β₁ receptors. Dopamine usually increases the systolic and pulse pressures.

Dosage and administration. Dopamine hydrochloride is a water soluble, crystalline, light and alkali sensitive white powder marketed in solutions of 40, 80 and 160 mg/ml. Dopamine is effective only by i.v. infusion, when it is usually diluted to 0.8 to 1.6 mg/ml. The usual adult dose is 2-5 µg/kg/min.

Uses. Acute congestive cardiac failure with imminent renal failure, septic shock, cardiogenic shock, surgical shock, acute pancreatitis.

ISOPROTERENOL (ISOPRENALINE)

Chemistry. Isoproterenol, or dl-β-[3,4-dihydroxyphenyl]-α-isopropylaminoethanol, is a synthetic catecholamine acting almost exclusively at β receptors.

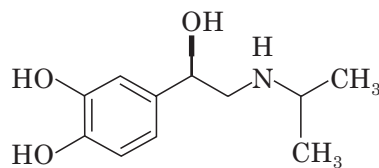

Isoproterenol

Due to the absence of α adrenergic effects, isoproterenol produces most of its effects in the heart and the smooth muscle of the bronchi, skeletal muscle vasculature, and the GIT in addition, it produces marked metabolic effects in adipose tissue, skeletal muscles and in the liver in some species.

Isoproterenol is available for injection as the water-soluble hydrochloride salt. It is available as a solution for inhalation, 0.25% to 1%, usually diluted 1:5 with normal saline. It is synthesized by following method :

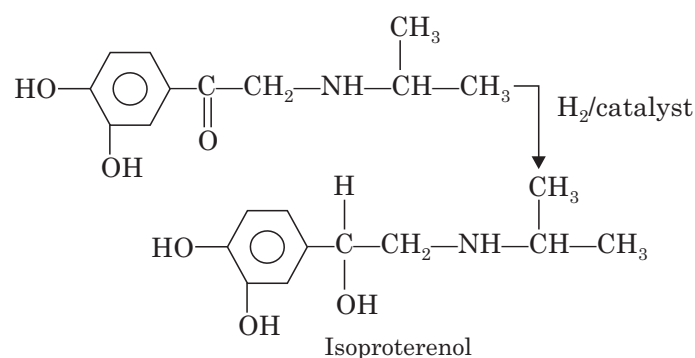
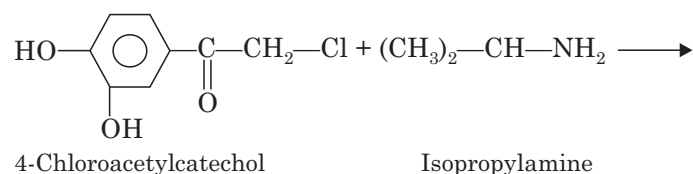

Phenylephrine

Chemistry. Chemically it is 1-(3-hydroxyphenyl)-2-methylaminoethanol. Phenylephrine differs from adrenaline only by lacking the 4-OH group on the benzene ring and subsequently is resistant to COMT and has predominantly α -agonist effects.

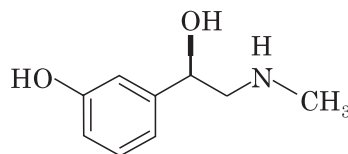

Phenylephrine

Phenylephrine is prepared by condensation of 3-chloroacetylphenol with methylamine followed by catalytic reduction.

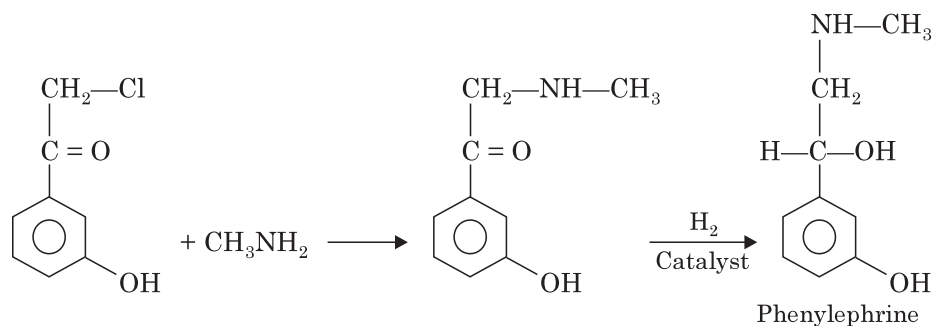

Properties. Phenylephrine is available as hydrochloride salt. It is white, odorless, bitter taste, crystalline powder. It is soluble in water, alcohol, and glycerol. It should be stored in airtight container to protect from light because it is decomposed by light.

Uses. Phenylephrine is a selective α_1 -receptor agonist. Oral absorption is not reliable and so it is given parenterally or topically as eye or nasal drops. phenylephrine predominantly acts on peripheral arterioles results in a rise in systolic and diastolic pressures accompanied by a marked reflex bradycardia. Phenylephrine is used as a nasal decongestant, mydriatic and as a vasopressor agent.

Dobutamine

Chemistry. Dobutamine is a synthetic catecholamine derivative. It resembles dopamine chemically, but possesses a bulky aromatic residue on the amino group despite the absence of a β -OH group. Dobutamine is a racemic mixture of two enantiomeric forms. The (+) isomer has potent β -agonistic actions. The (-) isomer has potent α_1 -agonistic and poor β -agonistic actions.

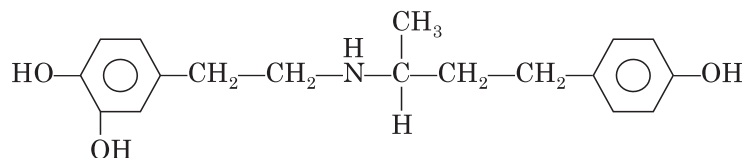

Properties. Dobutamine is a white color, sparingly water soluble powder. It is a *selective* β_1 -receptor agonist and has only slight indirect actions. It increases cardiac output without any effect on heart rate and blood pressure. It may activate α_1 -receptor in higher dose.

Uses. Dobutamine is used in patients of heart failure associated with myocardial infarction, open heart surgery and cardiomyopathy.

SELECTIVE β_2 -ADRENERGIC STIMULANTS

Because of their relative selectivity, these agents relax the smooth muscle of the bronchi, uterus and blood vessels. Generally they have far less action on the heart than isoproterenol and other agents. Increased β_2 -agonist activity is conferred by the substitution of increasing bulky lipophilic groups on the amino group of isoproterenol.

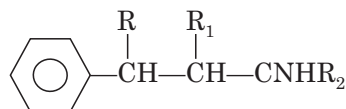
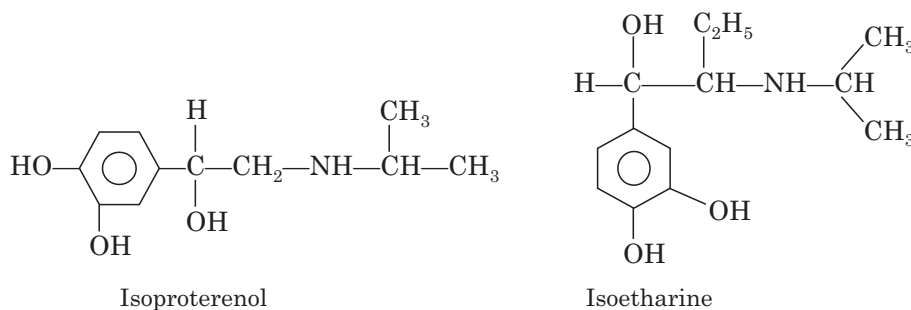
General structure for β_2 -adrenergic stimulants

Isoproterenol

Isoetharine

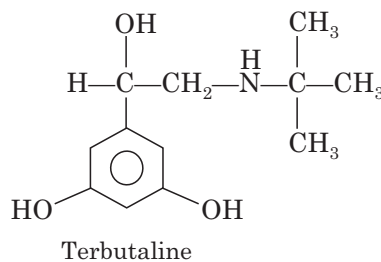

Terbutaline

Changing the hydroxyl group ($-\text{OH}$) substitutions on phenyl group of isoproterenol from 3, 4 to 3, 5 results in metaproterenol, which retains its β_2 -agonistic actions but has reduced β_1 -agonistic activity. Further the shift of the $-\text{OH}$ group produces resistance to MAO and prolongs the duration of action. Such agents include,

- | | |
|----------------|--------------------|
| (a) Salbutamol | (b) Terbutaline |
| (c) Ritodrine | (d) Metaproterenol |
| (e) Nylidrin | (f) Isoetharine. |

Most of these drugs are administered orally or by inhalation.

Terbutaline

Chemistry. Terbutaline is a non-catecholamine, therefore is resistant to COMT. Chemically terbutaline is N-tert-butyl-N-[2-(3,5-dihydroxyphenyl)-2-hydroxymethyl] amine which is available as sulphate salt.

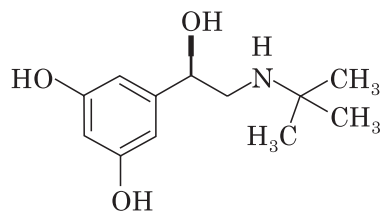
Terbutaline (β_2 -selective)

Terbutaline is prepared by reduction of 2-(tert-butylamino)-3',5'-dihydroxyacetophenone by catalytic hydrogenation :

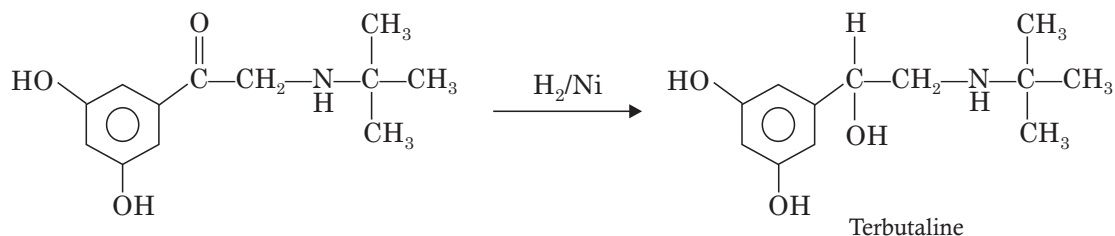

Properties. Terbutaline is a white, odorless, bitter taste crystalline powder. It is soluble in water, slightly soluble in alcohol and practically insoluble in ether and chloroform. It should be protected from light.

Isoetharine. Isoetharine is 3,4-dihydroxy- α -[1-(isopropylamino)propyl]benzyl alcohol. It is available as its methane sulphonate salt. It occurs as white, odorless, bitter taste, water soluble solid.

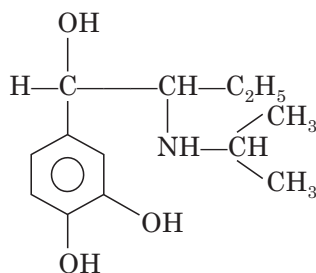

Uses. Isoetharine has β_2 -agonistic properties and is used as a bronchodilator.

Nylidrin

Nylidrin occurs as hydrochloride. It is sparingly soluble in water and slightly soluble in alcohol. Practically insoluble in ether, chloroform and benzene.

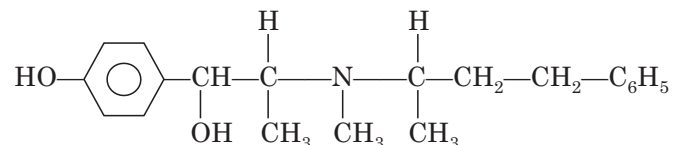

Nylidrin is synthesized from *p*-hydroxyephedrine by following steps ;

1. *p*-Hydroxyephedrine is condensed with 4-phenyl-2-butanone to get schiff base.

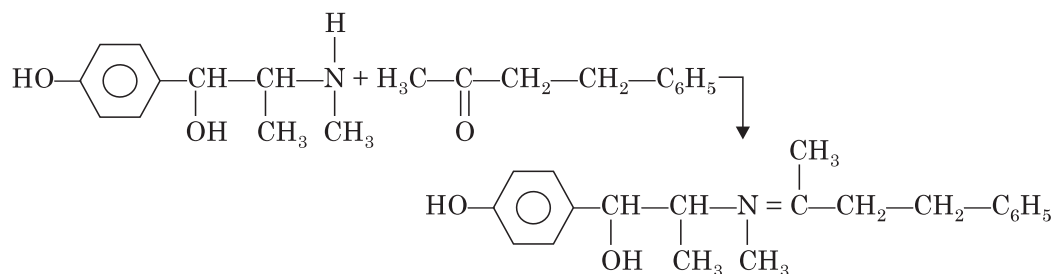

2. The schiff base is reduced to yield Nyldrin

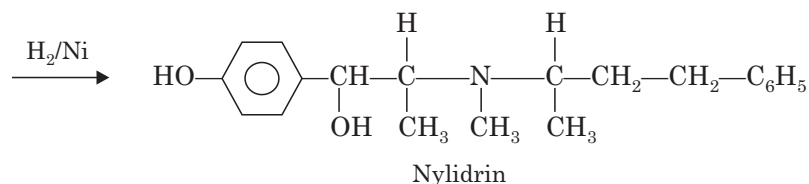

Uses. Vasodilator (peripheral).

Ritodrine

Ritodrine occurs as Ritodrine hydrochloride. Ritodrine hydrochloride is water soluble, odorless, white colored crystalline compound.

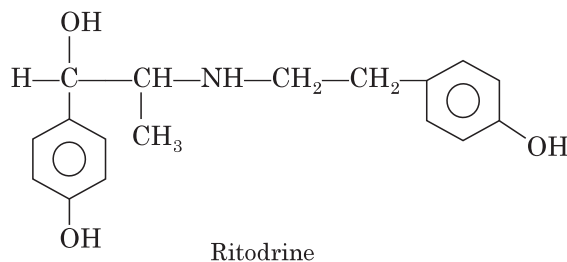

Uses. Ritodrine is a short acting β_2 -stimulant and is used parenterally for delaying premature delivery of foetus.

Metaproterenol

Metaproterenol occurs as sulphate salt. It is odorless, bitter taste, water-soluble crystalline solid. It is photosensitive compound hence should be protected from light and air.

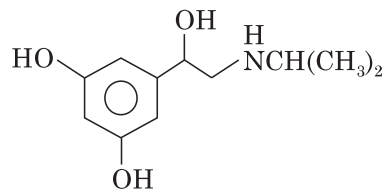

Uses. Metaproterenol possesses strong β_2 -agonistic properties. It is used in the treatment of bronchial asthma.

SELECTIVE α -ADRENERGIC STIMULANTS

Some adrenergic drugs have selective action on α -adrenergic receptors. Ex: Phenylephrine and methoxamine.

Methoxamine

Methoxamine is available as hydrochloride. It is white, crystalline, odorless, water soluble solid.

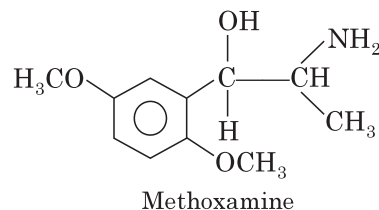

Methoxamine is a parenteral vasopressor and selective for α_1 -receptors and so have few cardiac stimulatory properties. Because it is not substrate for COMT, its duration of action is significantly longer than that of norepinephrine, but primary use is limited to treat hypotension during surgery or shock.

Uses. Methoxamine is also used to treat supraventricular tachycardia.

INDIRECTLY ACTING ADRENERGIC DRUGS

This class is comprised of non-catecholamines. Most of these drugs retain phenylethylamine skeleton.

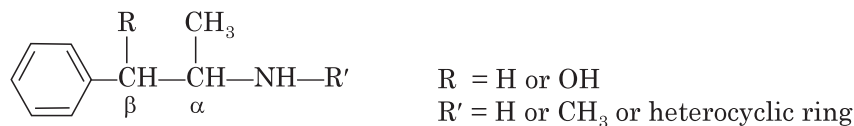

These compounds are resistant to COMT and MAO enzymes due to lack of phenolic hydroxyl groups and presence of α -methyl groups. These compounds pass more readily through blood brain barrier because of increased lipophilicity.

Amphetamine

Chemistry. Amphetamine is an indirect-acting sympathomimetic amine and its action depends on the release of norepinephrine from adrenergic nerves. It is synthesized by reductive amination of phenylacetone with ammonia and hydrogen.

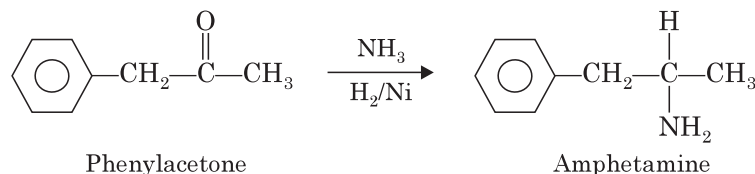

Properties. Amphetamine is bitter taste, slightly water miscible, mobile liquid. Amphetamine occurs as sulphate salt, which is slightly bitter taste, water soluble solid.

Uses. Amphetamine is one of the most potent sympathomimetic. CNS stimulant effects are thought to be due to stimulation of the cortex. The d-isomer is 3-4 times more potent than the l-isomer. Amphetamine causes increased wakefulness, elevated mood, increased initiative, self-confidence and ability to concentrate. In addition to these effects it also has an anorexic action and can be used in the treatment of obesity.

Hydroxyamphetamine

Hydroxyamphetamine occurs as hydrobromide salt. Hydroxyamphetamine hydrobromide is water soluble, white crystalline compound.

Hydroxyamphetamine is synthesized by reducing *p*-methoxybenzyl methyl ketoxime followed by hydrolysis of methoxy group with HI.

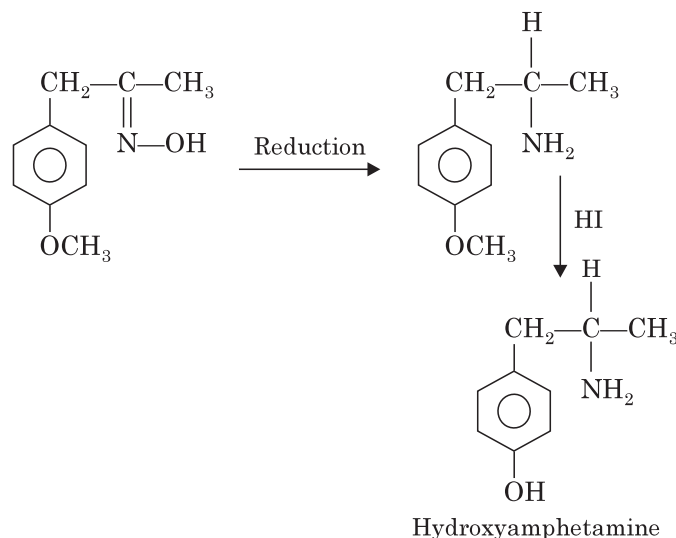

Hydroxyamphetamine possesses α -receptor stimulant activity but lacks CNS activity. It is a powerful vasoconstrictor.

Uses. Hydroxyamphetamine is used in the following conditions ;

- (a) Narcolepsy (sudden attack of sleep in completely inappropriate situations)
- (b) Hyperkinetic syndrome in children
- (c) As an anorexiant in the treatment of obesity

Propylhexedrine

Propylhexedrine is 1-cyclohexyl-2-methylaminopropane, which occurs as racemic mixture. Propylhexedrine is prepared from methamphetamine by reduction.

Properties. It is an oily liquid having amine odor and boils at 205°C. It is slightly soluble in water and miscible with alcohol, chloroform, and ether.

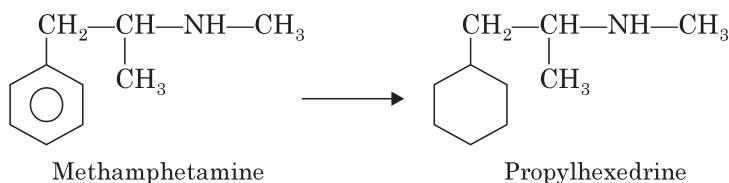

Uses. Propylhexedrine is used as 1) Nasal decongestant 2) adrenergic agent (vasoconstrictor)

Cyclopentamine

Cyclopentamine is a non-catecholamine possessing indirectly acting adrenergic agonistic activity.

Cyclopentamine is prepared from cyclopentanone by following sequential steps :

(a) Cyclopentanone is condensed with cyanoacetic acid by Knoevenagel reaction, followed by decarboxylation to get an unsaturated nitrile.

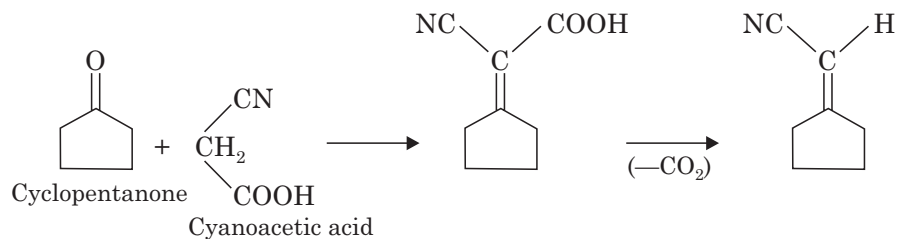

(b) The unsaturated nitrile is reduced to get 2-cyclopentylmethyl nitrile

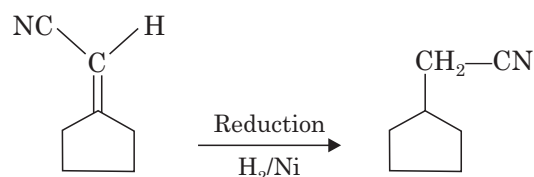

(c) 2-cyclopentyl methyl nitrile is allowed to react with methyl magnesium bromide to afford a methyl ketone which on reductive amination with methylamine yields cyclopentamine.

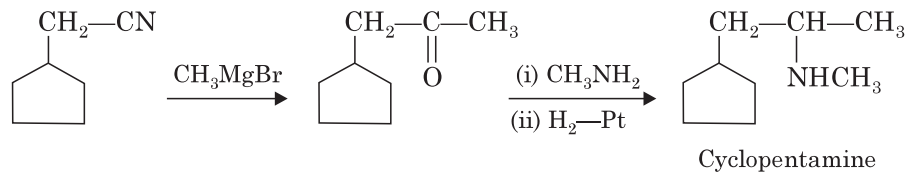

Naphazoline

Naphazoline is 2-(1-naphthylmethyl)-2-imidazoline. It is prepared by strong heating of 1-naphthaleneacetonitrile with ethylenediamine monochloride at 200°C.

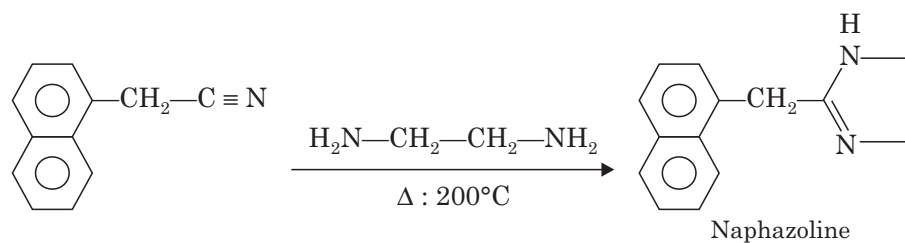
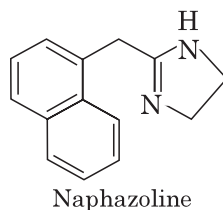

Uses. Naphazoline is direct acting sympathomimetic drug, which has only α -agonistic activity. It is used topically as nasal decongestant.

Tetrahydrozoline

Tetrahydrozoline occurs as hydrochloride.

Properties. It is freely soluble in water, and alcohol but very slightly soluble in chloroform and practically insoluble in ether. It melts at 256°C.

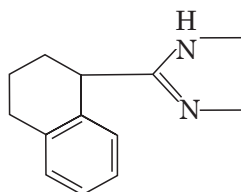

Tetrahydrozoline is prepared by the following reaction :

1. 4-Keto-1, 2, 3, 4-tetrahydro-1-naphthoic acid amide is reduced by catalytic hydrogenation followed by condensation with ethylenediamine yields tetrahydrozoline.

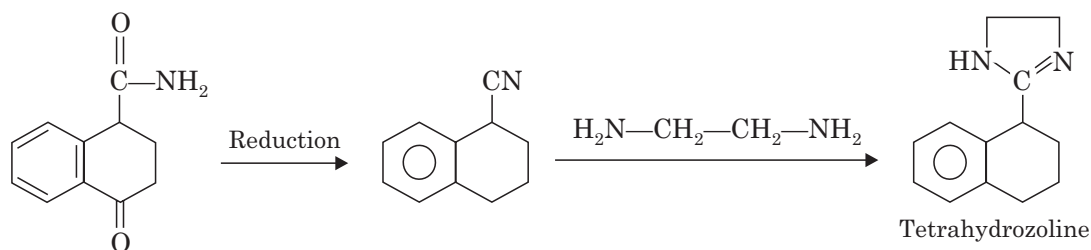

Uses. 1. Adrenergic (vasoconstrictor) ; 2. Nasal decongestant.

Xylometazoline

Xylometazoline occurs as hydrochloride which is 2-(4-*tert*-butyl)-2,6-dimethylbenzyl)-2-imidazoline.

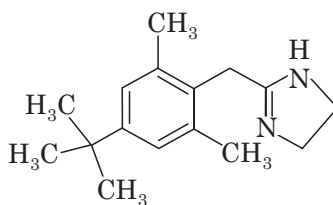

It is prepared by strong heating of (4-*tert*-butyl)-2,6-dimethylphenyl acetonitrile with ethylenediamine monochloride at 200°C.

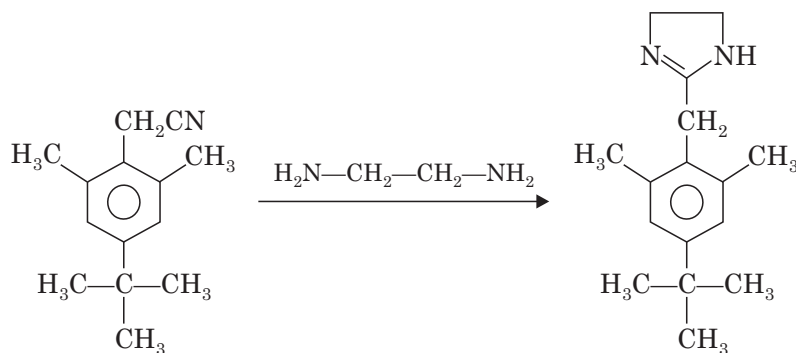

Uses. Xylometazoline is a sympathomimetic decongestant. It is a sympathomimetic with marked alpha-adrenergic action. It acts as a vasoconstrictor when applied topically to mucus membrane and thus reduces swelling and congestion.

Oxymetazoline

Oxymetazoline occurs as hydrochloride which is 6-tert-butyl-3-(2-imidazolin-2-ylmethyl)-2,4-dimethylphenolmonohydrochloride.

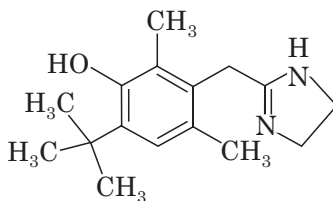

Uses. Oxymetazoline is direct acting sympathomimetic drug. It is used topically as nasal decongestant.

ADRENERGIC DRUGS WITH MIXED ACTION

These drugs act both directly with the receptor sites and partly by the release of endogenous norepinephrine.

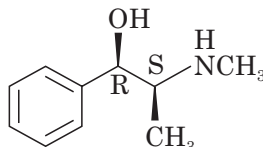

Ephedrine

Ephedrine

Introduction. Occurs naturally in many plants, being the principal alkaloid of *Ma Huang* which has been used in China for over 2000 years. It has agonist activity at both α and β -receptors. It contains two asymmetric carbon atoms, four compounds are available only racemic and L-ephedrine is clinically in use. Ephedrine differs from adrenaline mainly by its,

1. effectiveness after oral administration
2. longer duration of action
3. more pronounced central actions
4. much lower potency

It produces a sharp rise in systolic, diastolic and pulse pressures, with a reflex bradycardia, similar to adrenaline but lasting for 10 times as long.

Structural elucidation of ephedrine

- (i) The molecular formula of ephedrine is $C_{10}H_{15}NO$.
- (ii) **Basic structure.** Ephedrine on oxidation gives benzoic acid. Therefore the structure of ephedrine contains a benzene ring with only one side chain.

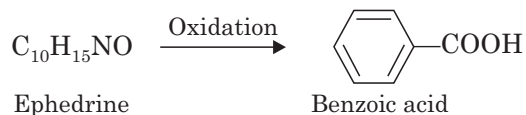

- (iii) **Nature of nitrogen.** Ephedrine on reaction with nitrous acid gives N-nitrosoamine hence nitrogen atom in ephedrine is 2° amine.

(iv) **Nature of Oxygen.** Ephedrine on reaction with benzoyl chloride gives dibenzoyl derivative. This shows that ephedrine contains one hydroxyl group.

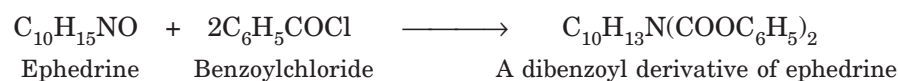

(v) **Hydramine fission.** Ephedrine on heating with hydrochloric acid gives methylamine and propiophenone. These products are formed by hydramine fission of ephedrine.

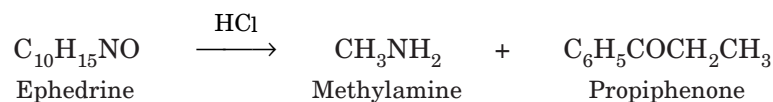

(vi) The following structure was proposed for ephedrine which was able to undergo hydramine fission

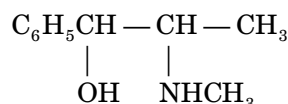

Proposed structure of ephedrine

(vii) **Evidence for proposed structure.** The above proposed structure yield 1, 2-methylphenyl ethylene oxide on Hofmann's exhaustive methylation method :

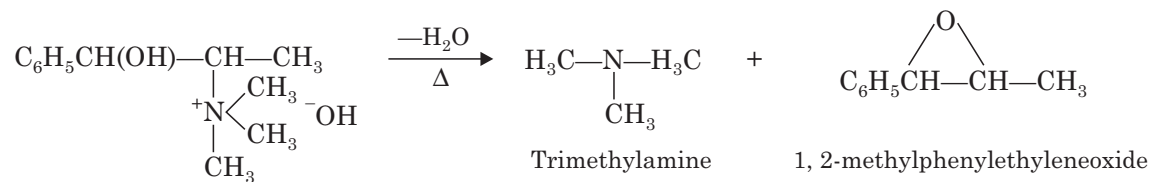

Quaternary ammonium
hydroxide of ephedrine

(viii) **Stereochemistry.** The proposed structure contains two chiral centres, hence even after the removal of hydroxyl group by a hydrogen atom the obtained product is optically active. The naturally available ephedrine too is optically active. The naturally isolated ephedrine [(-) ephedrine] gives deoxy ephedrine (by replacement of —OH group by hydrogen atom), which is still optically active. Since ephedrine molecule contains two dissimilar chiral centres hence 4 optically active isomers are possible.

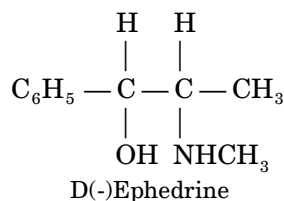

Uses. Ephedrine is mainly used as a bronchodilator in asthma. It is used to treat narcolepsy and depressive state. It is also used as nasal decongestant, mydriatic and in certain allergic disorders.

Metaraminol

Chemistry. Chemically metaraminol is 3-hydroxyphenylisopropanolamine. Metaraminol is an isomer of phenylephrine.

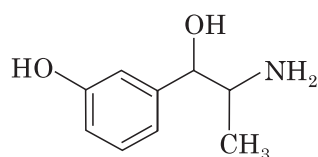

1R, 2S-Metaraminol

Metaraminol is synthesized from m-hydroxy benzaldehyde by a selective condensation with nitroethane using tetrabutylammonium fluoride in tetrahydrofuran as a catalyst, followed by a reduction with Raney nickel in formic acid.

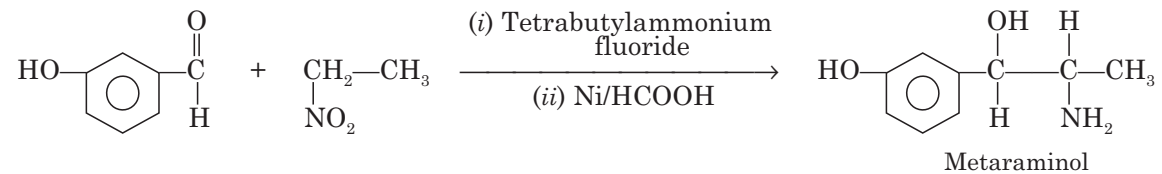

Metaraminol

Uses. Metaraminol is used for its pressor action for maintaining blood pressure during anesthesia, haemorrhage and other hypotensive states.

Mephentermine

Mephentermine is another general adrenergic agonist with both direct and indirect activity. Mephentermine's therapeutic utility is as a parenteral vasopressor used to treat hypotension induced by spinal anesthesia or other drugs.

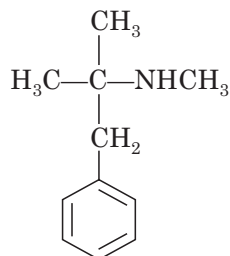

12

Adrenoreceptor Blocking Agents

These agents competitively antagonise the effects of the catecholamines at α and/or β -adrenergic receptors. Since the sympathetic nervous system is intimately involved in the modulation of a large number of homeostatic mechanisms, interference with its function impairs the capacity of the organism to generate appropriate physiological responses to provocative or adverse environmental conditions. Thus, many of the side effects of these agents are postural hypotension, sedation or depression, increased GIT motility, diarrhoea, impaired ability to ejaculate, increased blood volume and sodium retention.

β -ADRENERGIC BLOCKING AGENTS

All of the available agents competitively block the effects of endogenous and exogenous catecholamines. These drugs slow the heart rate (chronotropic) and decrease the force of contraction (inotropic) (β_1 -effect). They also block the sympathetic stimulation of kidney renin release (β_2 -effect).

β -Blockers are classified into the following chemical classes based on their structures ;

1. **Arylethanolamines.** *Ex:* Dichloroisoproterenol, pronethalol.
2. **Aryloxypropanolamines.** *Ex:* Propranolol, nodolol, practolol, metoprolol, 4-hydroxypropranolol.

β -Blockers are structurally similar to β -agonists. The catechol ring can be replaced by a variety of ring systems without loss of antagonistic activity. The following are essential requirements for β -blockers;

1. Replacement of catechol hydroxyl ($-\text{OH}$) groups with chlorine (Cl) or phenyl ring system retains β -blocking activity.

Ex: Dichloroisoproterenol, Pronethalol.

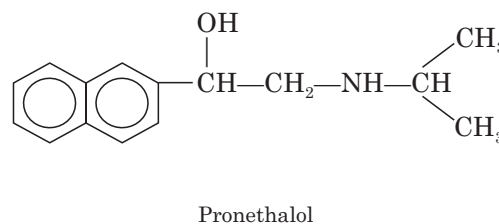
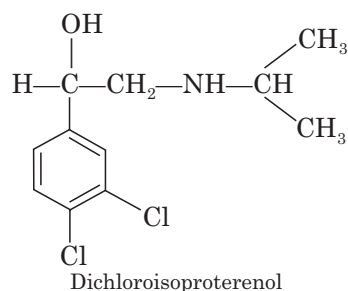

2. N, N-Disubstitution decreases β -blocking activity. Activity is maintained when phenylethyl, hydroxyphenyl ethyl or methoxyphenylethyl groups are added to amine part of the molecule.

3. The two-carbon side-chain is essential for activity.

4. Incorporation of $-\text{OCH}_2-$ group into the molecule between the aromatic ring and the ethylamine side chain provides β -blocking agents. Ex: propranolol.

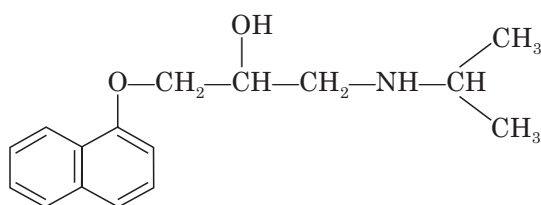

5. β_1 -Selective antagonists are obtained by the introduction of para substituents on the aromatic ring along with the absence of meta-substituents. Ex: practolol.

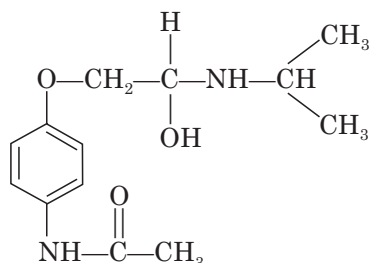

6. Nitrogen atom should be of secondary amine for optimum β -blocking activity. Generally bulky alkyl groups (tert-butyl or isopropyl) are found on the amino group.

7. **Setereoisomerism.** β -Blockers exhibits a high degree of stereoselectivity in the production of their β -blocking effects. The carbon of side chain bearing hydroxyl group must be (s)-configuration for optimal affinity to the β -receptor.

Ex: Levobunolol, Timolol.

Aryloxypropanolamines. There are four size.

Propranolol. Propranolol is 1-(isopropylamino)-3-(1-naphthyl)-2-propanol. Black and co-workers discovered propranolol, which is a structural relative to pronethalol. The levo isomer is 100 times more active than dextro isomer. First pass effect is substantial and 4-OH metabolite is active. Propranolol is a mixed β -blocker. S-isomer is most active.

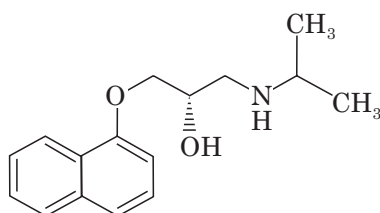

Propranolol is a secondary amine. It is available as hydrochloride salt. Propranolol hydrochloride is colorless, water soluble solid. It is prepared by the following chemical reactions.

α -Naphthol on reaction with epichlorhydrin provides the glycidic ether which on treatment with isopropyl amine gives propranolol.

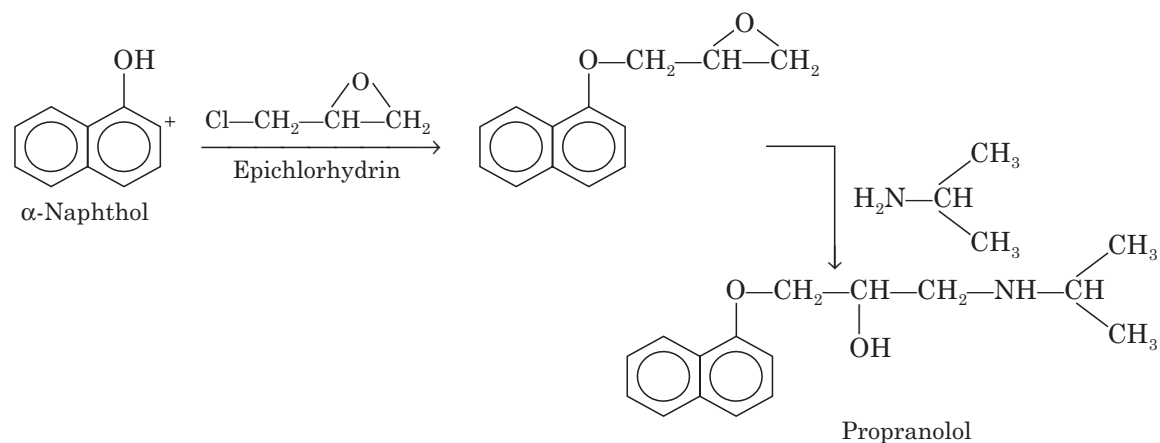

- Uses:**
- Propranolol is an effective antihypertensive agent
 - It is also used to treat arrhythmias
 - Propranolol potentiates the activity of hypoglycemic agents

HydroxyPropranolol. 4-Hydroxypropranolol is a short acting β -antagonist. It also possess some intrinsic sympathomimetic activity.

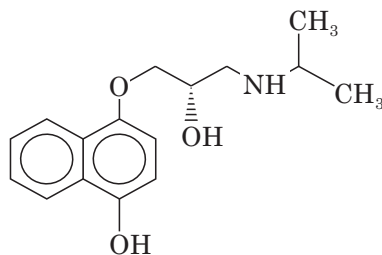

Timolol. Timolol is (S)-1-((t-butylamino)-3-(4-morpholino-1, 2, 5-thiadiazol-3-yloxy)-2-propanol. It has been approved for hypertension and prolonging post-myocardial infarction. Timolol is a selective β -blocker, acts on β_1 -adrenergic receptors.

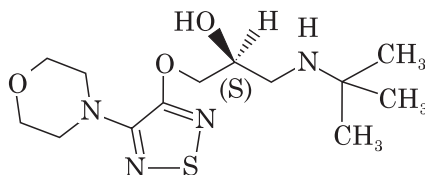

Metoprolol. Metoprolol is 1-(4-(2-methoxyethyl)phenoxy)-3-((1-methylethyl) amino)-2-propanol. It is moderately lipid soluble. Metoprolol is β_1 -selective antagonist.

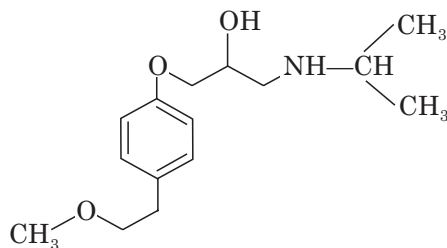

Atenolol. Atenolol is 1-*p*-amidomethylphenoxy-3-isopropylamino-2-propanol. It has significantly fewer CNS side effects compared to propranolol. Atenolol is hydrophilic β_1 -selective antagonist

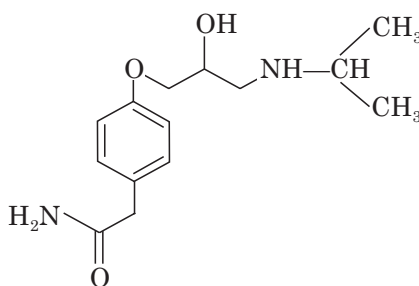

Dichloroisoproterenol. Dichloroisoproterenol, the first β -adrenoreceptor blocking agent. It inhibits both, the relaxation of bronchial smooth muscle and cardiac stimulant actions of isoprenaline.

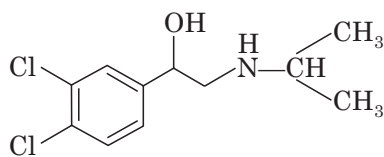

Pronethalol. Pronethalol is a better β -blocker than dichloroisoproterenol. Pronethalol is synthesized from 2-acetylnaphthalene by the following steps:

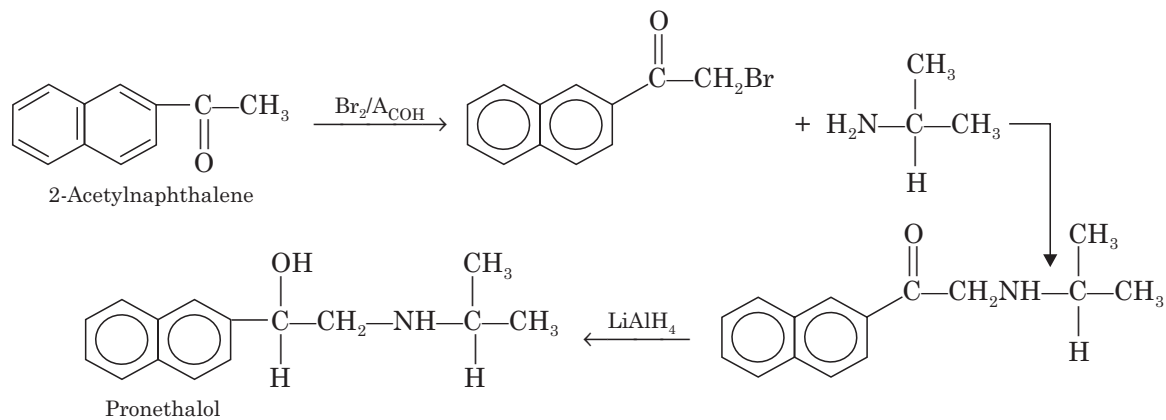

Butoxamine. Butoxamine is a selective β -adrenoreceptor blocking agent. Butoxamine is synthesized from 1, 4-dimethoxybenzene as follows:

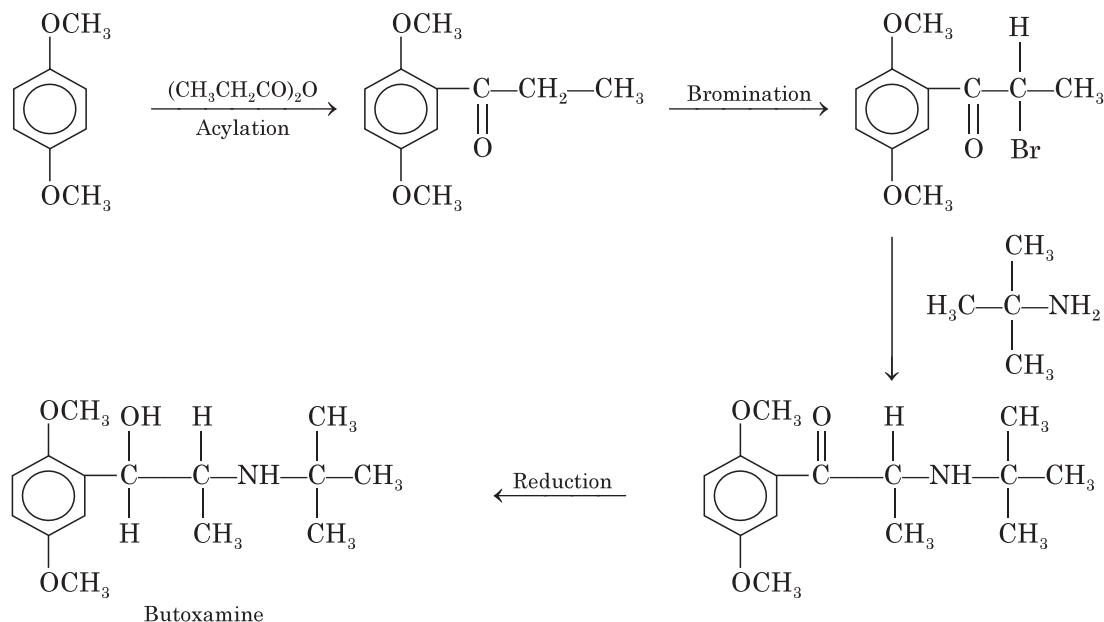

Butoxamine blocks β_2 -receptors in uterine and bronchial smooth muscles and in skeletal muscles. Presently it has been used as a research tool but it doesn't have any clinical use.

Labetalol. Labetalol is a competitive antagonist at α_1 - and non-selective β -receptor blocking agent. It is optically active, as its structure possesses two optically active centres. Labetalol is used as an antihypertensive agent.

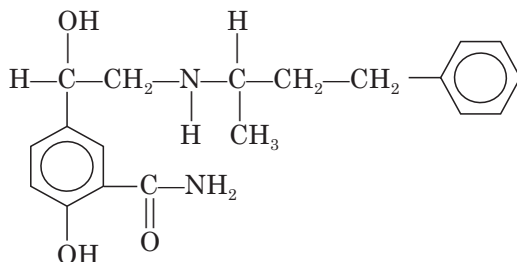

Therapeutic uses of the β -blockers:

(a) **Hypertension.** β -Blockers are often combined with a diuretic agent, or a vasodilator, but are frequently effective alone not associated with postural or exercise induced hypotension and seldom disturbs sexual function.

(b) **Coronary artery disease.** β -blockers were originally developed for the treatment of angina pectoris.

(c) **Arrhythmias.** The value of these agents relates to their ability to slow the SA node, and to decrease atrial and AV nodal conduction.

(d) **Dissecting aortic aneurysm.** The main aim of treatment is to reduce BP and the wall shear stress.

(e) **Glaucoma.** These agents lower intraocular pressure in open angle glaucoma, because of its lack of local anesthetic (membrane stabilising) effects, timolol, is used topically.

α -ADRENERGIC BLOCKING AGENTS

The α -receptor blockers in most cases do not show selectivity of action. Thus α -blockers have limited clinical use. α -blockers have been employed as antihypertensives for decades. These agents enjoy wide structural variations. On the chemical basis, various α -receptor blockers can be classified as:

- (i) Ergot alkaloids (ii) Imidazolines (iii) β -Haloalkylamines
(iv) Quinazolines (v) Miscellaneous agents.

ERGOT ALKALOIDS. Ergot is the compact mycelium of a fungus *Claviceps purpurea*, which can infect rye, and was responsible for outbreaks of poisoning due to consumption of infected grain which resulted in ergotism (characterized by dry gangrene of limbs and CNS symptoms). Ergot alkaloids are derivatives of lysergic acid which affect adrenoreceptors, DA and 5-HT receptors. *Ex:* Ergotamine, Ergotoxine, Ergonovine.

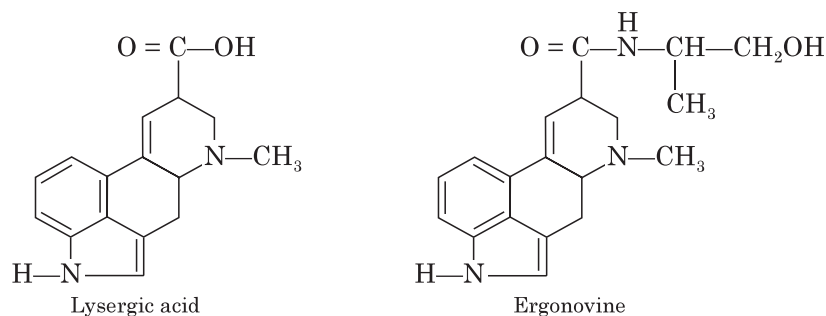

The semisynthetic derivatives have no action on uterus and possess α -agonistic and vasoconstrictor actions. *Ex:* Dihydro ergotamine.

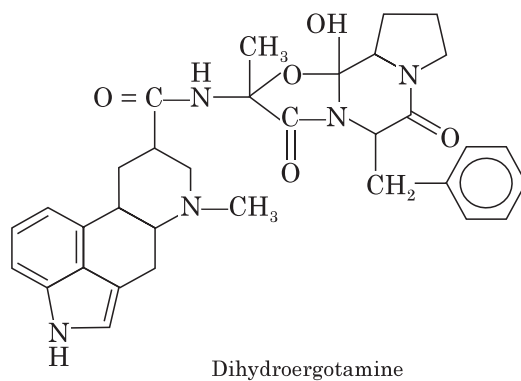

QUINAZOLINES. They are selective α_1 -adrenergic competitive blockers.

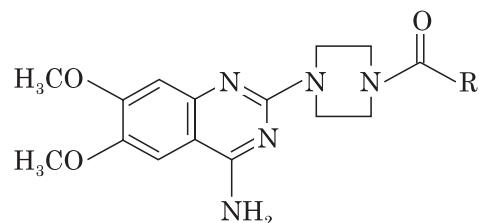

1. These drugs possess quinazoline, piperazine and acyl moieties. *Ex:* Prazosin, Terazosin, doxazosin.
2. The 4-amino group on the quinazoline ring is essential for α_1 -receptor antagonistic-activity.
3. At 2nd position of quinazoline nucleus any heterocyclic moiety (piperazine or piperidine) retains α_1 -receptor binding activity. *Ex:* Prazosin, terazosin

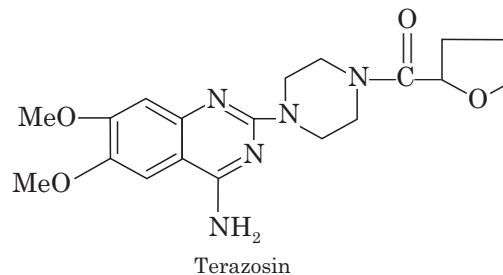
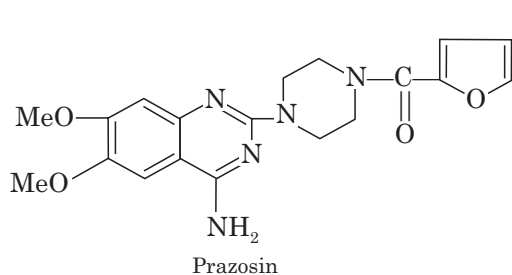

4. Acyl groups have profound effect on pharmacokinetic properties.

Prazosin. Prazosin, the first known selective α_1 -blocker, was discovered in the late 1960s. It is far more potent α_1 -receptor blocker. Prazosin is 1-(4-amino-6,7-dimethoxy-2-quinazolinyl)-4-(2-furanylcarbonyl) piperazine.

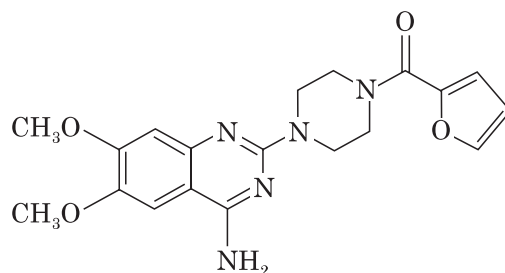

Uses. Prazosin blocks the postsynaptic α_1 -adrenoreceptors causing vasodilation and reduction in blood pressure. Prazosin is used to treat all grades of hypertension.

IMIDAZOLINES

They have competitive (reversible) α -antagonistic activity. Imidazolines are structurally similar to imidazoline α -agonists (naphazoline, xylometazoline).

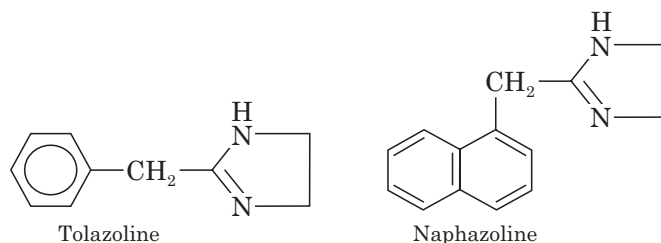

Naphazoline, oxymetazoline, tetrahydrozoline and xylometazoline are selective α_1 -agonists and thus are vasoconstrictors. They all contain a one-carbon bridge between C-2 of the imidazoline ring and a phenyl substituent, thus, the general skeleton of a phenylethylamine is contained within the structures. Lipophilic substitution on the phenyl ring *ortho* to the methylene bridge appears to be required for agonist activity at both types of α -receptors. Bulky lipophilic groups attached to the phenyl ring at the *meta* or *para* positions provide selectivity for the α_1 -receptor by diminishing affinity for α_2 -receptors. *Ex:* Tolazoline, Phentolamine.

Phentolamine and Tolazoline are substituted imidazolines, which have a wide range of pharmacological actions, including, α -adrenergic blockade, sympathomimetic activity, cholinomimetic activity and histamine-like actions. Slight changes in their structure may make one or another of these properties dominant.

Tolazoline. Tolazoline is a substituted imidazoline derivative. It is prepared by condensation of an aminoether (obtained by methanolysis of phenylacetonitrile) with ethylene diamine.

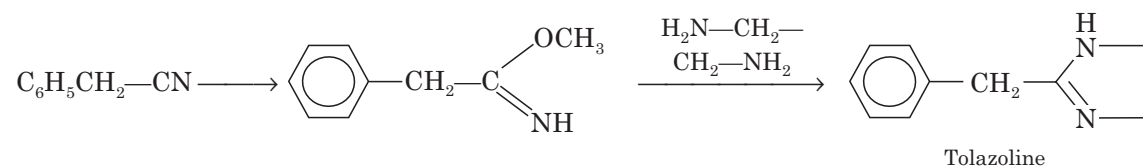

Tolazoline has been used in the treatment of persistent pulmonary hypertension of the newborn. It is mainly used in Raynaud's disease. Tolazoline is available both as tablet and as injection.

Phentolamine. Phentolamine is an imidazoline derivative. It is prepared by the following chemical reactions;

N-(4-methylphenyl)-3-hydroxyaniline on condensation with hydrogen cyanide and formaldehyde gives N-(4-methylphenyl)-3-hydroxy anilinoacetonitrile which on further treatment with ethylene diamine gives phentolamine.

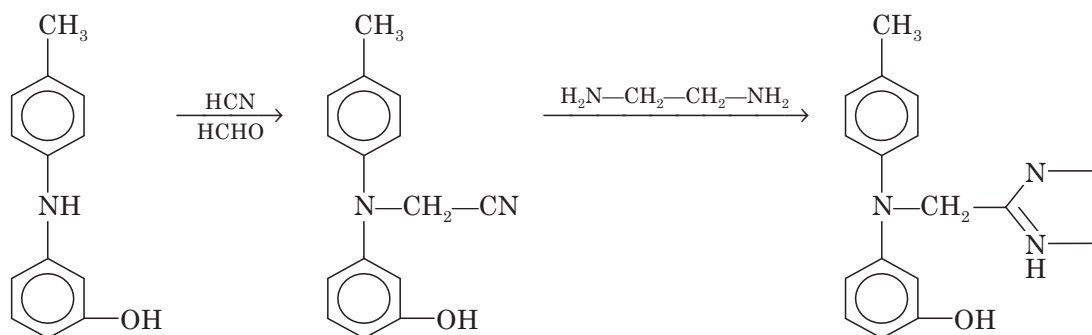

Phentolamine has similar affinities for α_1 and α_2 receptors. It produces vasodilation and fall in blood pressure. However, very large doses of phentolamine can block other actions of 5-HT.

Uses. Phentolamine is used for the diagnosis and treatment of pheochromacytoma. It is also used to treat Raynaud's syndrome.

β -HALOALKYLAMINES. They are represented by the following formula:

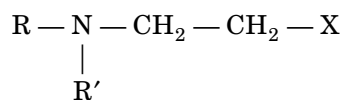

R or R' = Arylalkyl group

X = Halogen

Ex: Phenoxybenzamine, dibenamine

(i) β -Haloalkylamines resemble to antineoplastic agents(nitrogen mustard) but have no cytotoxic effects.

(ii) The effectiveness of β -haloalkylamines depend upon the nature of R and R¹-groups.

(iii) The groups attached to the nitrogen are responsible for the transport of the drug to the receptor area and binding to the receptor surface.

(iv) These agents are closely related to the nitrogen mustards, and like the later, the tertiary amine cyclises to form a reactive ethyleniminium intermediate. The molecular configuration responsible for blockade is probably a highly reactive carbonium compound, formed when the ring structure breaks, which binds covalently and irreversibly to the receptor. The formation of these intermediates accounts for the delayed onset of action, even after i.v. administration.

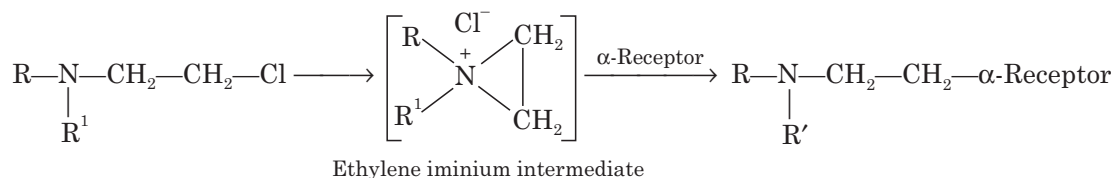

(v) They have long duration of action and are non-selective.

Phenoxybenzamine. Phenoxybenzamine is moderately selective for α_1 -receptors It is synthesized as follows :

(a) Condensation of phenol with propylene chlorohydrin gives 1-phenoxy-2-propanol, which on reaction with thionyl chloride produces 1-phenoxy-2-chloro propane.

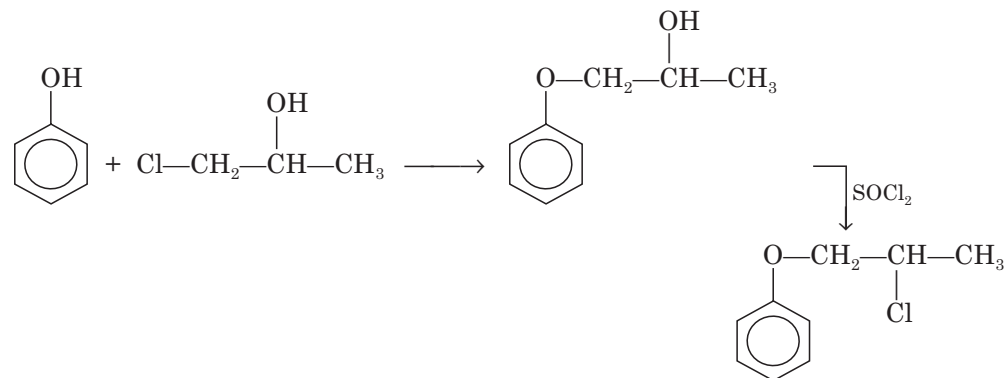

(b) 1-Phenoxy-2-chloropropane is condensed with ethaolamine followed by benzyl chloride yields phenoxybenzamine.

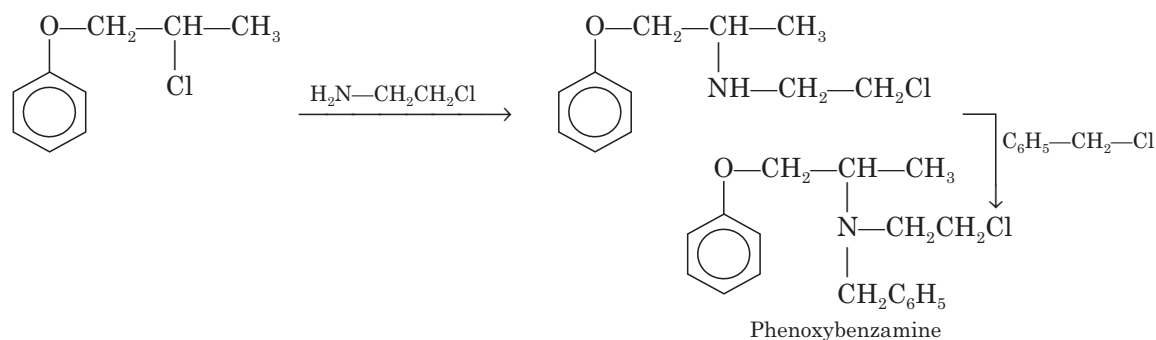

Phenoxybenzamine selectively block α_1 -receptors and have no agonist activity their effects are due to a direct action on α -receptors.

Dibenamine. Reaction of dibenzylamine with ethylene oxide provides aminoalcohol, which on treatment with thionyl chloride provides dibenamine.

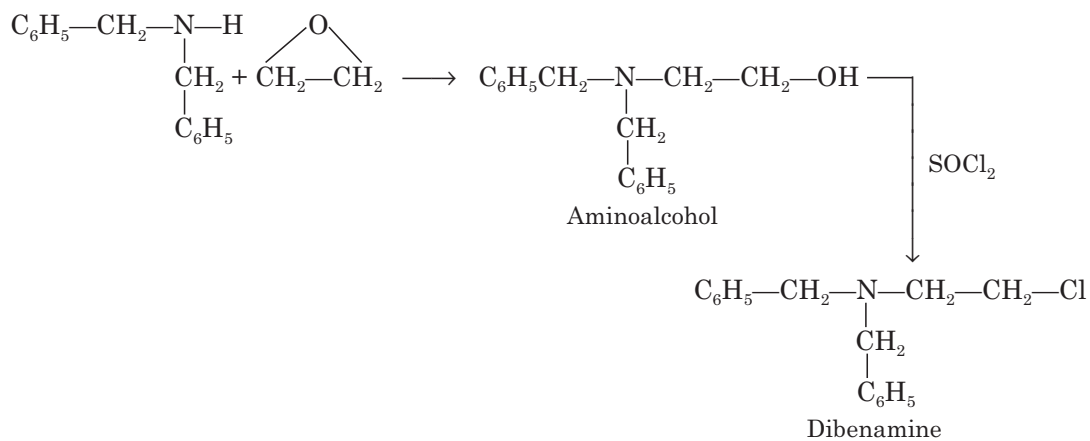

13

Skeletal Muscle Relaxants

Definition

Skeletal muscle relaxants are used to decrease muscle spasm or spasticity that occurs in certain neurologic and musculoskeletal disorders. They relax striated muscles (those that control the skeleton) and are used during intubations and surgery to reduce the need for anesthesia and facilitate intubation.

Muscle Spasm

Muscle spasm or cramp is a sudden, involuntary, painful muscle contraction that occurs with trauma or an irritant. Spasms may involve alternating contraction and relaxation (clonic) or sustained contraction (tonic). It is also encountered with acute or chronic low back pain, a common condition that is primarily a disorder of posture.

Spasticity

Spasticity involves increased muscle tone or contraction and stiff, awkward movements. It occurs with neurologic disorders such as spinal cord injury and multiple sclerosis.

Purpose

Skeletal muscle relaxants may be used for relief of spasticity in neuromuscular diseases, such as multiple sclerosis, as well as for spinal cord injury and stroke. They may also be used for pain relief in minor strain injuries and control of the muscle symptoms of tetanus.

Classification

The muscle relaxants may be divided into only two groups:

(i) **Centrally acting muscle relaxants.** The centrally acting group, which appears to act on the central nervous system. *Ex:* Baclofen, carisoprodol, chlorphenesin, methocarbamol.

(ii) **Peripherally acting muscle relaxants.** *Ex:* Dantrolene.

Mechanism of Action

All skeletal muscle relaxants except dantrolene are centrally active drugs. Only dantrolene has a direct action at the level of the nerve-muscle connection. Pharmacologic action is usually attributed to general depression of the central nervous system (CNS), but may involve blockage of nerve impulses that cause increased muscle tone and contraction. It is unclear whether relief of pain results from sedative effects, muscular relaxation, or a placebo

effect. In addition, although parenteral administration of some drugs (*e.g.*, diazepam, methocarbamol) relieves pain associated with acute musculoskeletal trauma or inflammation.

Baclofen and diazepam increase the effects of gamma-aminobutyric acid, an inhibitory neurotransmitter. Dantrolene is the only skeletal muscle relaxant that acts peripherally on the muscle it self. It inhibits the release of calcium in skeletal muscle cells and thereby decreases the strength of muscle contraction.

BACLOFEN

Baclofen is (RS)-4-amino-3-(4¹-chlorophenyl)butyric acid.

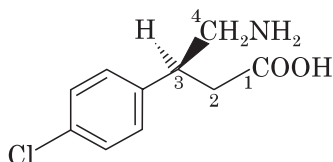

Properties. A white or almost white powder, slightly soluble in water, very slightly soluble in alcohol, practically insoluble in acetone and in ether. It dissolves in dilute mineral acids and in dilute solutions of alkali hydroxides. It shows polymorphism.

Mechanism of action. Baclofen is a central skeletal muscle relaxant. It is an antispastic. It inhibits both monosynaptic and polysynaptic reflexes at spinal level. It is an analog of GABA and exerts its action by stimulating GABA_B receptor subtype. Baclofen also acts as a general CNS depressant.

Uses. Baclofen is used to treat spasticity of skeletal muscles, degenerative traumatic and neoplastic, multiple sclerosis and spasticity of cerebral origin. The action of oral baclofen starts in 1 hour, reaches in 2 hours, and lasts for 4 to 8 hours. It is metabolized in the liver and excreted in urine. Its half-life is 3 to 4 hours.

CARISOPRODOL

Carisoprodol is N-isopropyl-2-methyl-2-propyl-1,3-propanediol dicarbamate.

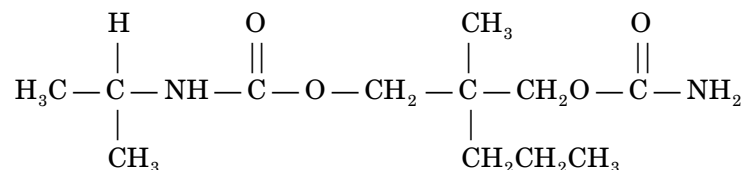

Properties. Carisoprodol occurs as white, crystalline powder and melts at 93°C. It has slight bitter taste.

Mechanism of action. Carisoprodol blocks interneuronal synaptic activity in the ascending reticular formation and spinal cord. This results in skeletal muscle relaxation.

Uses. It is used to relieve discomfort from acute, painful, musculoskeletal disorders. It is not recommended for long-term use and, if used long term or in high doses, it can cause physical dependence (*i.e.*, symptoms of withdrawal if stopped abruptly). Oral drug acts within 30 minutes, peak levels in 1 to 2 hours and lasts 4 to 6 hours.

CHLORPHENESIN

Chlorphenesin is 4-chlorophenylether of glycerol.

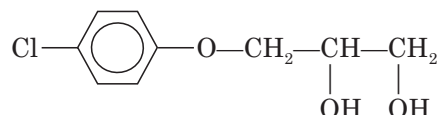

Properties. Chlorphenesin occurs as white crystals. It melts at 80°C. Chlorphenesin is synthesized by condensation of 4-chlorophenol with 3-chloro-1, 2-propanediol.

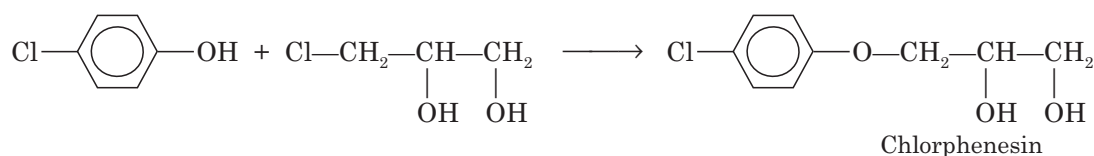

Uses. Chlorphenesin is used to relieve discomfort from acute, painful, musculoskeletal disorders. Oral drug effects peak in 1 to 3 hours and last 8 to 12 hours; half-life is 3.5 hours. The drug is metabolized in the liver and excreted in urine. Common adverse effects are drowsiness, dizziness, confusion, nausea.

METHOCARBOMOL

Methocarbamol is 3-(*o*-methoxyphenoxy)-1,2-propanediol-1-carbamate.

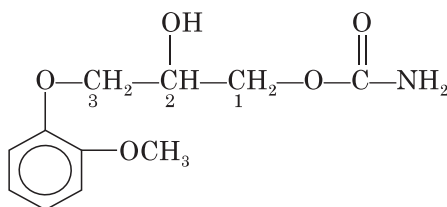

Properties. Methocarbamol occurs as fine, white colored, odorless powder. It is slightly soluble in water and freely soluble in alcohol.

Methocarbamol is synthesized by transesterification reaction of 3-(*o*-methoxyphenoxy)-1, 2-propanediol with ethyl carbonate in presence of alkali catalyst followed by treatment with ammonia.

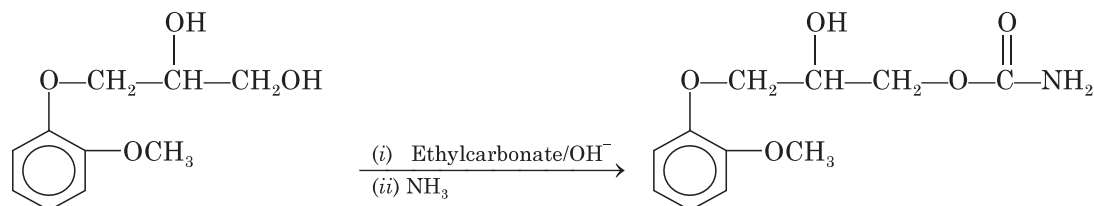

Methocarbamol is a centrally acting skeletal muscle relaxant whose precise mode of action is not known. It would cause general depression of nervous system.

Uses. Methocarbamol is used in the treatment of muscle spasm resulting from injury, musculoskeletal disorders. It is also used to treat paralysis agitans, cerebral palsy, multiple sclerosis and cerebral vascular accidents.

DANTROLENE

Dantrolene acts directly on skeletal muscle to inhibit muscle contraction. It is used to relieve spasticity in neurologic disorders (*e.g.*, multiple sclerosis, spinal cord injury) and to

prevent or treat malignant hyperthermia. Oral drug acts slowly, peaks in 4 to 6 hours and lasts 8 to 10 hours. IV drug acts rapidly, peaks in about 5 hours and lasts 6 to 8 hours.

Dantrolene occurs as sodium salt. Dantrolene sodium is 1-[[5-(*p*-nitrophenyl) furfurylidene]amino]hydantoin sodium. It is orange colored, slightly water soluble powder.

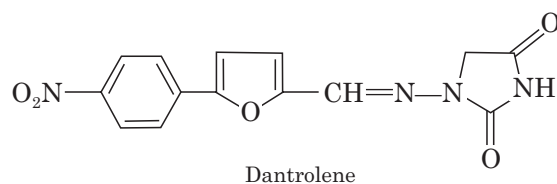

Dantrolene

Side-effects of skeletal muscle relaxants. Frequently sedation, drowsiness, muscular hypotonia, nausea, urinary disturbances; occasionally lassitude, confusion, speech disturbance, dizziness, ataxia, hallucinations, nightmares, headache, euphoria, insomnia, depression, anxiety, agitation, tremor, nystagmus, paraesthesias, convulsions, myalgia, fever, respiratory or cardiovascular depression, hypotension, dry mouth, gastro-intestinal disturbances, sexual dysfunction, visual disorders, rash, pruritus, urticaria, hyperhidrosis, angioedema; rarely taste alterations, blood sugar changes, and paradoxical increase in spasticity.

14 Antihistamines

WHAT ARE ALLERGIES ?

An allergy is a response by your body to something that is ordinarily harmless. The purpose of the immune system is to recognize harmful infection-causing invaders and to get rid of them. However, for some people, the immune system overreacts to ordinarily harmless substances like indoor allergens such as pet dander, pollen, dust, mold and outdoor allergens such as pollen from grass, trees and weeds. These people have “allergies.” Their bodies attempt to expel these ordinarily harmless substances, causing sneezing; a runny nose; itchy, watery eyes and sometimes hives.

HOW ALLERGIES DEVELOP ?

Nobody knows for sure, although the tendency to develop allergies can be inherited from your parents. Scientists do know how a person develops allergies. The first thing that happens is

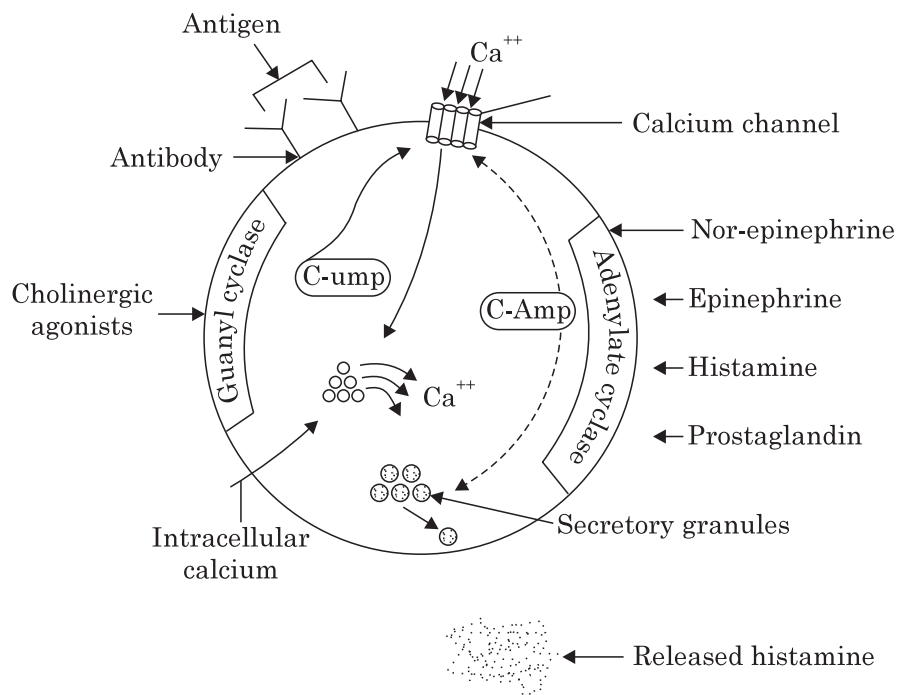

Histamine release from mast cells. (Solid lines-activation dotted lines-inhibition)

you are exposed to a particular substance—for example, pollen from a ragweed plant. This substance makes its way to your nose, where your immune system detects it and, considering it a harmful invader, creates antibodies to fight that particular substance. These antibodies stay in your system, and bound to the surface of mast cells and results in the release of histamine.

THE HISTAMINE CONNECTION

Histamine is a major component of many venoms and sting secretions and is produced naturally by the immune system and released in response to tissue damage. In humans, histamine mediates immediate allergic and inflammatory responses, causes gastric acid release and functions as a central nervous system neurotransmitter.

Systemically, histamine contracts smooth muscle of lungs and gastrointestinal system and causes vasodilation, low blood pressure (hypotension) and increased heart rate (tachycardia). Histamine attaches to nearby blood vessels, causing them to swell, and secrete more fluid than usual. Histamine can also irritate nearby nerve endings, causing itching. Ultimately, histamine causes symptoms such as sneezing; itchy, watery eyes, and a runny nose.

HISTAMINE CONTENT OF HUMAN TISSUES

Histamine is stored in some organs in granules of mast cells, basophils together with heparin and proteases. It is stored at sites other than mast cells in epidermis, gastric mucosa, neurons, regenerating tissues, and in basophils of blood. Histamine is rapidly synthesized, but not taken up by cells. Histamine is 2-(4-imidazolyl)ethylamine is biosynthesized from histidine by the action of L-histidine carboxylase.

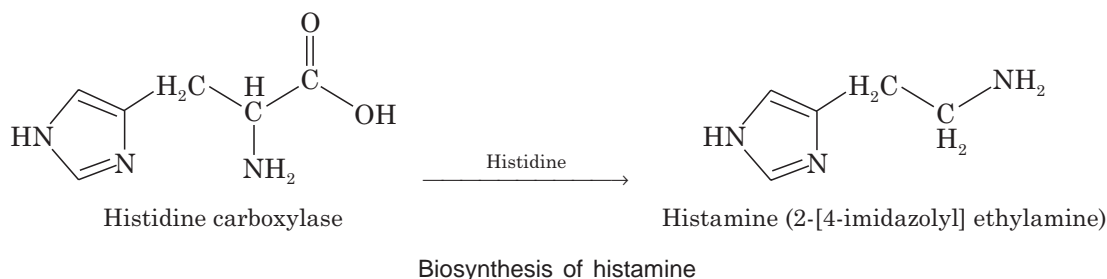

HISTAMINE RECEPTORS

Histamine carries its message to a large number of cells by attaching to a special receptor on the cells' surfaces. There are two kinds of histamine receptors, H_1 and H_2 . The H_1 and H_2 receptors both receive histamine as a messenger, but the meaning taken by the different receptors is different. H_1 receptors tend to produce the symptoms already listed and activate allergic reactions. H_2 receptors tend to act as negative feedback receptors and turn the allergic

reaction off. H_2 receptors also exclusively activate the acid-producing, parietal cells of the stomach lining. An H_3 receptor, discovered in 1987, appears to exist only in the central nervous system.

During 2000 and 2001, a new membrane receptor, the H_4 has been discovered, which is located in the immune system.

Agonist	Receptor	Location	Effect
2-Methylhistamine	H_1	CNS Blood vessels, endothelial cells Bronchi	Cyclic GMP increases, Headache ; Wakefulness, Arterial vasodilation Postcapillary venules constriction
		Ileum Heart Adrenals Nose, bronchi	Smooth muscle contraction Smooth muscle contraction Increased coronary blood flow Release of catecholamines Increased exocrine secretion
4-Methylhistamine	H_2	Heart Mast cells Stomach Blood vessels, smooth muscles	Chronotrophy, inotrophy Negative feedback Acid production Slow drop in pressure
α -Methylhistamine	H_3	Brain Airways, neurons GI tract	Negative feedback on histamine release (sedative action) Inhibitory action on some forms of bronchoconstriction Acetylcholine release inhibited

PATHWAYS OF HISTAMINE METABOLISM IN HUMANS

Histamine from α -histidine amino acid, is metabolized by the following pathway in humans :

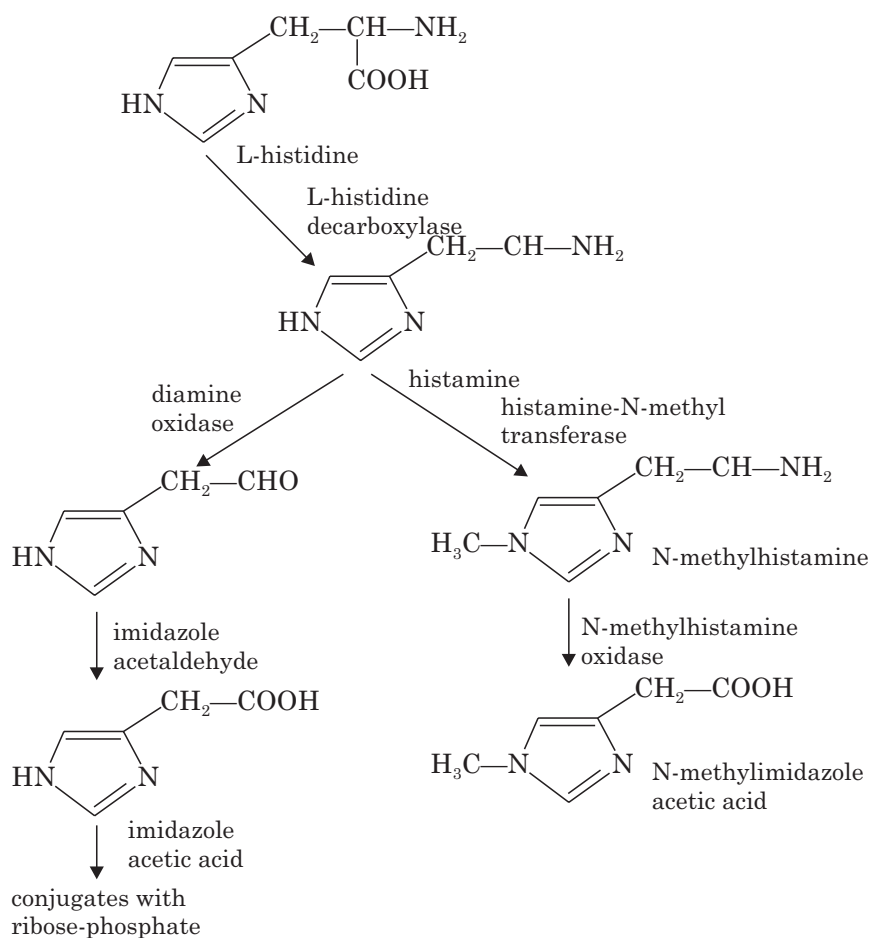

Synthesis and metabolism of histamine.

WHAT ARE ANTIHISTAMINES ?

Antihistamines are drugs that block the action of histamine at the H_1 receptor sites, responsible for immediate hypersensitivity reactions such as sneezing and itching. Members of this class of drugs may also be used for their side effects, including sedation and antiemesis (prevention of nausea and vomiting). H_1 antihistamines antagonize all actions of histamine except for those mediated by H_2 receptors. The H_2 receptor antagonists are the drugs that inhibit competitively the interaction of histamine with H_2 receptors. H_2 receptor antagonists inhibit gastric acid secretion induced by histamine thus they are used to treat gastric and duodenal ulcers.

Antihistamines do not cure allergies or prevent histamine from being released. They also have no effect on other chemicals that the body releases when exposed to allergens. For these reasons, antihistamines can be expected to reduce allergy symptoms by only about 50%. In some people antihistamines become less effective when used over a long time. Some times switching to another type of antihistamine may help to cure allergic reactions.

HOW DO ANTIHISTAMINES WORK

An antihistamine is not actually the opposite of a histamine. An antihistamine is a drug that binds to certain sites (receptors on cells) in the body, in order to prevent histamine from binding. Antihistamines act as competitive inhibitors of histamine (agonist) binding. Antihistamines compete for the H_1 receptors on blood vessel endothelial cells and smooth muscle cells. As competitive inhibitors, the antihistamines bind to the receptors because there is more of the antihistamine than the natural histamine. Antihistamines have no effect on rate of histamine release, nor do they inactivate histamine.

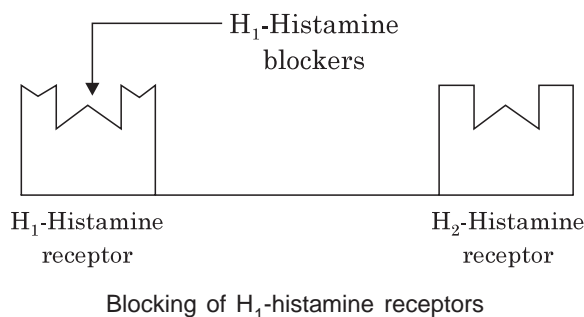

CLASSIFICATION OF ANTIHISTAMINES

Antihistamines are generally categorized as first- and second-generation, which generally based on whether they cause greater or lesser sedation.

First-Generation antihistamines. The older, so-called first generation antihistamines include:

1. **Aminoalkylethers.** Diphenhydramine, carbinoxamine, bromodiphenhydramine, doxylamine.
2. **Ethylenediamines.** Tripelennamine, clemastine, pyrillamine, methapyrilene.
3. **Propylamine derivatives.** Chlorpheniramine, pheniramine, dexchlorpheniramine, brompheniramine, dexbrompheniramine, triprolidine.
4. **Phenothiazine derivatives.** Promethazine, trimeprazine, methdilazine.
5. **Piperazine derivatives.** Cyclizine, chlorcyclizine, meclizine, buclizine.
6. **Debenzocycloheptenes.** Cyproheptadine, azatadine.
7. **Miscellaneous drugs.** Diphenyl pyraline, dimethindene, antazoline.

Second-Generation antihistamines. The second-generation antihistamines bind only to peripheral H_1 receptors, and reduce allergic response with little or no sedation. Ex: Cetirizine, loratidine, fexofenadine.

STRUCTURE ACTIVITY RELATIONSHIPS OF HISTAMINE H₁-ANTAGONISTS

The essential pharmacophore for histamine H₁ antagonistic activity is:

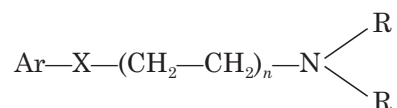

1. The nitrogen should be 3° in nature for maximum antihistaminic activity. The 'N' may also form a part of heterocyclic moieties like piperidine, or piperazine or diazocine. The nitrogen amine should be separated by 5-6 Å from aromatic or heteroaromatic group.
2. The group present between nitrogen atom and group X may be saturated or unsaturated or substituted.
3. The Ar group may be aryl or heteroaryl, which may be substituted.
4. The group (X) can be carbon, oxygen or nitrogen.

Aminoalkyl Ether Derivatives

1. The basic structure of aminoalkyl ethers for H₁ antihistaminic activity:

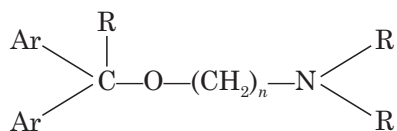

2. The aromatic groups may be phenyl or substituted phenyl or heterocyclic for good antihistaminic activity. The R group may be methyl or hydrogen.
3. If double bond is introduced between α, β-carbon atoms of propyl chain, drowsiness will be developed Ex: acrilastine.

DIPHENHYDRAMINE

Diphenhydramine is chemically an ethanolamine, and in addition to its role in reducing allergic reactions, may be used as a night time sedative, for control of drug-induced parkinsonism, and, in liquid form, for control of coughs. Diphenhydramine occurs as hydrochloride salt which is 2-benzhydryloxyethyl dimethyl hydrochloride.

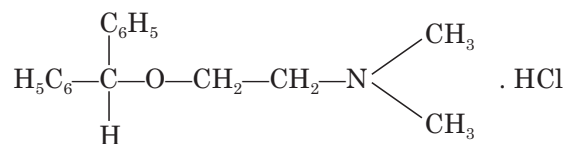

Diphenhydramine hydrochloride

Diphenhydramine hydrochloride is water soluble white crystalline powder. It should be stored in light resistant containers. Diphenhydramine is prepared from diphenylmethane by the following reactions:

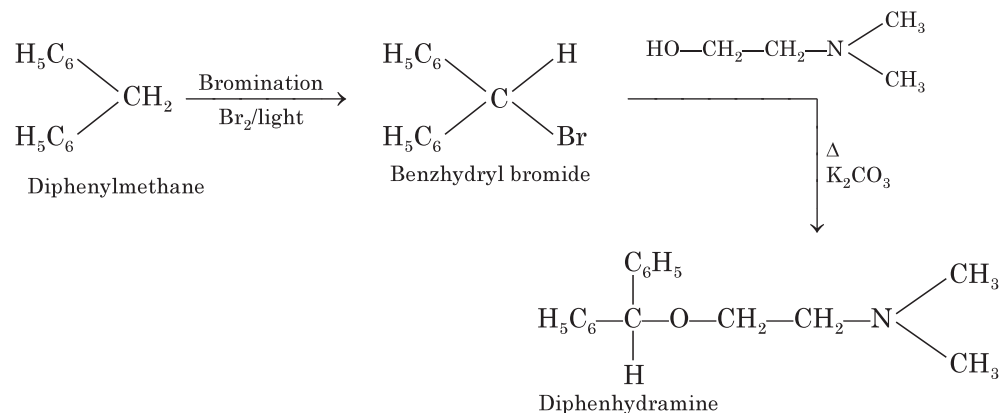

Carbinoxamine

1. **Chemistry.** Carbinoxamine is available as carbinoxamine maleate. Chemically it is 2-[-p-chloro-(2-(dimethylamino) ethoxy) benzyl] pyridine maleate.

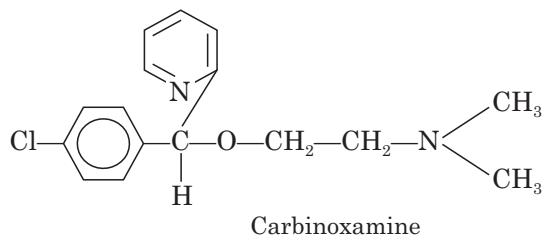

2. **Characters.** It occurs as white, odorless, crystalline powder. It is freely soluble in water, alcohol, and chloroform.

3. **Synthesis.** Piconaldehyde by Grignard reaction with p-chlorophenylmagnesium bromide gives an intermediate which is converted to carbinoxamine by adding N-dimethylaminoethyl chloride in presence of sodamide.

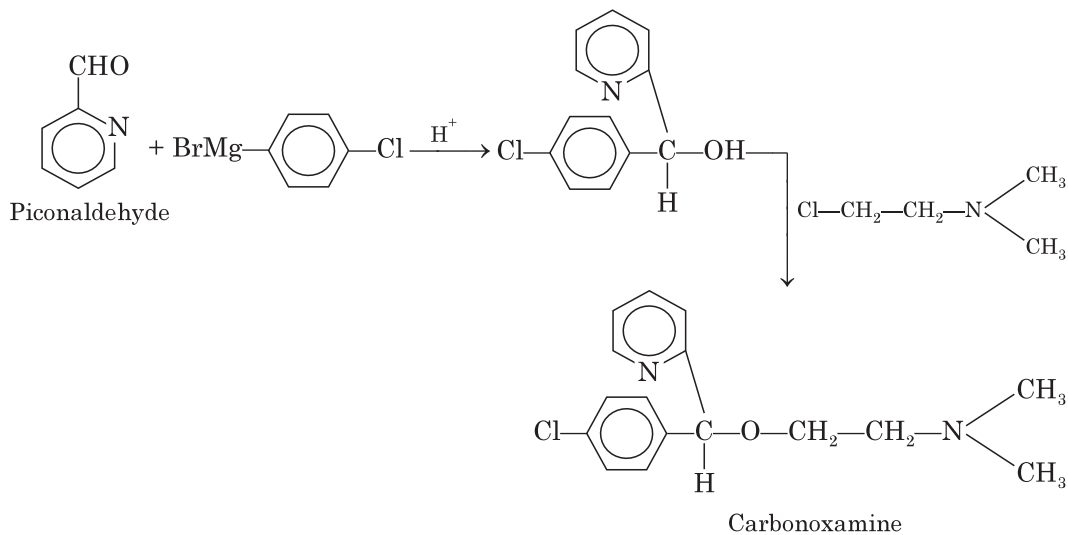

4. **Uses.** (i) Carbinoxamine is an antihistamine with anticholinergic and antiemetic activities.

(ii) It is effective in allergic rhinitis, vasomotor rhinitis, and allergic conjunctivitis.

Bromodiphenhydramine

1. **Chemistry.** Bromodiphenhydramine is 2[(4-bromophenyl) phenylmethoxy]-N,N-dimethylethanamine.

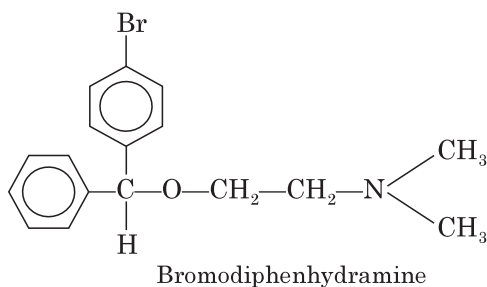

2. **Characters.** It occurs as hydrochloride salt. Bromodiphenhydramine HCl is a white crystalline, water-soluble powder.

3. **Synthesis.** Bromodiphenhydramine is synthesized from 4-bromobenzaldehyde by the following chemical reactions:

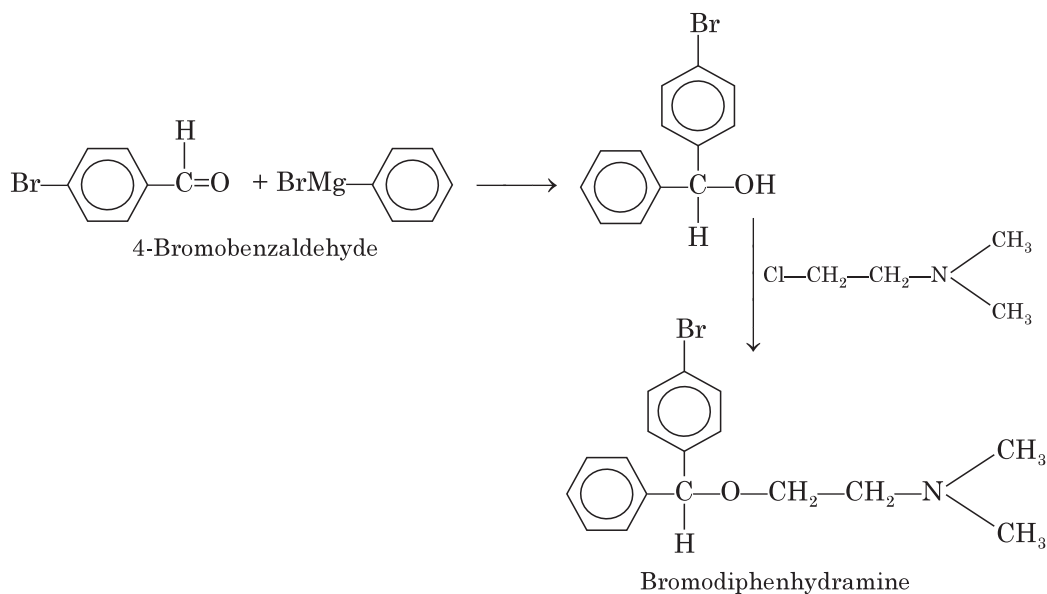

Dimenhydrinate

Dimenhydrinate is aminoalkyl ether. It is 8-chlorotheophyllinate salt of diphenhydramine. Dimenhydrinate is a white crystalline, colorless, slightly water-soluble powder. It is used to treat motion-sickness, nausea and vertigo.

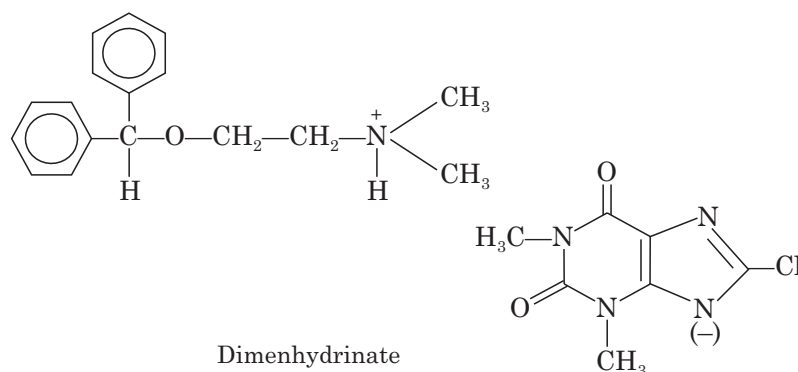

Doxylamine

1. **Chemistry.** Doxylamine occurs as doxylamine succinate. Chemically it is 2-[-[2-(dimethylamino) ethoxy]-(-methylbenzyl)] pyridine succinate. Doxylamine succinate is white, characteristic odor, water or alcohol soluble powder.

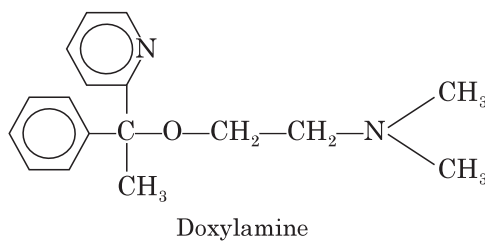

2. **Uses.** (i) Doxylamine is an antihistaminic agent but it has sedative effect.
(ii) It is also used with antitussives and decongestants for the relief of cough and cold.

Clemastine

1. **Chemistry.** Clemastine is an alkyl ether derivative possessing of pyrrolidine nucleus. It occurs as clemastine fumarate. Chemically, clemastine is 2-[2-[1-(*p*-chlorophenyl)-1-phenylethoxy]ethyl]-1-methylpyrrolidine.

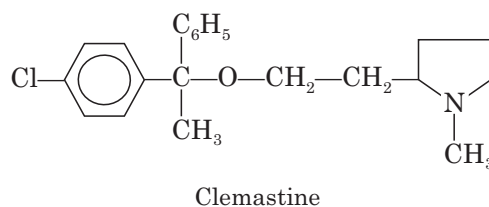

2. **Characters.** Clemastine fumarate is white or slightly yellow colored, crystalline powder. It is slightly soluble in water and alcohol.

3. **Uses.** Clemastine has antihistaminic activity with anticholinergic and sedative effects.

ETHYLENEDIAMINES

1. The basic structure of ethylene diamine derivatives of H_1 antagonists is:

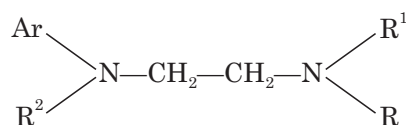

2. R and R^1 are methyl groups, R^2 may be phenyl, benzyl or heterocyclic and Ar may be phenyl or heterocyclic for antihistaminic activity.

3. All compounds of this series have two 3° nitrogens which are separated by a two carbon atom chain. Substitution of heterocyclic groups for Ar or introduction of alkoxy groups into group (R^2) produce effective antihistaminic compounds with reduced drowsiness.

4. The ethylenediamines are highly effective H_1 antagonists and are useful antihistamines. They also exhibit high frequency CNS depression and gastrointestinal side effects.

Pyrilamine

1. **Chemistry.** Pyrilamine is an ethylene diamine derivative. Pyrilamine occurs as maleate salt. Chemically it is 2-[[2-(dimethylamino) ethyl] (p-methoxybenzyl) amino] pyridine maleate.

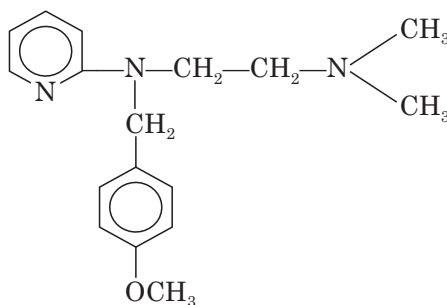

2. **Characters.** Pyrilamine maleate is white, characteristic odor, water or alcohol soluble, crystalline powder.

3. **Synthesis.** The following steps synthesize pyrilamine:

(i) 2-Aminopyridine by alkylation with chloroethyldimethylamine yields diamine.

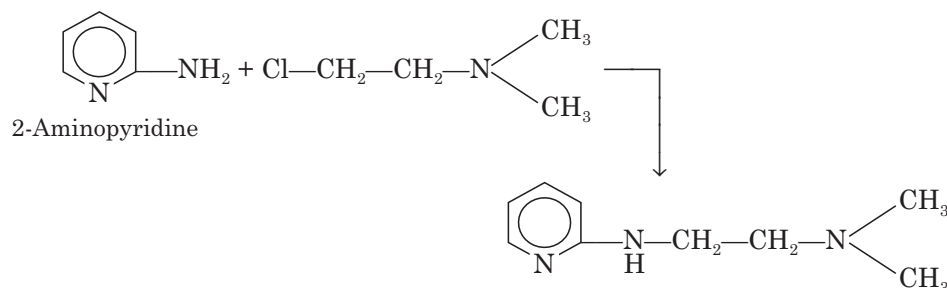

(ii) Reaction of diamine with p-methoxybenzylchloride gives pyrilamine

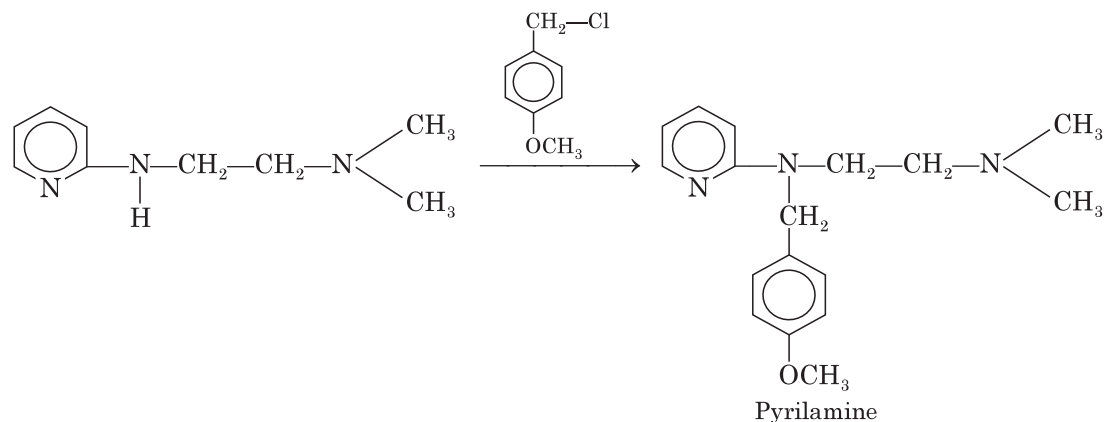

4. **Uses.** (i) Pylramine has antihistaminic activity

(ii) It is also used in cough formulations

Methapyrilene

1. **Chemistry.** Methapyrilene is an ethylenediamine with pyridine nucleus. It is an H_1 -receptor antagonist. It is 2-[[2-(dimethylamino) ethyl] 2-thenylamino]-pyridine.

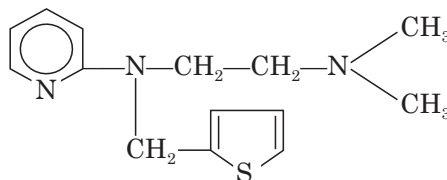

2. **Properties.** Methapyrilene occurs as hydrochloride salt. Methapyrilene hydrochloride is water soluble, white crystalline powder.

3. **Synthesis.** Methapyrilene is prepared from 2-aminopyridine by the following steps:

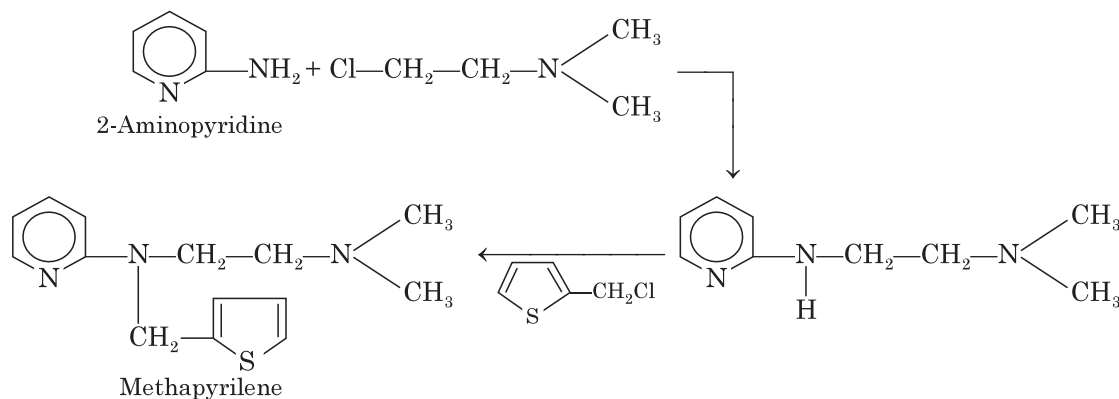

Thonzylamine

1. **Chemistry.** Thonzylamine occurs as hydrochloride salt. Chemically thonzylamine is 2-((2-(dimethylamino)ethyl) (p-methoxybenzyl)amino) pyrimidine. Thonzylamine hydrochloride

is a water soluble, white crystalline powder. It is an Histamine H_1 -receptor antagonist used for the symptomatic relief of hypersensitivity disorders.

2. Synthesis. Thonzylamine is prepared from 2-aminopyrimidine by the following steps:

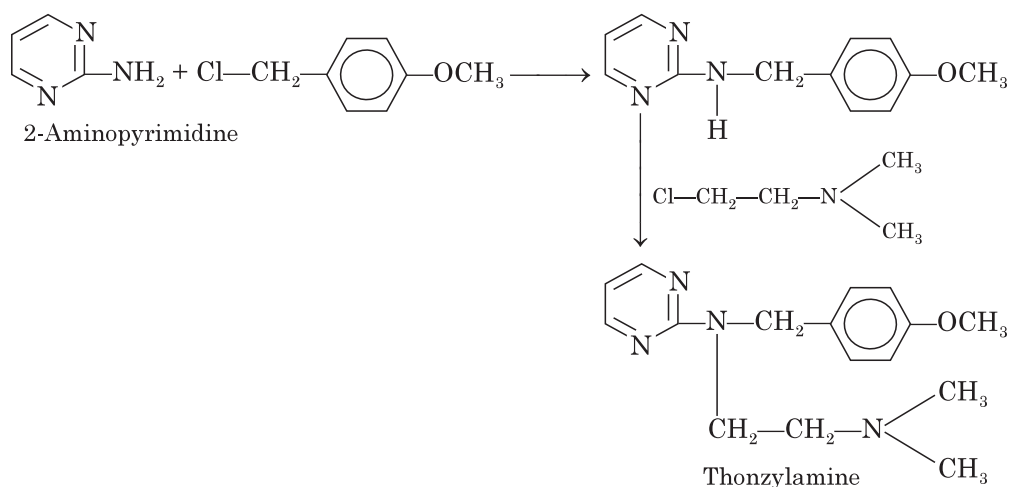

PROPYLAMINE DERIVATIVES

1. The propylamine antihistamine derivatives possess the following general structure:

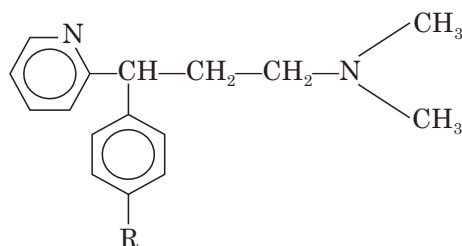

2. They are most active H_1 -antagonists and also produce less sedation.
3. They exhibit significant anticholinergic activity in addition to antihistaminic activity.
4. All propylamine antihistamine derivatives are chiral compounds.
5. Propylamines possess sp^3 or sp^2 carbon bridge between terminal tertiary amino group and diaryl moieties.

Pheniramine

1. **Chemistry.** Pheniramine is available as pheniramine maleate. It is dimethyl(3-phenyl-3-(2-pyridyl)propyl)amine hydrogen maleate.

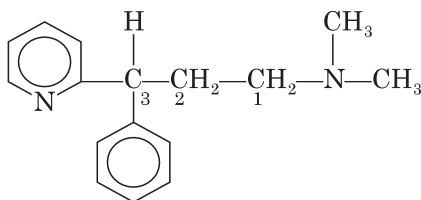

2. **Characters.** Phemiramine maleate is water soluble, white, crystalline powder.

3. **Synthesis.** Phemiramine is prepared by condensation of 2-benzylpyridine with dimethylaminoethyl chloride in presence of sodamide.

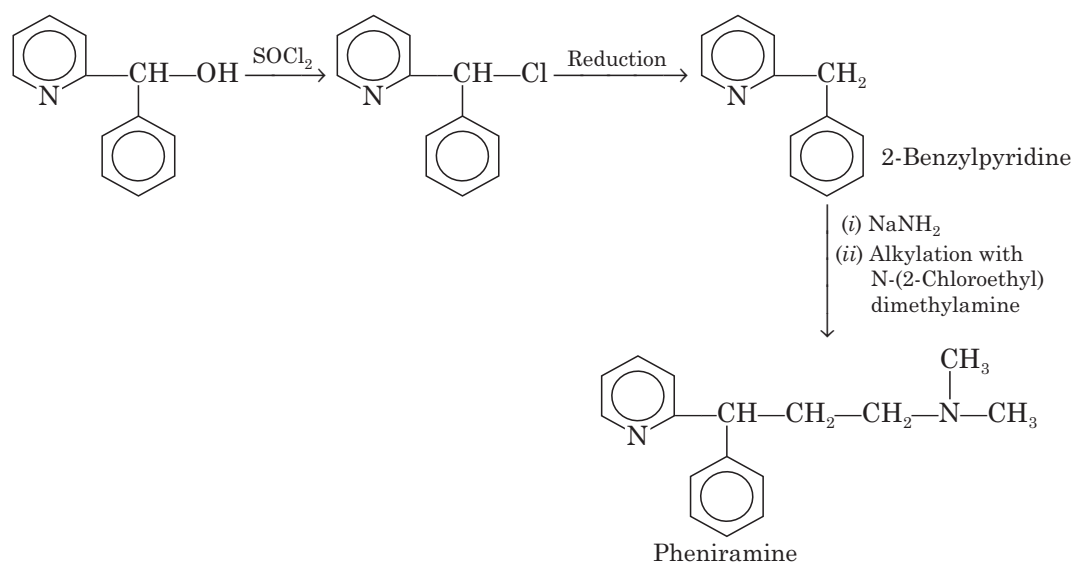

4. **Uses.** Phemiramine is an antihistaminic agent. It is effective to treat allergic rhinitis, vasomotor rhinitis, allergic conjunctivitis, mild urticaria and angioedema. It is used widely in cough preparations.

Chlorpheniramine

1. **Chemistry.** Chlorpheniramine occurs as chlorpheniramine maleate, which is an alkylamine derivative. It is (RS)-3-(4-chlorophenyl)-3-(2-pyridyl) propyldimethylamine hydrogen maleate. Chlorpheniramine maleate is water soluble, white crystalline powder.

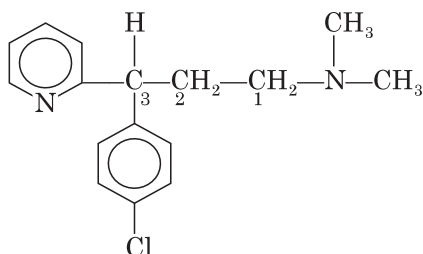

2. **Synthesis.** Chlorpheniramine is synthesized from p-chlorobenzyl nitrile by following synthetic route:

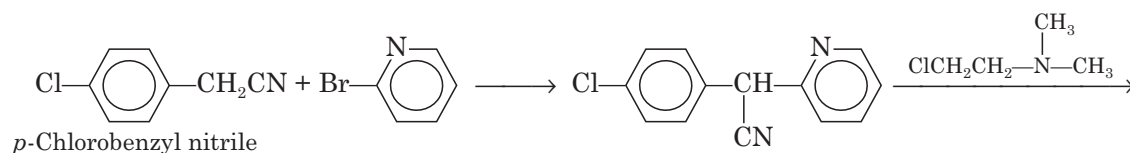

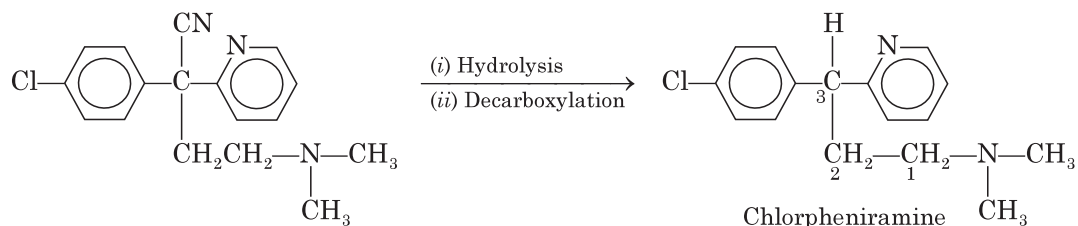

3. Uses. Chlorpheniramine is a Histamine H_1 -receptor antagonist used for the symptomatic relief of hypersensitivity reactions including urticaria, rhinitis, conjunctivitis and angioedema. It is a potent antihistamine and causes moderate degree of sedation. It also has antimuscarinic activity.

Brompheniramine

Brompheniramine maleate is 3-(4-bromophenyl)-3-(2-pyridyl) propyldimethylamine hydrogen maleate. It is an optically active compound. Dexbrompheniramine is (+)- isomer and is more potent than (-)-isomer. It is water soluble, white crystalline powder.

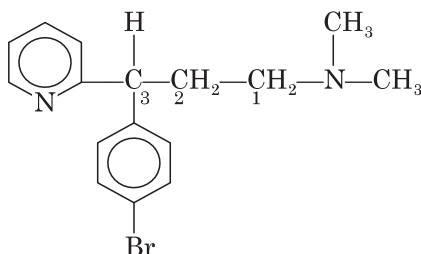

Uses. Brompheniramine is an antihistamine with anticholinergic and sedative effects. It is effective for the relief of hayfever and upper respiratory allergic systems such as itchy, watery eyes, sneezing, itching nose etc.

Tripolidine

1. Chemistry. Tripolidine is a pyrrolidine derivative. It possesses pyrrolidine and pyridine moieties. Tripolidine occurs as hydrochloride salt. It is 2-(3-(pyrrolidin-1-yl)-1-p-tolylprop-1-enyl) pyridine hydrochloride. The following steps synthesize tripolidine:

(i) An amino ketone is synthesized by Mannich condensation of p-methylacetophenone with formaldehyde and pyrrolidine.

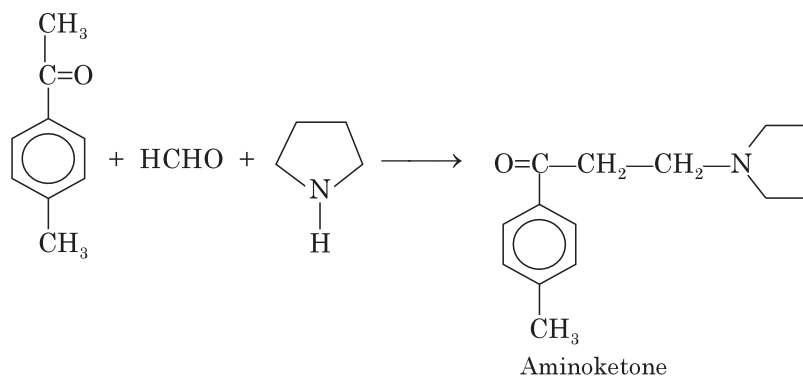

(ii) Aminoketone on reaction with organometallic reagent of 2-bromopyridine gives an aminoalcohol.

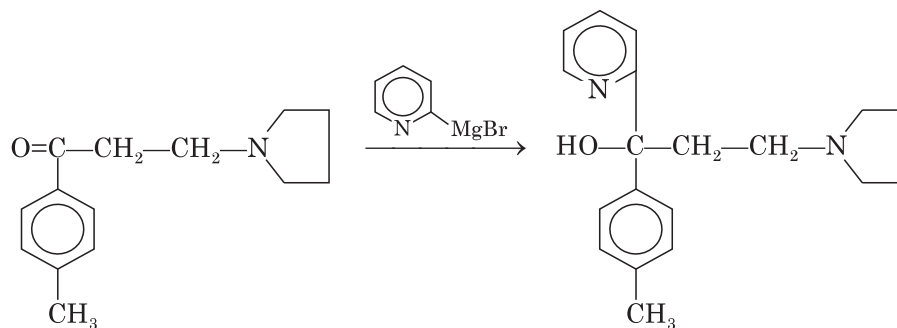

(iii) Aminoalcohol on dehydration leads to triprolidine.

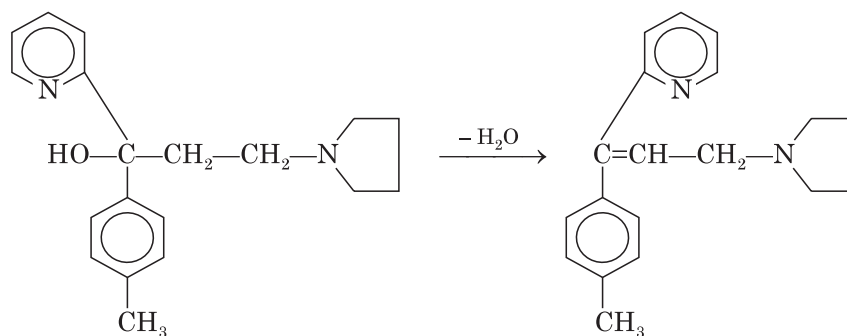

2. **Characters.** Triprolidine hydrochloride is a water soluble, white, crystalline powder.

3. **Uses.** Triprolidine is a potent antihistamine used for the symptomatic relief of hypersensitivity reactions including urticaria, rhinitis, conjunctivitis and for pruritic skin disorders. It is also used with pseudoephedrine for the treatment of cough and common cold.

PHENOTHIAZINES

1. Phenothiazines possess tricyclic system. They were introduced in 1945.
2. General structure of phenothiazine antihistamines is:

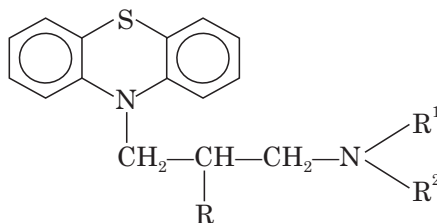

3. Phenothiazine derivatives possess two or three carbon chain bridge between basic phenothiazine nucleus and terminal nitrogen.

Trimeprazine

1. **Chemistry.** Trimeprazine is a phenothiazine derivative. It is 10-(3-dimethylamino-2-methyl propyl)-phenothiazine. It is more active than promethazine and less active than

chlorpromazine. Trimeprazine occurs as its tartarate salt. Trimeprazine is synthesized by alkylation of phenothiazine.

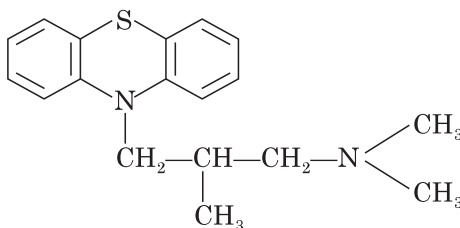

2. Characters. Trimeprazine tartarate is odorless, white colored crystalline powder. It should be protected from light.

3. Uses. Trimeprazine is effective for the treatment of pruritic symptoms due to urticaria. It is also effective to treat a variety of allergic and non-allergic conditions such as contact dermatitis, allergic dermatitis, drug rash etc.

Promethazine

1. Chemistry. Promethazine possess phenothiazine nucleus. Promethazine is 10-(2-dimethylaminopropyl) phenothiazine.

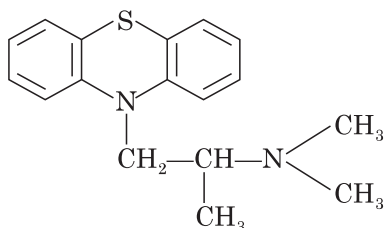

2. Characters. It occurs as hydrochloride salt. Promethazine hydrochloride is a white, colorless powder. It is freely soluble in water, soluble in alcohol, chloroform and practically insoluble in ether and acetone. It should be stored in airtight container and protect from light.

3. Synthesis. It is prepared by condensation of phenothiazine with 2-(N-dimethylamino)-1-chloropropane in presence of sodamide

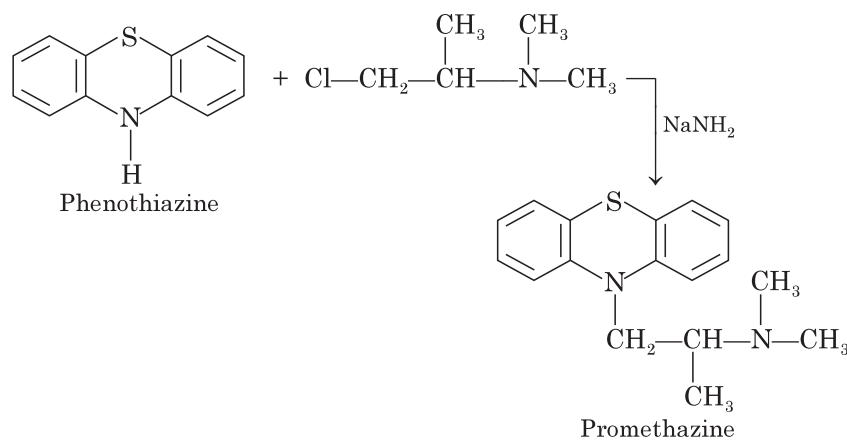

4. **Uses.** Promethazine is an antihistaminic agent with some anti muscarinic, antiemetic and local anesthetic properties. It is used for treatment of allergies, anxiety prior to surgery, as an anti-nauseant, and for control of motion sickness.

Methdilazine

1. **Synthesis.** Methdilazine is a phenothiazine derivative. Methdilazine is 10-(1-methyl-3-pyrrolidinyl)methylphenothiazine. It is prepared from phenothiazine by alkylation with N-methyl-3-chloromethyl pyrrolidine.

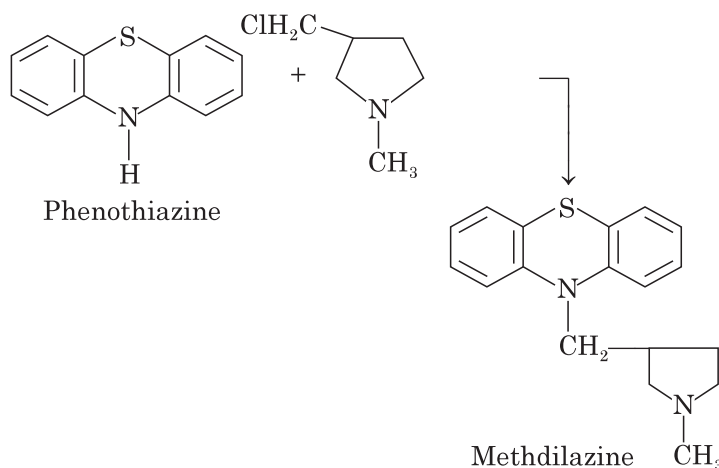

2. **Characters.** Methdilazine occurs as hydrochloride salt. Methdilazine hydrochloride is light tan crystalline powder having slight characteristic odor. It is freely soluble in water and alcohol.

3. Uses:

- (i) It has been used as antihistaminic agent to treat seasonal and perennial allergic rhinitis, vasomotor rhinitis, and allergic conjunctivites.
- (ii) It is also used to treat anaphylaxis.
- (iii) Methdilazine also possesses sedative effects and has local anesthetic properties.

Piperazines

- (i) Piperazines are derivatives of piperazine nucleus.
- (ii) The piperazine derivatives are moderately potent antihistaminics with a lower incidence of drowsiness.
- (iii) The general structure of piperazines is

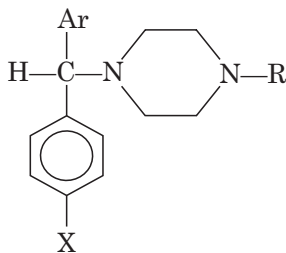

(iii) They are defined as cyclic ethylenediamines because the connecting group (CHN), the carbon chain ($-\text{CH}_2-\text{CH}_2-$) and terminal tertiary nitrogen are part of piperazine moiety.

Ex: Cyclizine, chlorcyclizine, meclizine and buclizine.

Cyclizine

1. **Chemistry.** Cyclizine is a piperazine derivative. It is 1-(diphenylmethyl)-4-methylpiperazine. Cyclizine occurs as hydrochloride salt.

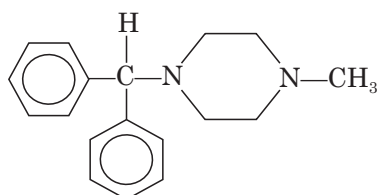

2. **Properties.** Cyclizine hydrochloride available as a white crystalline powder. It is slightly soluble in water, alcohol and chloroform.

3. **Synthesis.** Cyclizine is prepared by reaction of benzhydryl chloride with N-methylpiperazine.

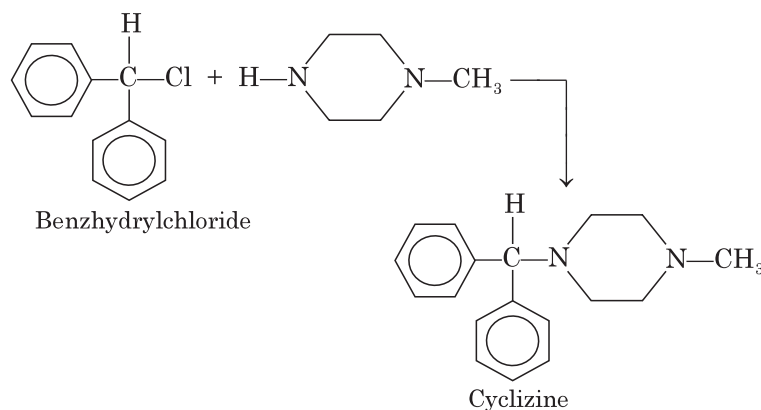

4. **Uses.** Cyclizine is a histamine H_1 -receptor antagonist given by mouth, or parenterally to control post-operative and drug induced vomiting, and motion-sickness.

Chlorcyclizine

1. **Chemistry.** Chlorcyclizine is also a piperazine derivative. It is 1-(p-chlorobenzhydryl)-4-methylpiperazine. The antihistaminic activity of piperazines is reduced if halogen is introduced at 2 or 3 position of phenylring ring structures.

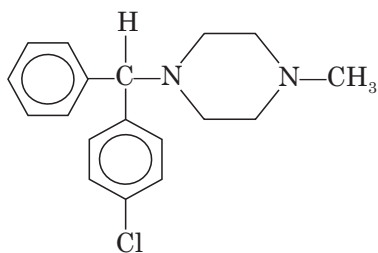

2. **Synthesis.** Chlorcyclizine is prepared by condensation of p-chlorobenzhydryl chloride with N-methylpiperazine.

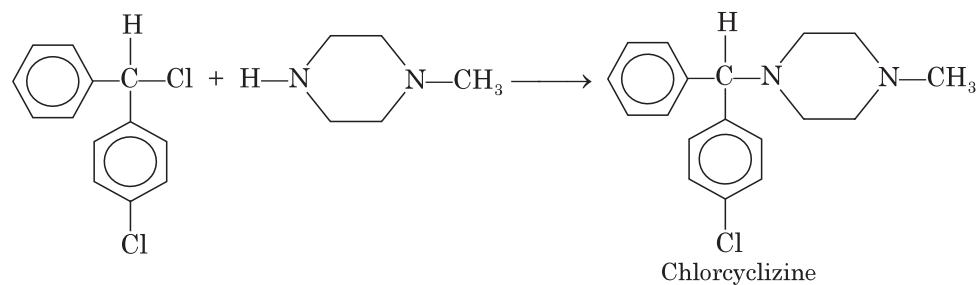

3. **Uses.** Chlorcyclizine has antihistaminic activity. It is used to treat urticaria, hay fever and other allergic conditions.

MECLIZINE

1. **Chemistry.** Meclizine is a piperazine derivative. Meclizine occurs as hydrochloride salt. It is 1-(p-chlorobenzhydryl)-4-(m-methylbenzyl) piperazine.

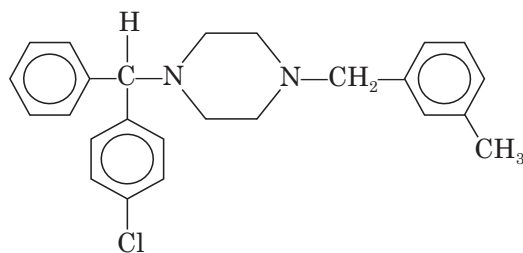

2. **Properties.** Meclizine hydrochloride is water-insoluble, tasteless, white or slightly yellowish crystalline powder.

3. **Synthesis.** It is synthesized by alkylation of p-chloro analog of monosubstituted piperazine with *m*-methylbenzyl chloride.

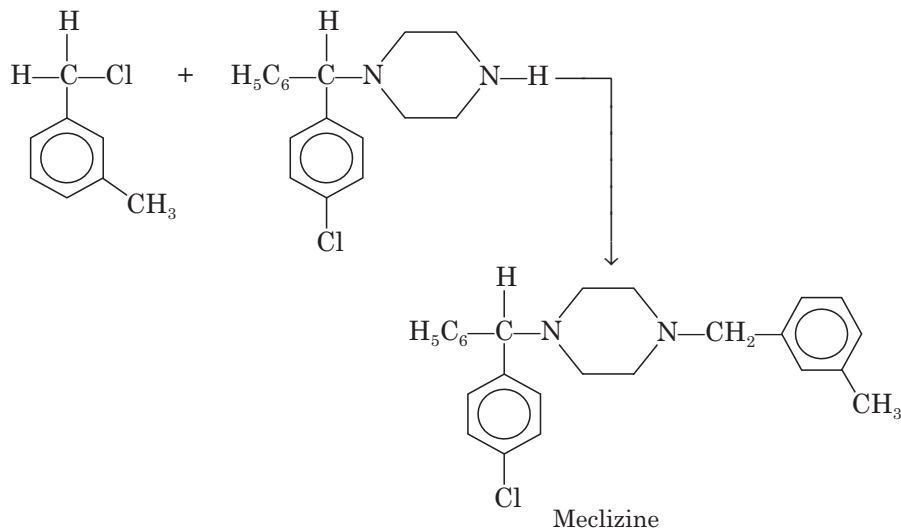

4. Uses :

- (i) Meclizine has moderate antihistaminic activity.
- (ii) It is also used to treat nausea and vomiting.

Bucizine

1. Chemistry. Bucizine is another piperazine derivative. It is 1-(*p*-tert butylbenzyl)-4-(*p*-chloro- α -phenylbenzyl) piperazine. Bucizine occurs as hydrochloride salt.

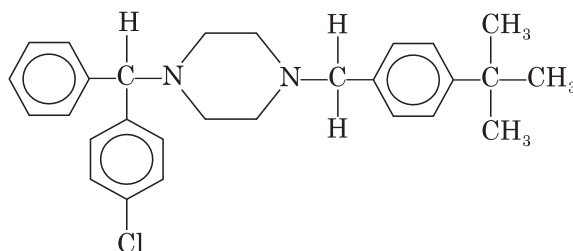

2. Properties. Bucizine hydrochloride is white or slightly yellow colored, crystalline, water insoluble powder.

3. Synthesis. Condensation of *p*-chloro analog of monosubstituted piperazine with *p*-tertiary butylbenzyl chloride gives buclizine.

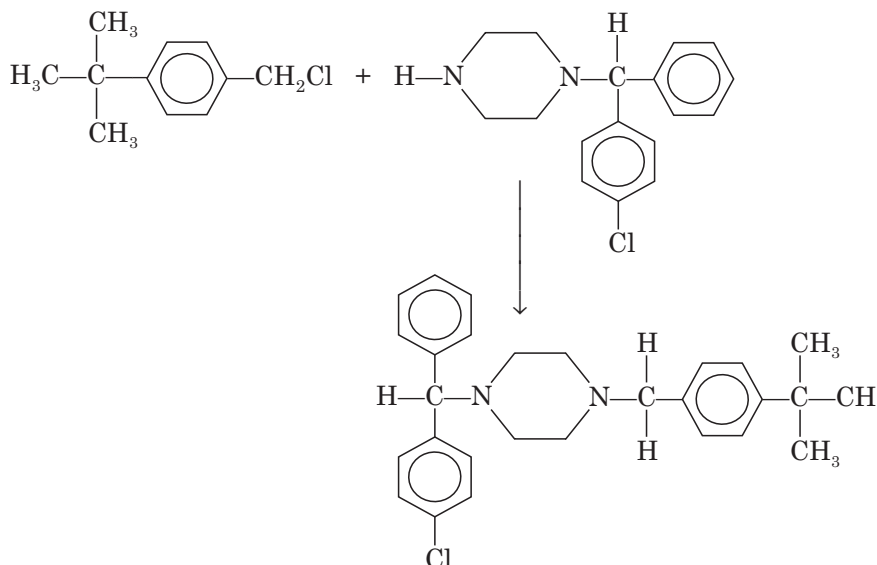

4. Uses. Bucizine has antihistaminic and antiemetic properties.

Debenzocycloheptenes

- (i) Debenzocycloheptenes possess H_1 antihistaminic activity.
- (ii) Debenzocycloheptenes are phenothiazine analogues. The sulfur atom of phenothiazine nucleus is replaced by an isosteric vinyl group ($-\text{CH}=\text{CH}-$) or a saturated ethyl bridge ($-\text{CH}_2-\text{CH}_2-$).
- (iii) A sp^2 hybridised carbon atom replaces the nitrogen of phenothiazine.
Ex: Cyprohepadine, azatadine.

Cyproheptadine

Cyproheptadine is a histamine H_1 -receptor and serotonin antagonist. It occurs as hydrochloride salt. Chemically it is 4-(5H-dibenzo[a,b]cyclohepten-5-ylidene)-1-methylpiperidine. Cyproheptadine hydrochloride is white to slightly yellow, odorless, crystalline powder.

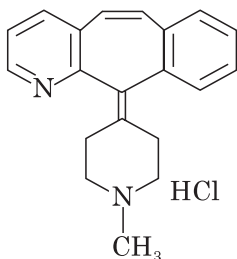

The following steps are involved to synthesize cyproheptadine:

(a) Ketone is brominated with N-bromosuccinimide, followed by debrominated with triethylamine to get an alkene

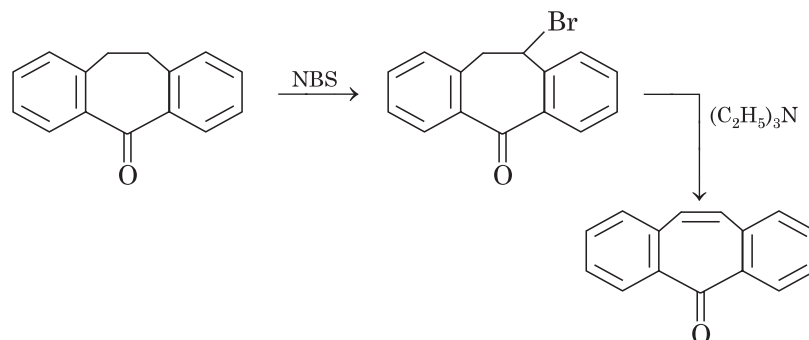

(b) Alkene reacts with N-methyl-4-piperidyl magnesium chloride (Grignard reagent) to yield a complex which is treated with HCl to get cyproheptadine HCl.

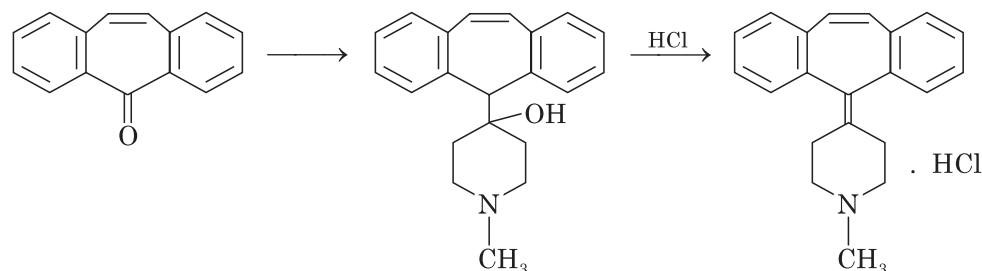

Cyproheptadine is used for the symptomatic relief of hypersensitivity reactions and in pruritic skin disorders. It is also used to treat migraine, anorexia and diarrhoea of carcinoid syndrome.

Azatadine

1. **Chemistry.** Azatadine is chemically related to cyproheptadine. It differs from cyproheptadine in having of pyridine ring instead of benzene ring. Azatadine is white crystalline water-soluble powder occurs as maleate salt. Chemically azatadine is 6,11-dihydro-11 (1-methyl-4-piperidylidene)-5H-benzo(5,6)-cycloheptal (1, 2-b) pyridine.

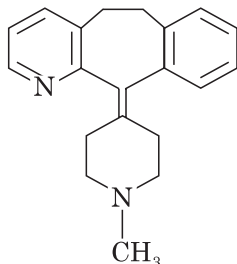
**Uses:**

- (i) It is used as an antihistaminic agent to treat perennial and seasonal allergic rhinitis and chronic urticaria
- (ii) It also possesses anticholinergic, antiserotonin and sedative effects

MISCELLANEOUS ANTIHISTAMINES**Phenindamine**

Chemistry. Phenindamine occurs as tartarate salt. Chemically it is 2,3,4,9-tetrahydro-2-methyl-9-phenyl-1H-indeno [2,1-c] pyridine.

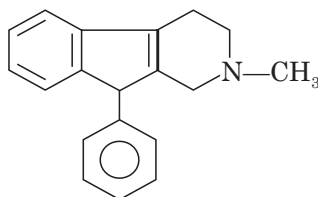

Characters. Phenindamine tartarate is odorless, creamy white, water-soluble powder. The solutions of phenindamine tartarate are slightly acidic to litmus.

Uses. Phenindamine is used for the treatment of hayfever, allergic rhinitis and other upper respiratory allergies.

Dimethindene

Chemistry. Dimethindene is an indene derivative occurs as maleate. Chemically, it is 2-[1-[2-[2-(dimethylamino)ethyl]inden-3-yl] ethyl] pyridine. Dimethindene is synthesized by adding 1-(2-pyridyl)ethyl lithium to 2-[2-(dimethyl amino)ethyl] indan-1-one.

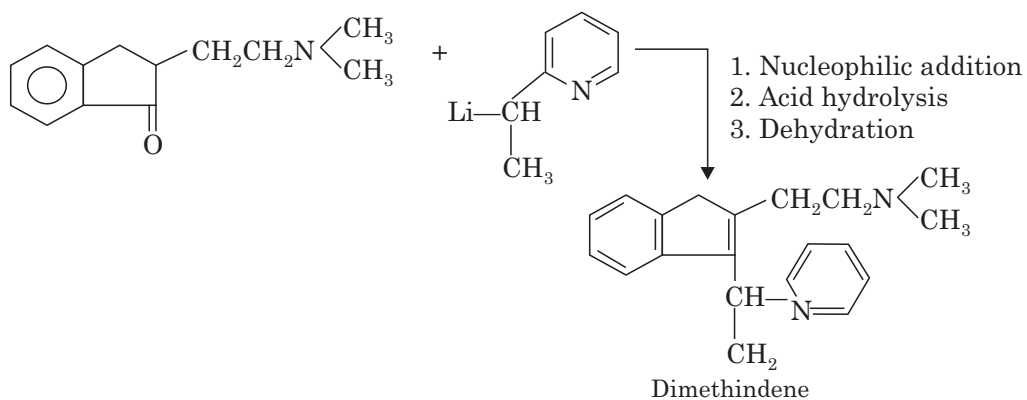

2. **Properties.** Dimethindene maleate is white, characteristic odor, crystalline powder. It is freely soluble in methanol, chloroform but slightly soluble in water and is sensitive to light.

3. **Uses.** It is a potent antihistaminic agent used in perennial and seasonal allergic rhinitis, vasomotor rhinitis, and allergic conjunctivitis.

Antazoline

1. **Chemistry.** Antazoline is an imidazoline derivative. Antazoline is 2-[(N-benzylanilino)methyl]-2-imidazoline. It is synthesized by alkylation of benzylaniline with halogenated imidazoline

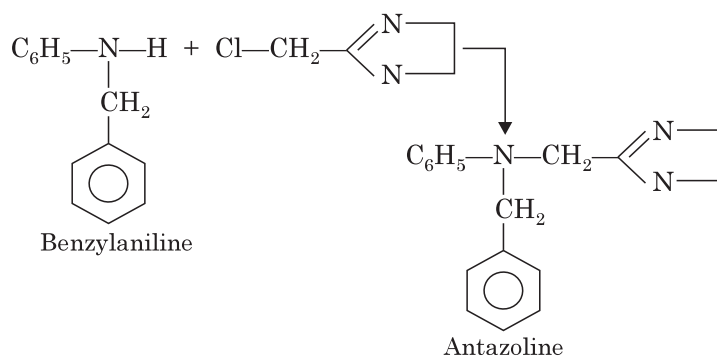

2. **Characters.** It occurs as phosphate salt. Antazoline phosphate is white, bitter taste, crystalline powder. It is soluble in water.

3. **Uses.** Antazoline is histamine H_1 -receptor antagonist used for the treatment of rhinitis and conjunctivitis.

Diphenylpyraline

1. **Chemistry.** Diphenylpyraline is a piperidine derivative, which occurs as hydrochloride salt. Chemically it is 4-(diphenylmethoxy)-1-methylpiperidine.

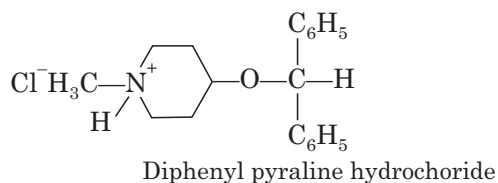

2. **Characters.** Diphenylpyraline hydrochloride is water-soluble white crystalline powder. It is soluble in alcohol but insoluble in ether and benzene.

3. **Synthesis.** Diphenylpyraline is synthesized by refluxing the mixture of 1-methyl-4-piperidinol and benzhydryl bromide.

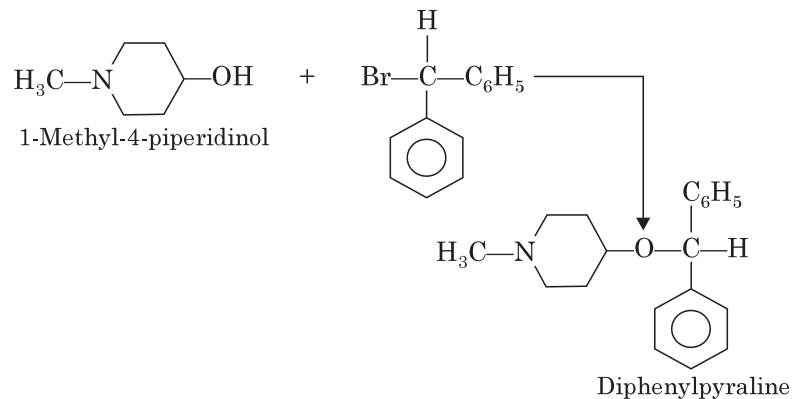

4. Uses :

(i) It is used as an antihistaminic agent. It is effective for perennial and seasonal allergic rhinitis, vasomotor rhinitis, allergic conjunctivitis.

(ii) It also possesses anticholinergic and sedative effects.

Ebastine

Ebastine is a potent, long acting antihistaminic. It acts against both early and late phase without any adverse effect on the cardiovascular and central nervous system. Ebastine is a piperidine derivative. Chemically ebastine is 4-tertiarybutyl 1-(4-(4-diphenyl methoxy piperidine) butyrophenone).

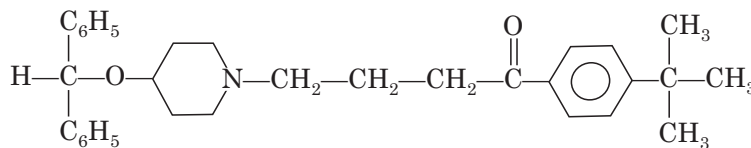

Mechanism of action:

Ebastine and its active metabolite carebastine, are selective histamine H_1 peripheral receptor antagonists devoid of untoward CNS action and anticholinergic effects. Because of low lipophilicity and greater molecular size it has limited ability to cross the blood brain barrier, allowing an effective blockage of H_1 receptors in peripheral tissues without important central side effects.

Uses: (i) Allergic rhinitis (seasonal and perennial)

(ii) Idiopathic chronic urticaria.

THERAPEUTIC APPLICATIONS OF ANTI-HISTAMINES

1. All antihistamines are of potential value in the treatment of nasal allergies, particularly seasonal allergic rhinitis (hay fever), and they may be of some value in vasomotor rhinitis. They reduce rhinorrhoea and sneezing but are usually less effective for nasal congestion. Antihistamines are used topically in the eye, in the nose, and on the skin.

2. Oral antihistamines are also of some value in preventing urticaria and are used to treat urticarial rashes, pruritus, and insect bites and stings; they are also used in drug allergies. Injections of chlorpheniramine or promethazine are used as an adjunct to adrenaline in the emergency treatment of anaphylaxis and angioedema. Some antihistamines (including cinnarizine, cyclizine, and promethazine teoclate) are used to control nausea and vomiting. Buclizine is included as an anti-emetic in a preparation for migraine.

SECOND GENERATION ANTIHISTAMINES

The second-generation antihistamines bind only to peripheral H_1 receptors, and reduce allergic response with little or no sedation. They have no central action, and are used only for treatment of allergic reactions. These drugs have prolonged antihistaminic effects and also binds to muscarinic, and adrenergic receptors. These are divided into two chemical classes.

(i) piperazine derivative. *Ex:* Cetirizine

Cetirizine has a slight sedative effect.

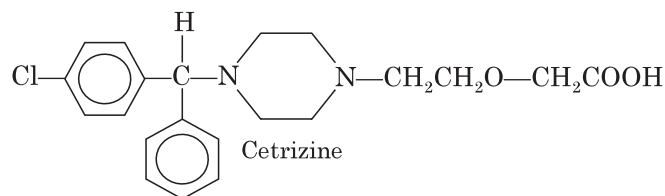

(ii) piperidine derivatives. *Ex:* Loratidine, fexofenadine

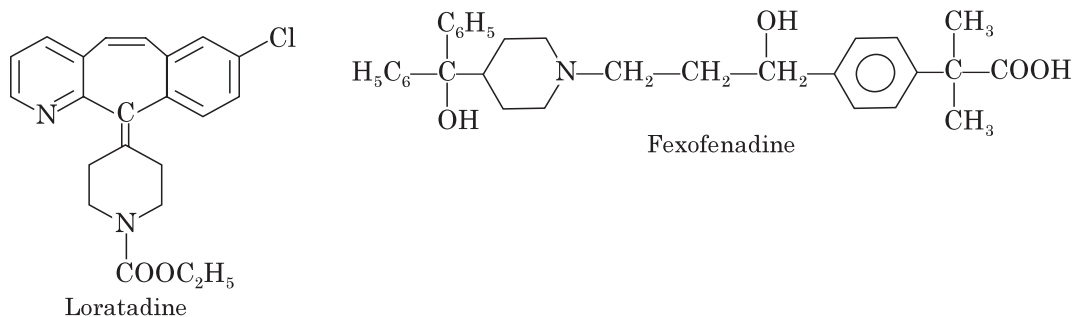

Loratidine and fexofenadine are members of the piperidine class and are essentially non-sedating.

HISTAMINE H_2 -RECEPTOR BLOCKERS

Some of the histamine responses (dilation of capillaries, increasing the rate and force of heart contraction, increasing gastric acid secretion) are exclusively mediated through H_2 receptors. The classical antihistamines are unable to inhibit these responses hence H_2 receptor-blocking drugs were introduced. H_2 -Receptor antagonists are drugs used to block histamine H_2 receptors

reversibly and inhibit H_2 -receptor mediated responses. They are used to treat gastric ulcers as they block gastric-acid and enzyme secretion. Gastric acid secretion by parietal (oxyntic) cell is not blocked by antihistamines acting on H_1 receptors. They have little affinity for H_1 -receptors.

1. **Cimetidine.** Cimetidine is a H_2 -histamine receptor antagonist. It inhibits basal as well as meal stimulated gastric secretion. Cimetidine also inhibits cytochrome P450. Cimetidine acts on H_2 -receptors in the stomach, blood vessels and thus inhibits gastric acid secretion. It is used in the treatment of ulcers such as duodenal ulcer, non-malignant ulcer etc.

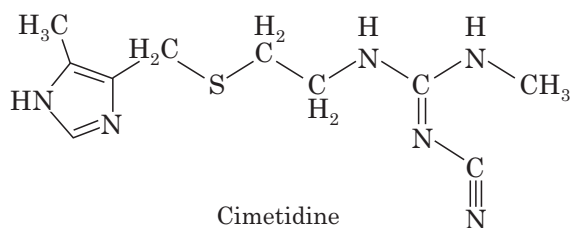

Synthesis of cimetidine:

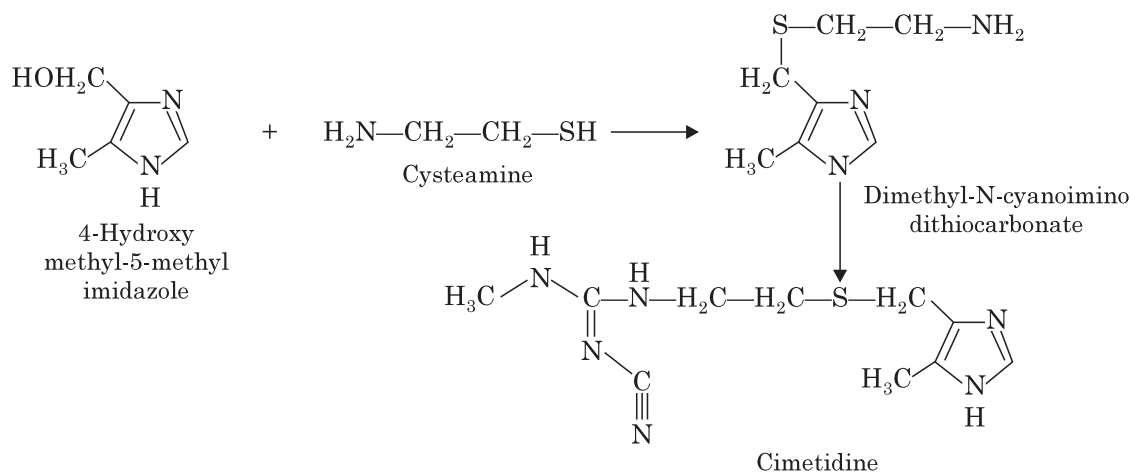

2. **Ranitidine.** Ranitidine is another H_2 -histamine receptor antagonist. It is 5-10 times more potent than cimetidine. Ranitidine was developed because it binds less to cytochrome P450 and has fewer side effects and acts longer.

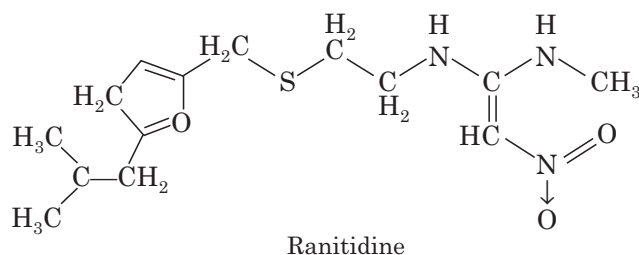

Synthesis. Ranitidine is synthesised by the following route:

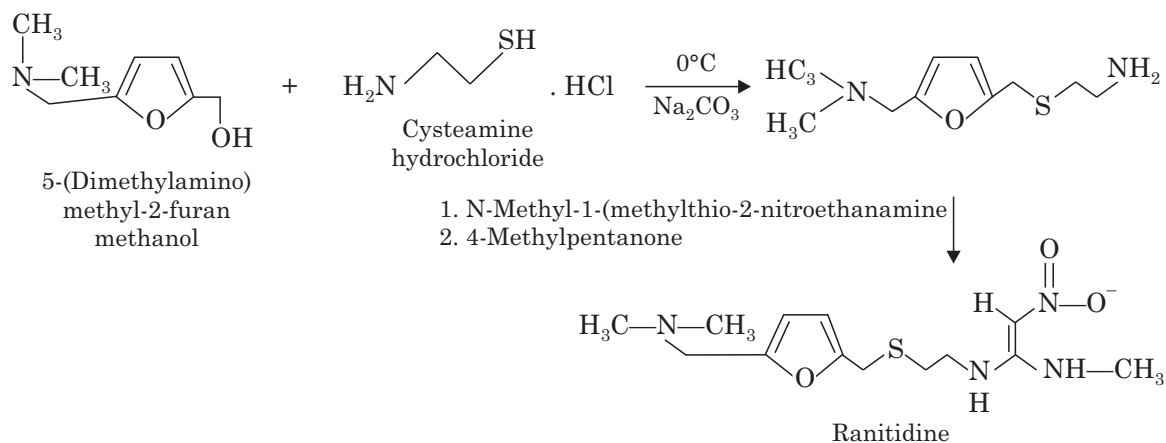

Famotidine. Imidazole moiety was replaced by thiazole to get famotidine. Famotidine is a newer H_2 -histamine receptor antagonist. It is more effective than ranitidine, less than 45% of an oral dose is absorbed.

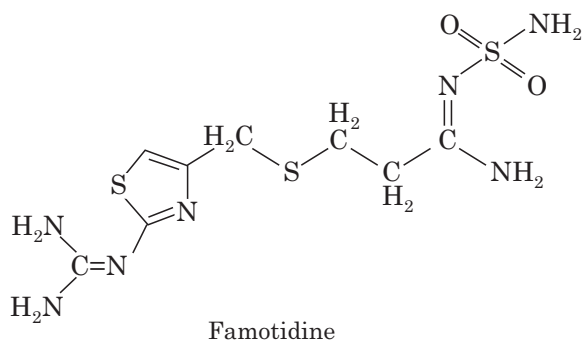

SIDE EFFECTS OF ANTIHISTAMINES

1. Central nervous system reactions include drowsiness, sedation, dizziness, faintness, disturbed coordination, lassitude, confusion, restlessness, excitation, tremor, seizures, headache, insomnia, euphoria, blurred vision, hallucinations, disorientation, disturbing dreams/nightmares, schizophrenic-like reactions, weakness, vertigo, hysteria, nerve pain, and convulsions. Overdoses may cause involuntary movements.
2. Gastrointestinal problems include increased appetite, decreased appetite, nausea, vomiting, diarrhea, and constipation.
3. Hematologic reactions are rare, but may be severe. These include anemia, or breakdown of red blood cells; reduced platelets; reduced white cells; and bone marrow failure.
4. A large number of additional reactions have been reported. Not all apply to every drug, and some reactions may not be drug related. Some of the other adverse effects are chest tightness; wheezing; nasal stuffiness; dry mouth, nose and throat; sore throat; respiratory depression; sneezing; and a burning sensation in the nose.

15

Narcotic Analgesics

INTRODUCTION

Narcotic agents are potent analgesics, which are effective for the relief of severe pain. They are selective central nervous system depressants used to relieve pain. In therapeutic doses, narcotic analgesics can cause respiratory depression, nausea, and drowsiness. Long-term administration of narcotics produces tolerance, psychic, and physical dependence called addiction.

CLASSIFICATION OF NARCOTIC ANALGESICS

Narcotic analgesics will be classified on the basis of their structural derivation from morphine. They may be classified into following categories:

1. Natural alkaloids of opium: Morphine and codeine.
2. Semisynthetic analogs. *e.g.*: Hydromorphone, oxycodone, oxycodone.
3. Synthetic agents *Ex*: Meperidine, levorphanol, methadone, sufentanil, alfentanil, fentanyl, remifentanyl, levomethadyl.

THE OPIUM ALKALOIDS

Opium ranked as the most effective pain-relieving drug until the development of morphine in the early 1800's. Opium was also used to stop coughing and diarrhoea, to ease worry, and to cause drowsiness. Opiates serve many of the same purposes today. Opium contains two series of alkaloids. They are:

- (a) Phenanthrene group: Morphine, Codeine, Thebaine.
- (b) Benzylisoquinoline group: Papaverine, Noscapine.

BIOCHEMICAL MECHANISM OF ACTION OF OPIATES

- The endogenous peptides found in central nervous system (CNS) and gastrointestinal tract (endorphins, enkephalins, dynorphins) can decrease pain (analgesia), produce euphoria, drowsiness, depress respiration, depress the cough reflex, depress gastrointestinal muscle activity.
- Opiates activate endorphin or enkephalin receptors, which decrease the activity of other neurons that transmit the sensation of pain.
- At least 5 types of opiate receptors identified.

OPIATE RECEPTORS

Analgesics are primarily employed for their ability to reduce the perception of pain impulses by the CNS. Analgesic activity is mediated by opiate receptors in the CNS. Five major categories of opioid receptors are known: mu (μ), kappa (κ), sigma (σ), delta (δ), and epsilon (ϵ). Narcotic drugs occupy the same receptors as endogenous opioid peptides (enkephalins or endorphins). The actions of the narcotic analgesics now available can be defined by their activity at three specific opiate receptor types: mu (μ), kappa (κ) and delta (δ).

- μ -(mu) receptors mediate analgesia, euphoria, respiratory and physical depression, miosis, and reduced gastrointestinal motility. These receptors have been further subtyped as μ_1 , which are supraspinal and mediate analgesia, and μ_2 which mediate respiratory depression. The μ_1 receptor is morphine selective.
- δ -(delta) receptors mediate spinal and supraspinal analgesia, dysphoria, psychotomimetic effects (*e.g.*, hallucinations), and respiratory and vasomotor stimulation caused by drugs with antagonist activity. These receptors have been subtyped as δ_1 and δ_2 and are thought to be relatively unimportant in terms of analgesia.
- κ -(kappa) receptors mediate pentazocine like spinal analgesia, sedation, miosis and respiratory depression and dysphoria. These receptors have been further subtyped as κ_1 which mediates spinal analgesia, κ_3 which mediates supraspinal analgesia and κ_2 whose function is unknown. These receptors are proposed to mediate a sedating analgesia with reduced addiction liability and respiratory depression.

MORPHINE AND MORPHINE DERIVATIVES

The prototypic narcotic analgesic is (-)-morphine, the principal alkaloid obtained from the opium poppy (*Papaver somniferum*). Morphine was isolated as a pure alkaloid by a German pharmacist, Serturmer in 1803.

Chemistry of Morphine

The morphine molecule has the following important structural features:

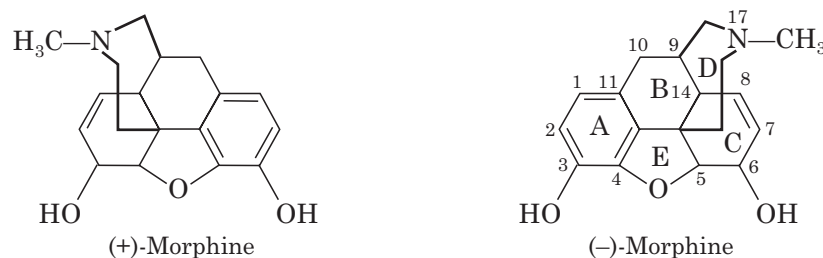

1. A rigid pentacyclic structure consisting of a benzene ring (A), two partially unsaturated cyclohexane rings (B and C), a piperidine ring (D) and a dihydrofuran ring (E). Rings A, B and C are the phenanthrene ring system. This ring system has little conformational flexibility. Ring A and its 3-hydroxyl group is an important structural feature for analgesic activity. Removal of the 3-OH group reduces analgesic activity by 10-fold.
2. Two hydroxyl functional groups, a C3-phenolic OH (pKa 9.9) and a C6-allylic OH.
3. An ether linkage between C4 and C5.
4. Unsaturation between C7 and C8.
5. A basic, 3°-amine function at position 17.

6. 5 Centers of chirality (C5, C6, C9, C13 and C14) with morphine exhibiting a high degree of stereoselectivity of analgesic action. Only (-)-morphine is active.

Morphine as well as a majority of narcotic analgesics are functionally basic compounds both pharmaceutically (dosage forms) and physiologically due to the presence of tertiary amine functions. Hence, morphine exists as a cation at physiologic pH, and readily forms salts with appropriate acids (commercial products are sulfate and HCl):

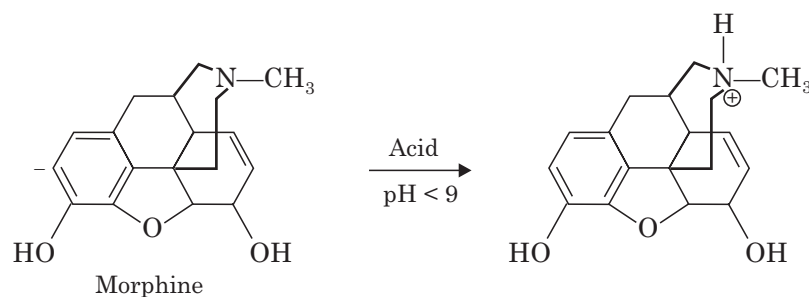

Modified Morphines : Ring A Analogues

Ring A and its 3-hydroxyl group is an important structural feature for analgesic activity. Removal of the 3-OH group reduces analgesic activity by 10-fold.

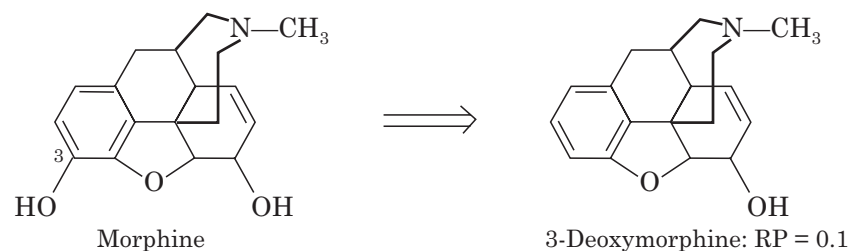

Altering the C-3 OH by etherification as shown by the derivatives below reduces narcotic analgesic activity.

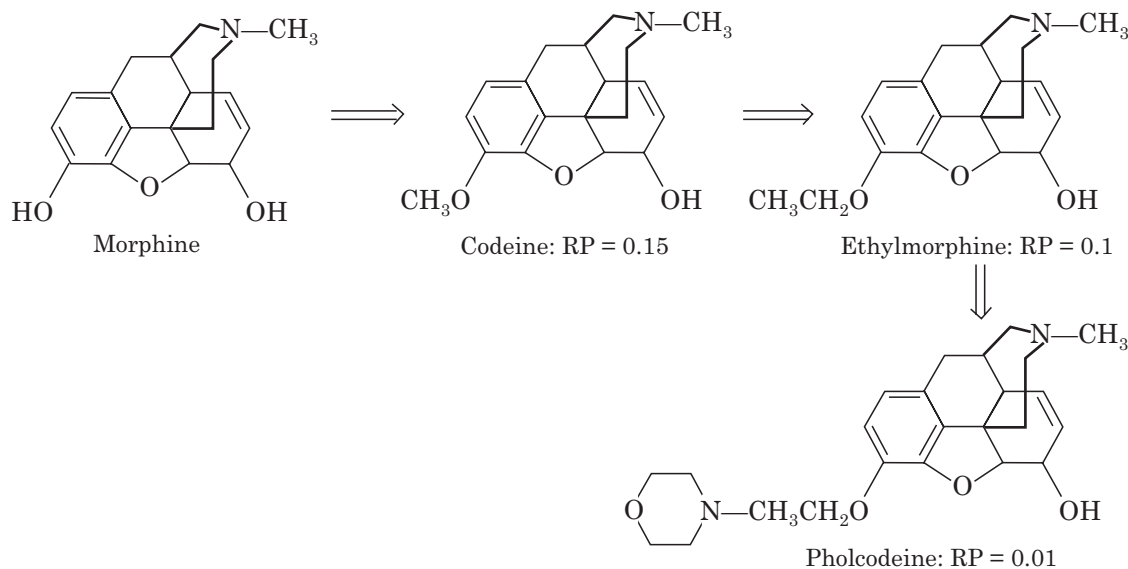

Heroin

Esterification (acetylation) of both the 3- and 6-OH groups yields heroin, which is more lipophilic and more potent. The primary factor involved in increased analgesic potency is the increased lipophilicity and distribution to the CNS.

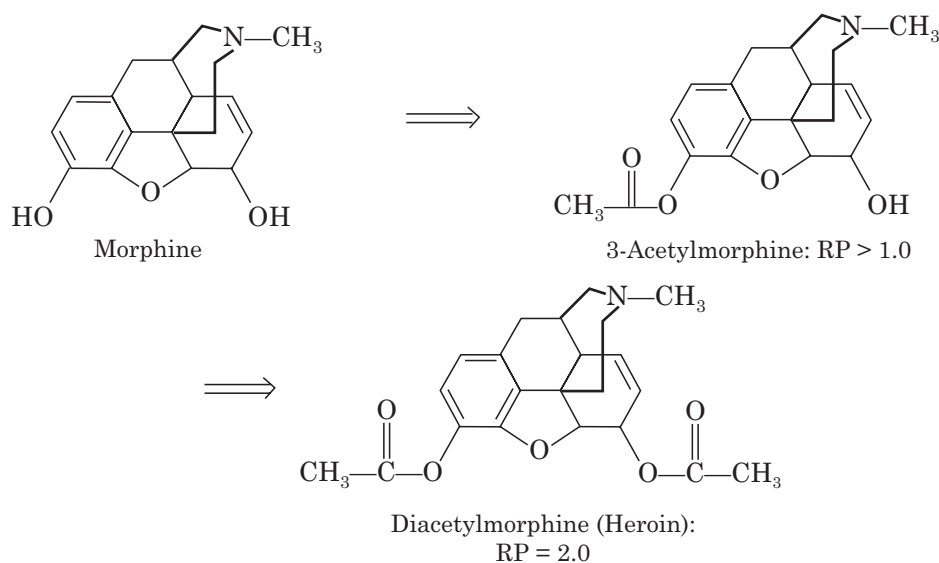

Heroin is synthesized from morphine by a relatively simple esterification reaction of two alcohol (phenol) groups with acetic anhydride. Heroin is much more potent than morphine but without the respiratory depression effect. Acetyl groups are readily removed by metabolism to active morphine. Heroin is official as hydrochloride salt. It occurs as water soluble, white crystalline, bitter taste powder.

Codeine

Conversion of the 3-OH to a 3-OCH₃, yields codeine, reduces activity to 15% of morphine. Codeine is available as a sulfate and phosphate salt and also as the free base and as tablets, elixir and solution for injection. The 3-methoxy group protects the 3-position from glucuronide as occurs with morphine. Codeine is used as an analgesic and antitussive.

Peripherally Modified Morphines: Ring C Analogues

The 6-OH of morphine is not required for analgesic activity as indicated by the relative potencies of the following morphine analogues. Elimination of the 6-OH actually enhances activity. Etherification of this group with relatively small alkyl group also increases activity. Esterification of the 6-OH as in the main hydrolysis metabolite of heroin, also increases analgesic activity. This increased activity appears to result largely from the enhanced lipophilicity of these compounds and their increased ability to penetrate the CNS.

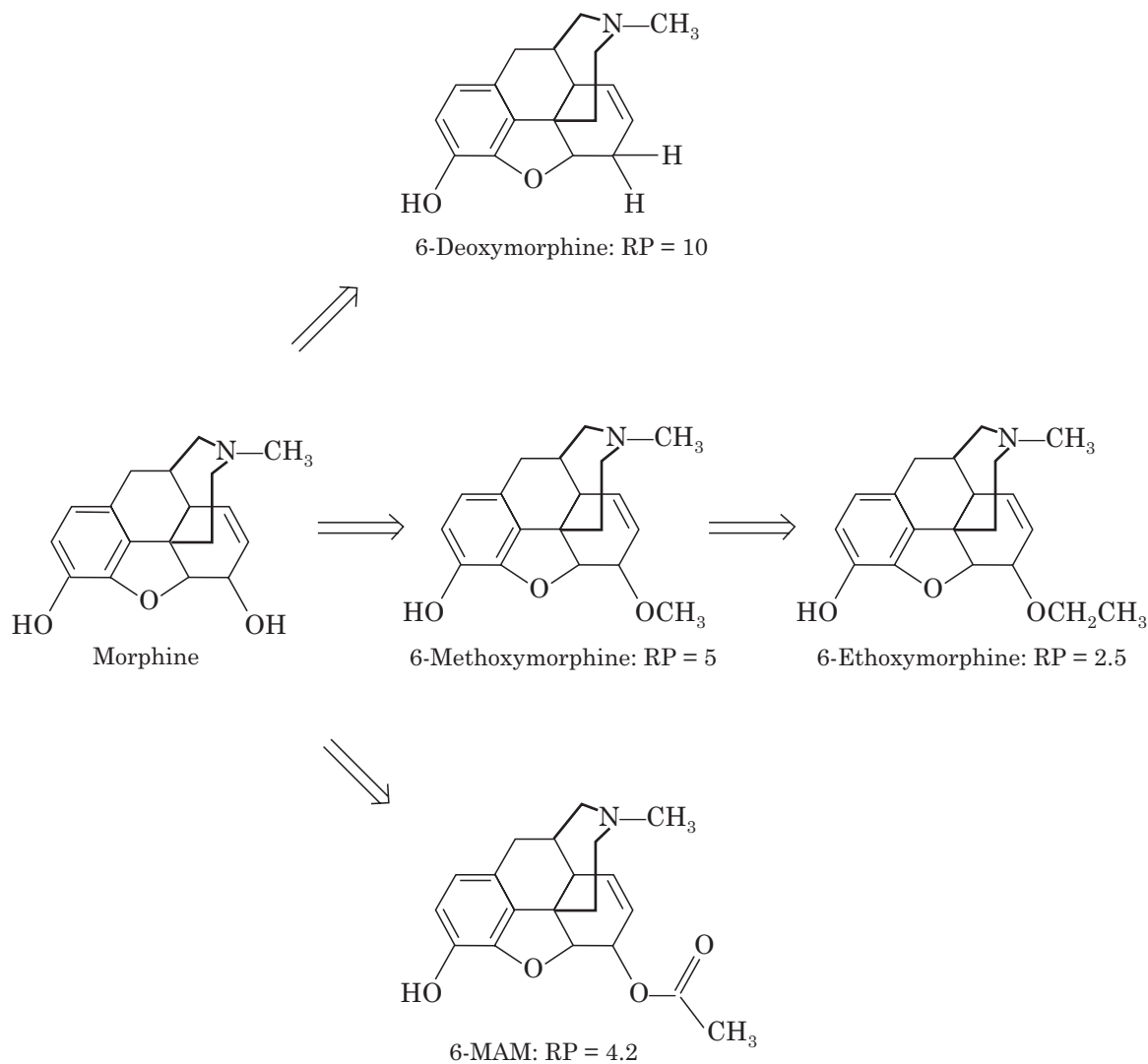

Hydromorphone and oxymorphone. The 7, 8-double bond of morphine also is not required for analgesic activity as indicated by the relative analgesic potency of dihydromorphone. Also, oxidation of the 6-OH of dihydromorphone to yield hydromorphone further increases activity. Substitution of a 14-OH group on the hydromorphone structure as in oxymorphone produces a further increase in analgesic activity (RP = 10). Oxidation of the 6-OH of morphine directly as in morphine (without reduction of the 7, 8-double bond) does not significantly alter analgesic activity. Hydromorphone is available as the HCl salt in tablets, liquid, suppository and injectable.

Oxymorphone is available as the HCl salt in a suppository and as an injectable.

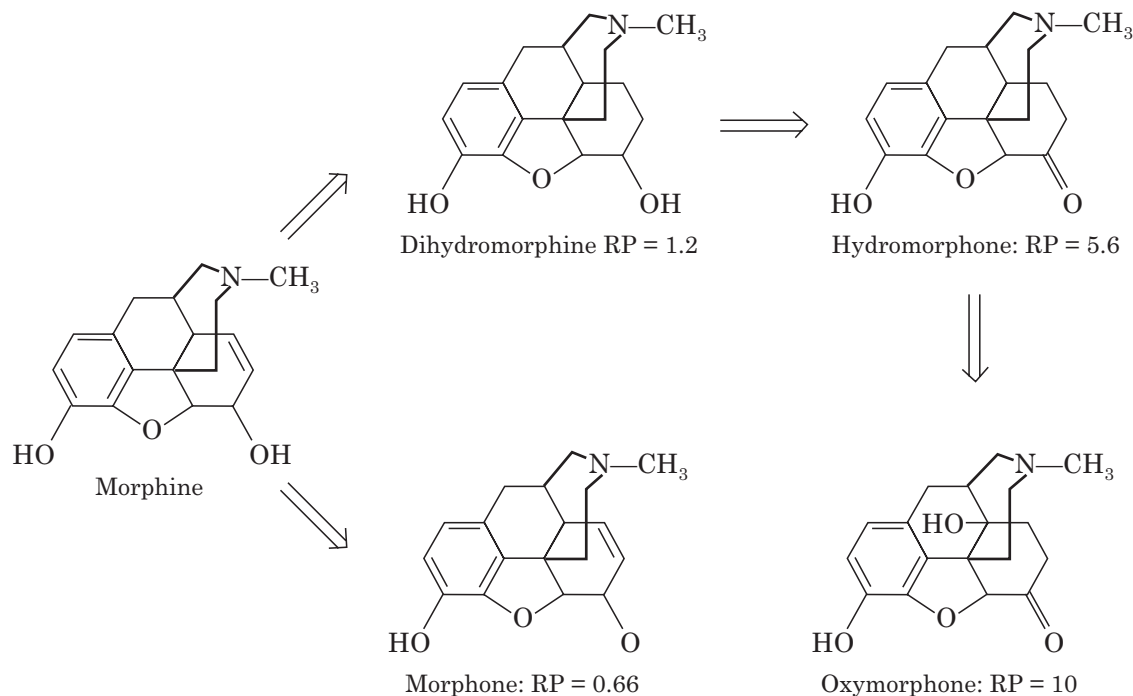

Dihydrocodeine and Oxycodone. Reduction of codeine's 7, 8-double bond as in dihydrocodeine increases activity relative to codeine. Oxidation of the 6-OH of dihydrocodeine as in hydrocodone results in a further increase in activity, and 14-OH substitution produces a further increase in analgesic activity. Hydrocodone is available as the bitartrate salt in tablets and syrups. It has analgesic and antitussive activity. Oxycodone is available as the HCl salt in tablets and capsules. It has analgesic and antitussive activity.

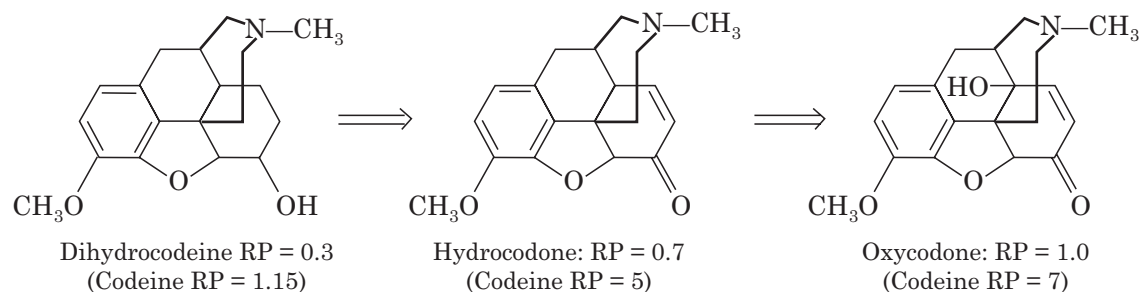

Peripherally Modified Morphines: Ring D Analogues and the Tertiary Amine Function :

Replacement of morphine's N-methyl group by a hydrogen atom as in normorphine reduces analgesic activity to 1/8th that of morphine. Much of this decrease is due to increased polarity resulting in reduced blood brain barrier translocation to the CNS. Replacement of morphine's N-methyl group with an allyl group ($-\text{CH}_2-\text{CH}=\text{CH}_2$), a methylcyclopropyl group or a methylcyclobutyl group results in the emergence of opiate receptor antagonist activity.

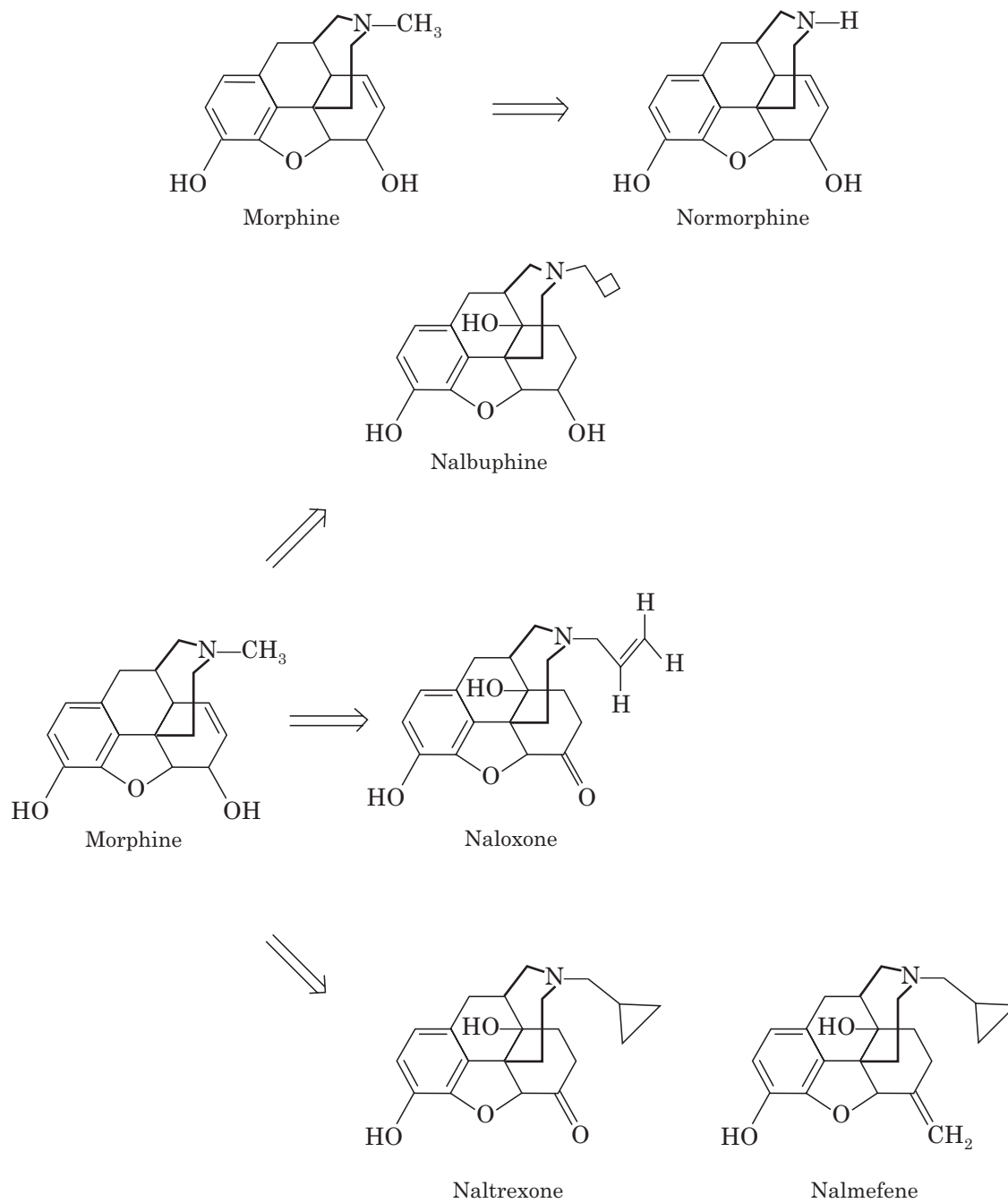

Replacement of the potent narcotic agonist oxymorphone's N-methyl group with an allyl group ($-\text{CH}_2-\text{CH}=\text{CH}_2$), a methylcyclopropyl group or a methylcyclobutyl group also results in the emergence of opiate receptor antagonist activity. *Ex:* naloxone HCl, naltrexone HCl and nalmefene.

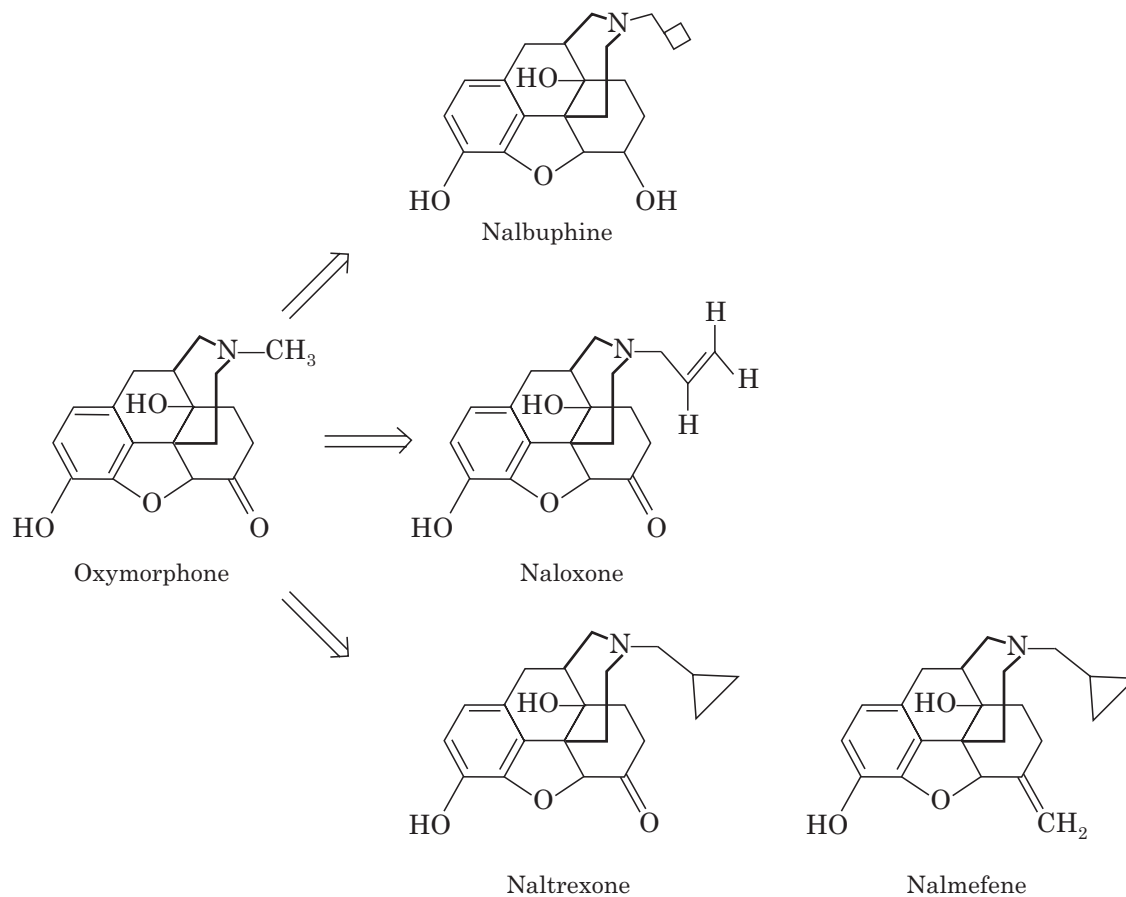

Peripherally Modified Morphines : The Thebaines. Adding a sixth ring across carbons 6 and 14 of the C ring of morphine yields thebaine compounds such as etorphine which are extremely potent analgesics. Replacement of the N-methyl group of the thebaines with a methylcyclopropyl group yields compounds with mixed agonist/antagonist or partial agonist activity.

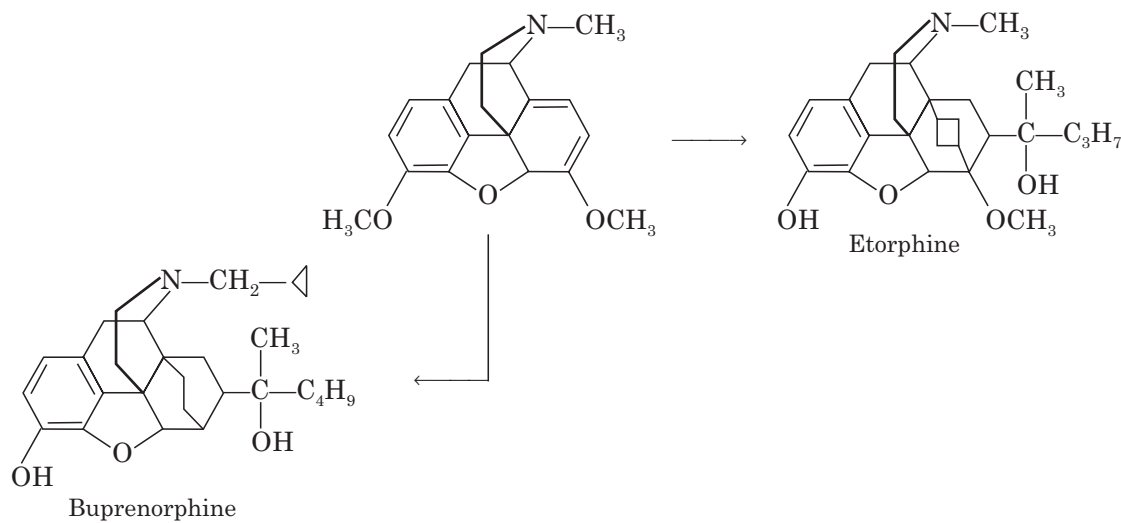

THERAPEUTIC USES OF OPIATES

1. **Analgesia.** reduces perception and emotional response to pain.
2. **Intestinal disorders.** reduce diarrhea and avoid dehydration.
3. **Antitussive.** cough suppressant (codeine).

ADVERSE EFFECTS OF OPIATES

1. **Respiratory depression.** Medulla in brainstem becomes less responsive to carbon dioxide in blood; additive with other depressants.
2. Drowsiness and decreased mental alertness.
3. Constipation.
4. Nausea and vomiting.
5. **Tolerance.** Cross tolerance with similar opiates.
6. Acute Toxicity.
7. **Narcotic Triad.** Coma, respiratory depression, pin point pupils
8. **Physical dependence.** "flu-like" withdrawal effects; rarely life threatening. Severely addicted subjects report significant pain.
9. **Psychological dependence.** Positive reinforcement from euphoria and negative reinforcement from rapid appearance of withdrawal symptoms.

SYNTHETIC NARCOTIC ANALGESICS

A systematic search was initiated in 1929 under the direction of the committee on Drug Addiction of the U.S. National Research Council to separate analgesic and dependence liability properties in synthetic analogues of morphine alkaloids. Some important synthetic analgesics are described below :

Meperidine (Pethidine). Meperidine is the most common substitute for morphine and is 10 times less potent than morphine. Meperidine belongs to phenylpiperidine group of synthetic opioids. Chemically it is 1-methyl-4-phenyl-4-piperidine carboxylate. It can be synthesized from by the following steps:

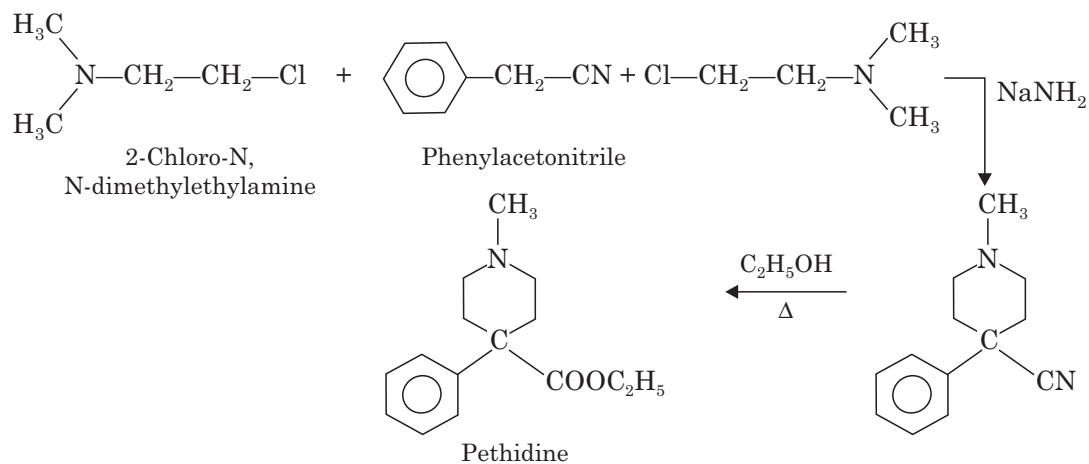

Meperidine occurs as odorless, white colored crystalline powder. It exerts several pharmacological effects: analgesic, local anesthetic, and mild antihistaminic. This multiple activity may be explained by its structural resemblance to morphine, atropine, and histamine. It has shorter duration of action than morphine and is frequently used by dentists.

Fentanyl

Fentanyl is *N*-(1-phenylethyl-4-piperidiny) propionanilide. Fentanyl is a very potent synthetic opiate, which can be used, as an analgesic. It is structurally related to phenylpiperidines (*e.g.* meperidine) and produces strong analgesia, similar to morphine.

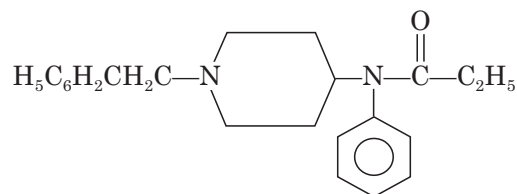

Fentanyl is 80 times more potent than morphine as analgesic. It is used as an aid for induction and maintenance of inhalation anaesthesia.

Methadone. Methadone is a synthetic narcotic used in the treatment of some heroin addicts. It is more active and more toxic than morphine. Methadone shows optical activity. Of the optical isomers, *l*-methadone is a more potent analgesic while *d*-isomer is antitussive. It can be used for the relief of many types of pain. In addition it is used as a narcotic substitute in addiction treatment because it prevents morphine abstinence syndrome.

German chemists synthesized methadone during World War II when the United States and other allies cut off their opium supply. Synthesis of methadone involves the following steps:

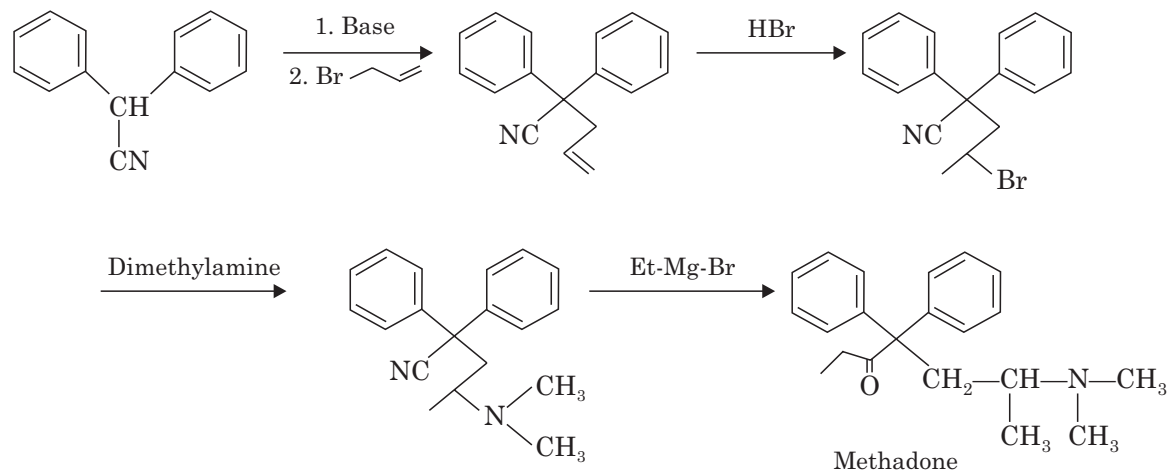

Buprenorphine

Buprenorphine is an opioid with prolonged duration of action, ranging from 6 to 12 hours. High dosages can negate the analgesic effect, and complications from repeat high dosage include hematuria and gastrointestinal bleeding. At lower doses buprenorphine is an effective analgesic in rodents.

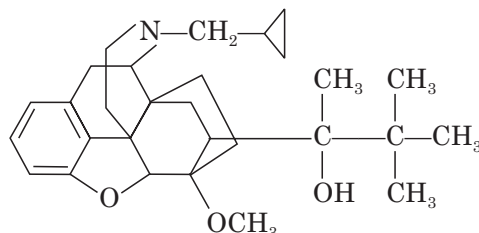

Loperamide

Loperamide is 4-(4-chlorophenyl)-4-hydroxy-N,N-dimethyl- α , α -diphenyl-1-piperidinebutyramide.

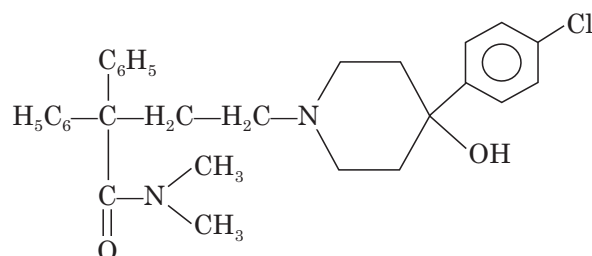

Loperamide slows intestinal motility by acting on the nerve endings and/or intramural ganglia embedded in the intestinal wall. The prolonged retention of the feces in the intestine results in reducing the volume of the stools, increasing viscosity, and decreasing fluid and electrolyte loss.

Symptomatic relief of acute nonspecific diarrhoea and of chronic diarrhoea associated with inflammatory bowel disease.

Nefopam

Nefopam is 3,4,5,6-tetrahydro-5-methyl-1-phenyl-1H-2,5-benzoxazocine.

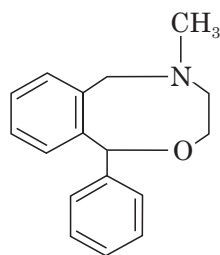

Nefopam is novel, centrally acting, non-narcotic analgesic with a strong and rapid effect. It is used for the relief of moderate to severe pain caused by injury, surgery and cancer. It may also be used for severe toothache. It reduces the perception of pain by the brain but its precise mechanism of action is unclear. Unlike most analgesics that act on the brain, nefopam does not interfere with breathing or cause dependence or abuse. The drug does, however, have anticholinergic and sympathomimetic actions that may produce nausea, nervousness and a dry mouth.

Propoxyphene hydrochloride

Propoxyphene hydrochloride, is an odorless, white crystalline powder with a bitter taste. It is freely soluble in water. Chemically, it is (2*S*, 3*R*)-(+)-4-(dimethylamino)-3-methyl-1,2-diphenyl-2-butanol propionate hydrochloride.

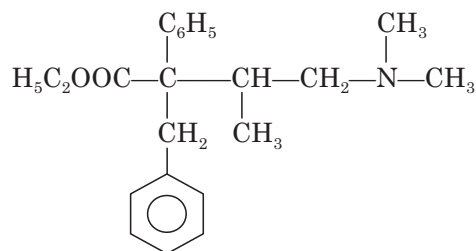

Action. Propoxyphene resembles narcotics with respect to its mechanism and analgesic effect; it is one-half to one-third as potent as codeine. It is devoid of antitussive, anti-inflammatory, or antipyretic activity.

Uses. Propoxyphene is used to relieve mild to moderate pain.

Ethoheptazine. Ethoheptazine is ethyl 1-methyl-4-carbethoxy-4-phenyl-cyclohexanemethanamine.

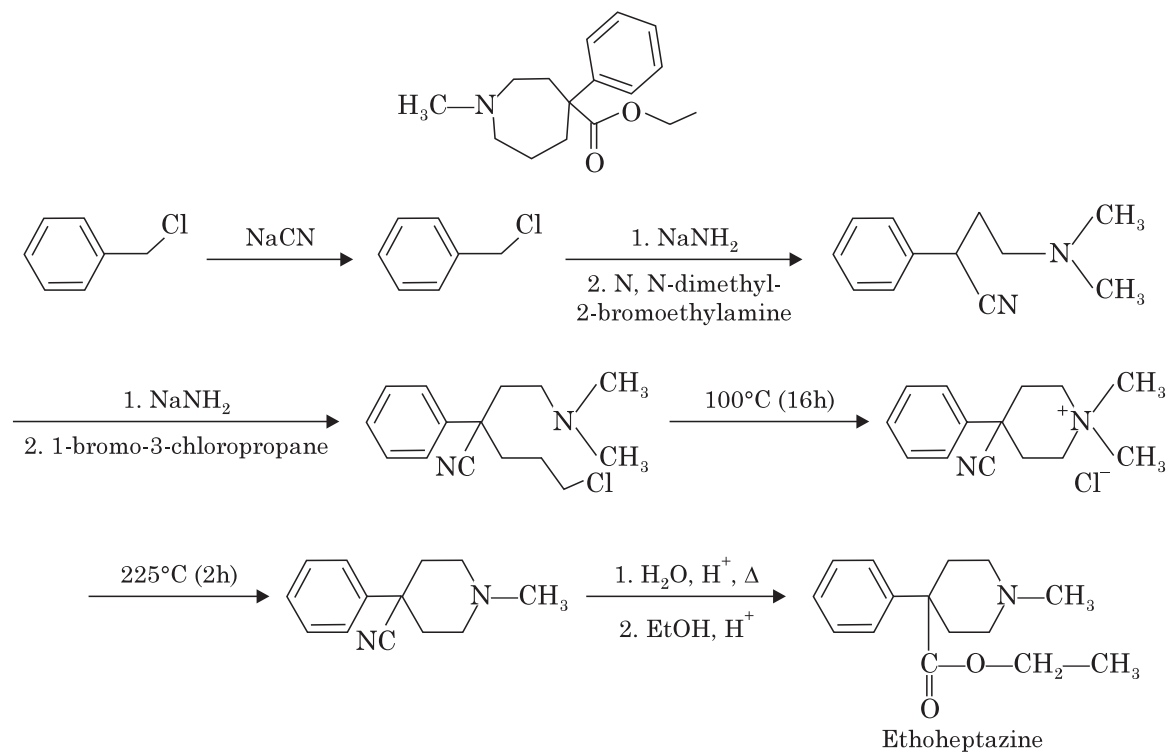

Diphenoxylate

Diphenoxylate is ethyl-1-(3-cyano-3,3-diphenylpropyl)-4-phenylisonipecotate.

Diphenoxylate is a narcotic antidiarrhoeal drug related chemically to loperamide. It reduces bowel contractions and consequently the frequency and fluidity of bowel movements. Although diphenoxylate is chemically related to narcotics, it does not have pain relieving (analgesic) actions like most other narcotics. In higher doses, like other narcotics, diphenoxylate can cause euphoria (elevation of mood) and physical dependence.

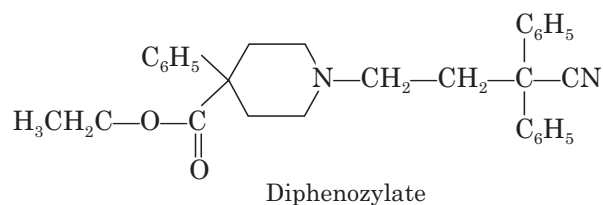

Apomorphine. Apomorphine has similar chemical structure to morphine. It is obtained from morphine by dehydration on heating with HCl.

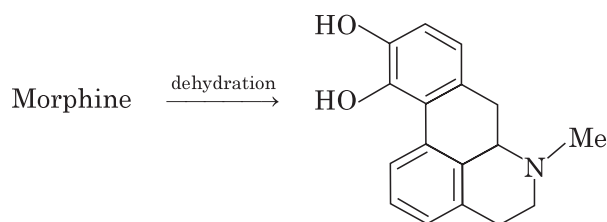

Apomorphine is a stimulant primarily works as a D1 receptor-specific dopamine agonist. Like most dopamine agonists, it is useful in the management of Parkinson's Disease. Apomorphine has been filed with the US Food and Drug Administration for the treatment of erectile dysfunction.

Butorphanol

Butorphanol is five times more potent than morphine. It acts as an agonist on kappa and delta receptors. It is a semisynthetic thebaine derivative with higher lipophilicity. The additional alkyl substitution at C7 suggests an evidence for an additional lipophilic-binding site in opioid receptor.

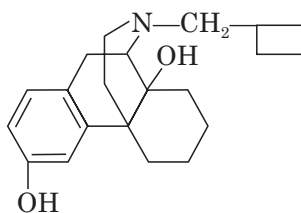

Pentazocine. Pentazocine is a novel drug possessing of both opioid agonistic and antagonistic properties. It presumably acts on kappa receptors to produce analgesia and sedation. It may block μ -receptors also. Like other narcotics it produces analgesia, sedation and respiratory depression.

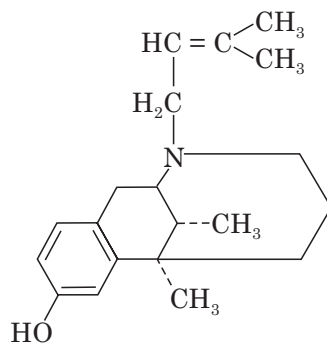

16 Narcotic Antagonists

WHAT ARE NARCOTICS ?

Narcotics are drugs that relieve pain and often induce sleep. The opiates, including opium and drugs derived from opium, such as morphine, codeine, and heroin are narcotics. Narcotics also include certain synthetic chemicals that have a morphine-like action (such as methadone).

WHAT ARE NARCOTIC ANTAGONISTS ?

Narcotic antagonists are drugs which block the “high” and other effects of narcotics. They also precipitate withdrawal symptoms in the narcotic addict. This feature of narcotic antagonists makes them extremely useful in treating overdoses. They are structurally related to morphine with the exception of the group attached to nitrogen hence they act by competing for the same analgesic receptor sites. Research is currently going on to determine the usefulness of antagonists as maintenance drugs. Present narcotic antagonists (such as naloxone and cyclazocine) have too brief an effect and too many side effects to be completely satisfactory. A new drug, naltrexone, appears to be more promising since its effects last longer, and it appears to be more acceptable to the treatment clients. Narcotic antagonists prevent or abolish excessive respiratory depression caused by the administration of morphine or related compounds. They are also used to treat asphyxia neonatorum and for the diagnosis of possible narcotic addiction.

SPECIFIC NARCOTIC ANTAGONISTS

NALOXONE. Naloxone is (5R, 9R, 13S, 14S)-N-allyl-4, 5-epoxy-3, 14-dihydroxymorphinan-6-one. Naloxone is a derivative of 7, 8-dihydro-14-hydroxymorphinone having an allyl group at the nitrogen. Naloxone is administered by IV or IM (low oral bioavailability and slow action) and has a relatively short half-life (1 hour).

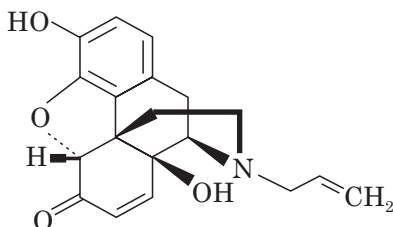

Characters. Naloxone is available as hydrochloride salt. Naloxone hydrochloride is a white or almost white, crystalline powder, hygroscopic, freely soluble in water, soluble in alcohol, practically insoluble in ether.

Preparations. Naloxone Injection, Neonatal Naloxone Injection.

Uses. Naloxone is a pure antagonist with no morphine like effects. It blocks the euphoric effect of heroin when given before heroin.

NALORPHINE. Nalorphine is N-allylmorphine. In morphine tertiary nitrogen is attached to an allyl ($-\text{CH}_2\text{CH}=\text{CH}_2$) group.

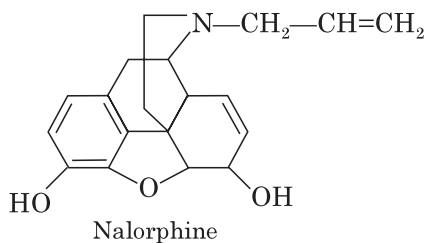

Nalorphine is synthesised from normorphine by allylation.

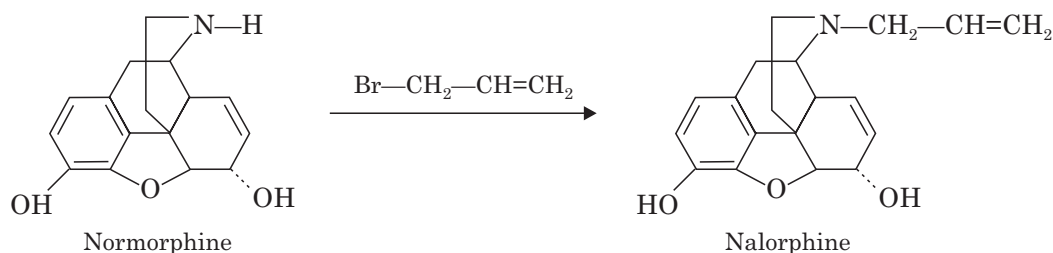

Nalorphine is available as hydrochloride salt. Nalorphine hydrochloride is white colored, odorless, crystalline powder. It darkens on exposure to light. It is soluble in water, dilute alkali hydroxide solution but insoluble in chloroform and ether. It must be kept in tightly closed light resistant containers.

Uses. Nalorphine is a narcotic antagonist used to treat narcotic-induced respiratory depression. It is administered by intravenous injection for treating the overdose of morphine, pethidine, methadone and levorphanol. Nalorphine precipitates withdrawal symptoms and produces behavioral disturbances in addition to the antagonism action.

LEVALLORPHAN. Levallorphan is available as tartarate salt. Levallorphan tartarate occurs as white colored, odorless, crystalline powder. It melts at 175°C and is slightly soluble in water but insoluble in ether and chloroform.

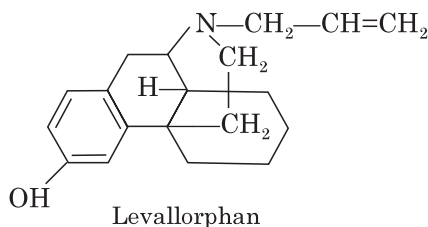

Levallorphan is synthesized from levorphanol by the following steps:

- (i) Levorphanol is demethylated by treatment with cyanogen bromide (to convert N-methyl group to N-cyano) followed by alkaline hydrolysis.

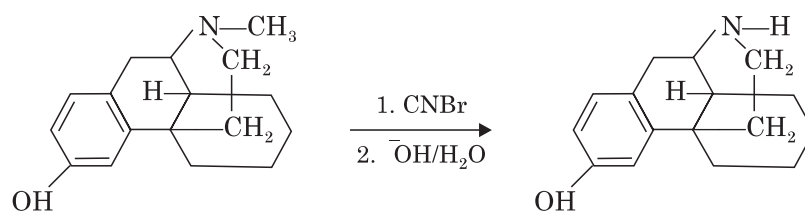

- (ii) Demethylated levorphanol is allylated with equimolar quantities of allyl bromide in presence of a base catalyst.

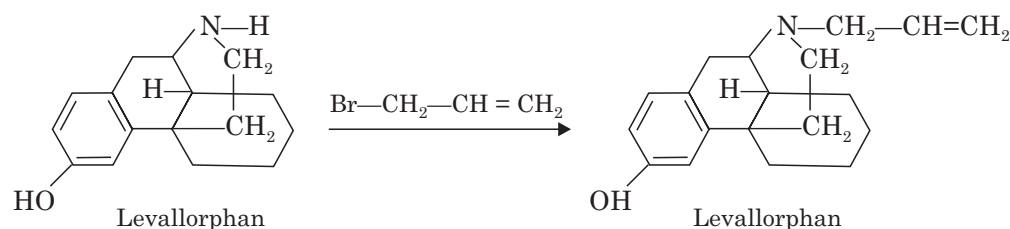

Uses. Levallorphan is a potent narcotic antagonist used in the treatment of narcotic-induced respiratory depression.

NALTREXONE. Naltrexone is structurally similar to naloxone except that a cyclopropyl methyl rather than an alkyl group is present at the piperidine nitrogen of oxymorphone moiety. It has long duration of action than naloxone, due to bulky cyclopropyl methyl group at N-atom, which sterically hinders its metabolism. Naltrexone became clinically available in 1985 as a new narcotic antagonist. Its actions resemble those of naloxone, but naltrexone is well absorbed orally and is long acting.

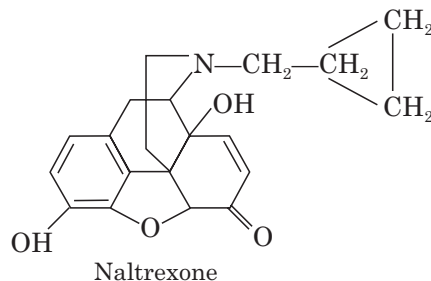

Naltrexone occurs as naltrexone hydrochloride salt. Naltrexone hydrochloride occurs as white crystals melting at 275°C. It is soluble in water.

Naltrexone is used orally and has a substantially longer half-life (10 hours) and duration (24-48 hours) of action. Naltrexone appears to be particularly effective for the treatment of narcotic dependence in addicts who have more to gain by being drug-free rather than drug dependant.

CYCLAZOCINE. Cyclazocine is a benzomorphan derivative. It has both opioid agonist activity at kappa receptors and antagonistic action. It reduces the intensity of euphoric, miosis, respiratory depression and physical dependence properties of opioid agonists. It is orally effective and has long duration of action.

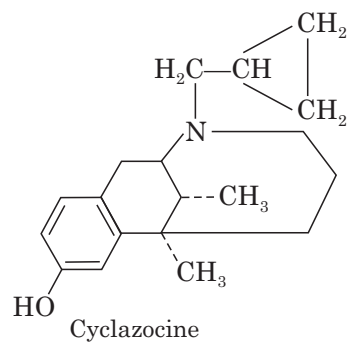

17

Antitussives

INTRODUCTION

Cough is a useful physiological mechanism to clear the respiratory passages of foreign material and excess secretions. The cough reflex is complex, involves the central nervous system, peripheral nervous system and smooth muscles of bronchial tree. Although cough is useful physiological function, it has to be controlled if it becomes too severe or too frequent or non-reproductive with pain and fatigue. In such cases, the physician should recommend the use of antitussives.

CLASSIFICATION OF ANTITUSSIVES

Antitussives are the drugs used for suppression of cough. The drugs used for the treatment of cough are classified are:

1. **Centrally acting antitussives.** These drugs reduce cough as a result of their central action. They depress the area of the CNS, which controls the cough reflex. They are mainly useful in the symptomatic relief of dry irritant type of cough.
 - (a) Opium alkaloids: Morphine, codeine
 - (b) Derivatives of opium alkaloids: Pholcodeine, Ethylmorphine, Noscapine
 - (c) Synthetic morphine substitutes: Dextromethorphan, Levopropoxyphene
 - (d) Non-opioid synthetics: Caramiphen, Dimethoxanate, Chlorphedianol.
2. **Pheripherally acting antitussives.** These agents act ppheripherally in the respiratory tract to reduce the impulses which stimulate the cough center. *Ex:* Benzonatate.

CODEINE

Codeine is an alkloid obtained from opium (0.7 to 2.5%) or prepared by methylating hydroxyl group of morphine with methyl iodide in potassium hydroxide. Chemically codeine is 7, 8-didehydro-4, 5-epoxy-3-methoxy-17-methylmorphinan-6-ol.

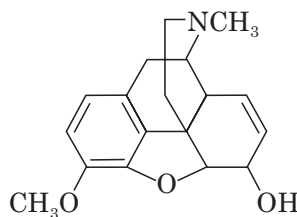

Codeine

Codeine occurs as odorless, colorless, crystalline powder. It is laevorotatory compound and is slightly soluble in water. It should be kept in a well closed light resistant container. It is also available as colorless, water soluble hydrochloride or phosphate salts.

Mechanism of action. Codeine acts by the inhibition of the CNS medulla mediated cough reflex.

Uses. Codeine has been used for pain relief and suppression of cough.

DEXTROMETHORPHAN

Dextromethorphan is a synthetically produced substance that is related to codeine. Chemically it is 3-methoxy-17-methyl-9 α , 13 α , 14 α -morphinan. It has central cough suppressant action but it does not feature the untoward effects of the opioids. Its metabolism is genetically polymorphous, similar to the codeine metabolism. According to more recent studies (performed predominantly on animals), the substance also has antiepileptic, neuroprotective, and antiparkinsonian properties.

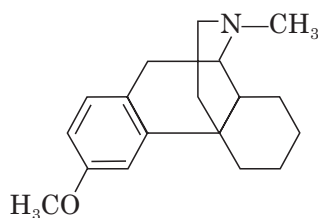

Dextromethorphan

Properties. It is white colored, odorless, solid-crystals or solid-powder. It is soluble in water 1.5 g/100 mL, soluble 1 in 10 of ethanol, freely soluble in chloroform and practically insoluble in ether. It should be preserved in air-tight and light-resistant containers.

Uses. It is used in cough/cold preparations as an antitussive (not with expectorant).

BENZONATATE

Benzonatate is structurally related to tetracaine. It is a non-opioid synthetic antitussive drug.

Mechanism of action. Benzonatate anesthetize the stretch receptors in the respiratory areas dampening their activity reducing cough reflex at its source.

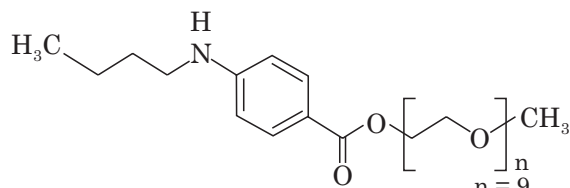

Benzonatate

NOSCAPINE

Noscapine is a phthaleideisoquinoline alkaloid ($C_{22}H_{23}NO_7$) from plants of the Papaver genus (Papaveraceae). Chemically it is (3S)-6, 7-dimethoxy-3 [(5R)-5, 6, 7, 8-tetrahydro-4-methoxy-6-methyl-1, 3-dioxolo [4, 5-g] isoquinolin-5-yl] phthalide monohydrochloride hydrate.

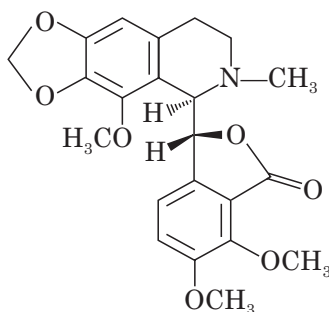

Biological Activity. Noscapine is an antitussive agent, acting on central nervous system site. It also possess weak bronchodialator properties. However, unlike codeine and other narcotics, noscapine lacks addictive, analgesic, respiratory depressant, and sedative properties. High affinity noscapine binding sites are brain specific and ion insensitive.

CARAMIPHEN

Caramiphen is a non-opioid synthetic antitussive agent. Caramiphen is less active than codeine but has longer duration of action. Caramiphen is synthesized from phenylacetone nitrile as:

- (i) Phenylacetone nitrile on double alkylation with 1, 4-dibromobutane gives substituted cyclopentane derivative which on hydrolysis with alkali followed by treatment with thionyl chloride provides acid chloride derivative.

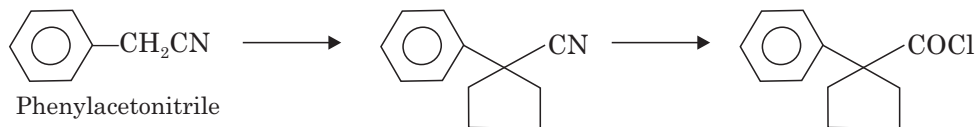

- (ii) Condensation of acid chloride derivative with diethylaminoethanol gives caramiphen.

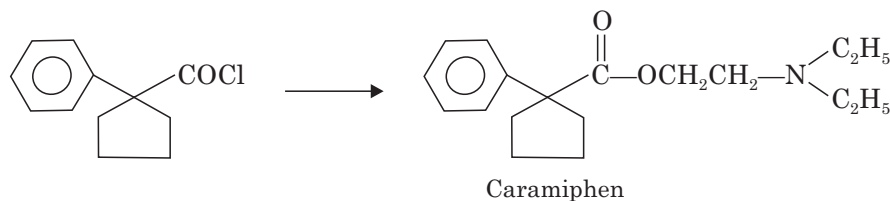

18

Non-Steroidal Antiinflammatory Drugs (NSAIDs)

INTRODUCTION

The non-steroidal antiinflammatory drugs (NSAIDs) are widely used for the treatment of minor pain and for the management of edema and tissue damage resulting from inflammatory joint disease (arthritis). A number of these drugs possess antipyretic activity in addition to having analgesic and antiinflammatory actions, and thus have utility in the treatment of fever. Some of the primary indications for NSAID therapy include: Rheumatoid arthritis, osteoarthritis (OA), acute gouty arthritis, ankylosing spondylitis, dysmenorrhea and tissue damage resulting from inflammatory joint disease (arthritis).

ROLE OF CYCLOOXYGENASE (COX) ISOENZYMES IN INFLAMMATION

Two COX isoenzymes have been identified: COX-1 and COX-2. COX-1 constitutive enzyme is present in a wide variety of cell types and influences the “housekeeping” functions of prostaglandins. This activity is particularly important in the gastrointestinal (GI) tract, the kidneys, and the circulatory system. COX-2, on the other hand, is inducible enzyme, is found in only a few cell types, especially macrophages and other leukocytes, fibroblasts, and endothelial cells, including those of the vascular system. COX-2 is involved in those aspects of the inflammatory process that are mediated by prostaglandins (in Figure).

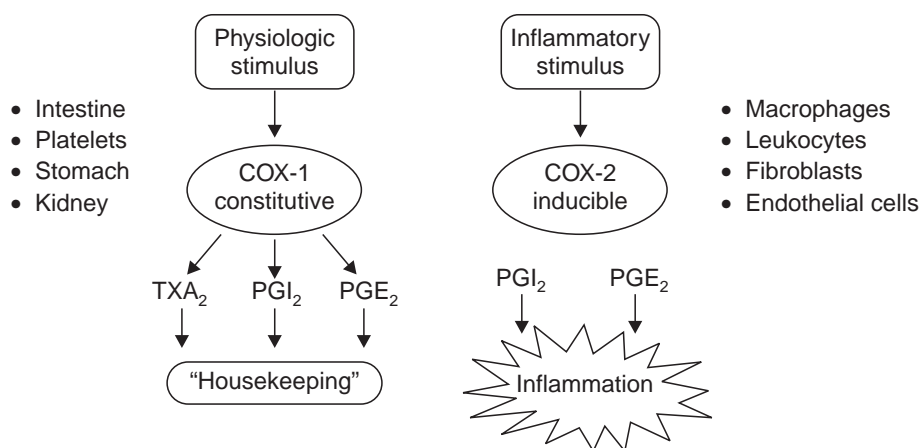

Differing roles of COX-1 and COX-2 enzymes.

NSAIDs MECHANISM OF ACTION

1. The major mechanism by which the NSAIDs elicit their therapeutic effects (antipyretic, analgesic, and antiinflammatory activities) is inhibition of prostaglandin (PG) synthesis. Specifically NSAIDs competitively (for the most part) inhibit cyclooxygenases (Prostaglandin synthetase), the enzymes that catalyze the synthesis of cyclic endoperoxides from arachidonic acid to form prostaglandins.
2. Generally, the NSAIDs inhibit both COX-1 and COX-2. Most NSAIDs are mainly COX-1 selective (*e.g.*, aspirin, ketoprofen, indomethacin, piroxicam, sulindac). Others are considered slightly selective for COX-1 (*e.g.*, ibuprofen, naproxen, diclofenac) and others may be considered slightly selective for COX-2 (*e.g.*, etodolac, nabumetone, and meloxicam). The mechanism of action of celecoxib and rofecoxib is primarily selective inhibition of COX-2; at therapeutic concentrations, the COX-1 isoenzyme is not inhibited thus GI toxicity may be decreased.
3. Other mechanisms that may contribute to NSAID antiinflammatory activity include the reduction of superoxide radicals, induction of apoptosis, inhibition of adhesion molecule expression, decrease of nitric oxide synthase, decrease of proinflammatory cytokine levels (tumornecrosis factor- α , interleukin-1), modification of lymphocyte activity, and alteration of cellular membrane functions.

Antipyretic activity of NSAIDs results from inhibition of prostaglandin E₂ (PGE₂) synthesis in circumventricular organs in and near the preoptic hypothalamic area. Infections, tissue damage, inflammation, graft rejection, malignancies, and other disease states enhance the formation of cytokines that increase PGE₂ production. PGE₂ triggers the hypothalamus to promote increase in heat generation and decreases in heat loss.

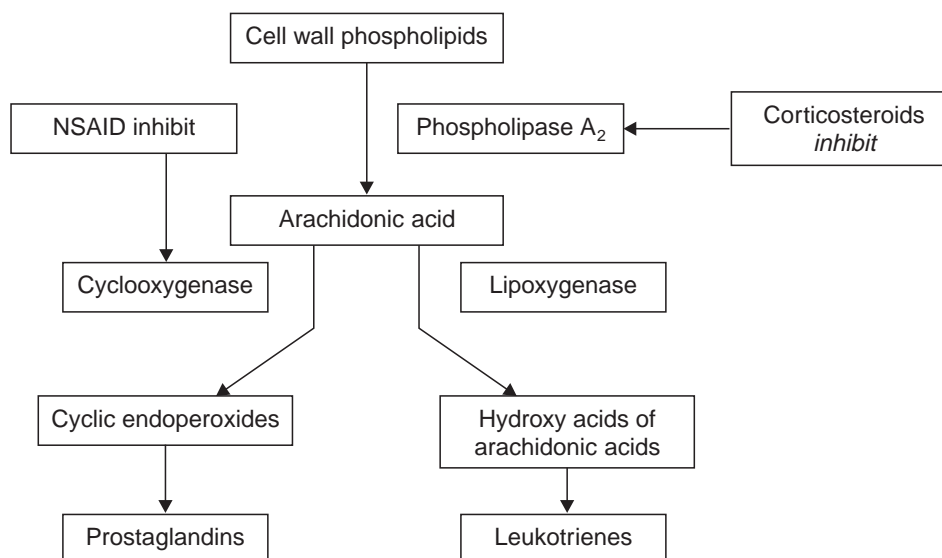

Biosynthetic pathways of prostaglandins and the mechanism of drugs which inhibit their production.

CLASSIFICATION OF NSAIDs

The NSAIDs can be sub-classified on the basis of chemical structure as follows:

- | | |
|------------------------------------|------------------------------|
| 1. Salicylates | 2. Propionic acids (Profens) |
| 3. Aryl and heteroarylacetic acids | 4. Anthranilates (Fenamates) |
| 5. Oxicams (“Enol Acids”) | 6. Phenylpyrazolones |
| 7. Anilides. | |

GENERAL STRUCTURE AND PROPERTIES OF NSAIDs

In general, NSAIDs structurally consist of an acidic moiety (carboxylic acid, enols) attached to a planar, aromatic functionality. Some analgesics also contain a polar linking group, which attaches the planar moiety to an additional lipophilic group. This can be represented as follows:

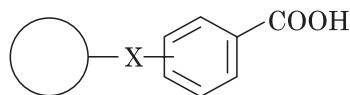

NSAIDs general structure

1. The NSAIDs are characterized by the following chemical/ pharmacologic properties:
2. All are relatively strong organic acids with pKa in the 3.0–5.0 range. Most, but not all, are carboxylic acids. Thus, salt forms can be generated upon treatment with base and all of these compounds are extensively ionized at physiologic pH. The acidic group is essential for COX inhibitory activity.
3. The NSAIDs differ in their lipophilicities based on the lipophilic character of their aryl groups and additional lipophilic moieties and substituents.
4. The acidic group in these compounds serves a major binding group (ionic binding) with plasma proteins. Thus all NSAIDs are highly bound by plasma proteins (drug interactions).
5. The acidic group also serves as a major site of metabolism by conjugation. Thus a major pathway of clearance for many NSAIDs is glucuronidation (and inactivation) followed by renal elimination.

I. Salicylates

Structure and chemistry. The salicylates are derivatives of 2-hydroxybenzoic acid (salicylic acid). They were discovered in 1838 following the extraction of salicylic acid from willow bark. Salicylic acid was used medicinally as the sodium salt but replaced therapeutically in the late 1800s by acetylsalicylic acid (aspirin).

Mechanism of Action. The salicylates have potent antiinflammatory activity with mild analgesic and antipyretic activities. These compounds are mainly COX-1 selective—they are bound with higher affinity to COX-1. The therapeutic and some of the toxic actions (*i.e.* gut) of aspirin can be related to its ability to inhibit COX-1 in various tissues and participate in transacetylation reactions *in vitro*.

Sodium Salicylate. Sodium salicylate is sodium 2-hydroxybenzenecarboxylate. It occurs as a white, crystalline powder or small, colorless crystals or shiny flakes, freely soluble in water, sparingly soluble in alcohol and practically insoluble in ether. It should be stored in an airtight container, protected from light. Sodium salicylate is employed for the relief of pain, rheumatic fever and symptomatic treatment of gout.

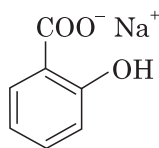

Magnesium salicylate. Magnesium salicylate is prepared by mixing of salicylic acid with sufficient quantity of magnesium oxide in isopropanol and water mixture.

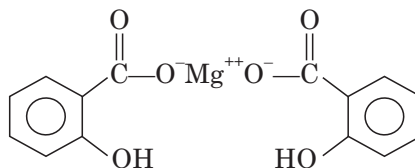

Magnesium salicylate is white to slightly pink color crystalline powder. It reduces inflammation and pain by blocking production and release of chemicals that produce it. It controls fever by regulating the body's thermostat in the brain.

Salicylamide. Salicylamide is *o*-hydroxybenzamide. It is prepared by adding solution of ammonia to salicyl chloride.

Salicylamide is available as white crystalline, odorless powder. It is slightly soluble in water, and freely soluble in alkalis. Salicylamide is decomposed in alkaline solutions. Salicylamide exert moderately quicker and deeper analgesic effect than aspirin.

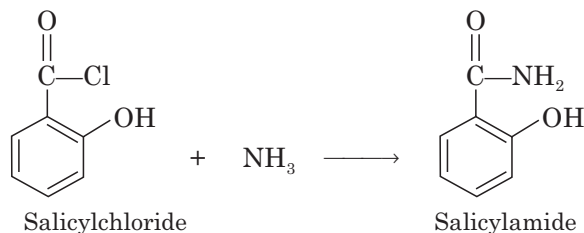

Phenyl salicylate(Salol). Phenyl salicylate is prepared by esterification of salicylic acid with phenol.

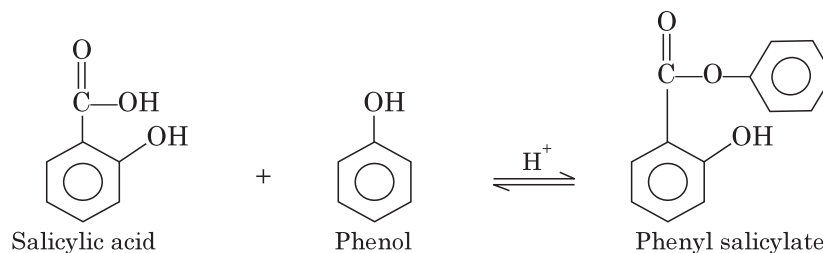

Phenyl salicylate is available as white crystalline powder with aromatic odor. It is insoluble in water but freely soluble in alcohol, ether, chloroform, acetone and fixed oils.

Uses. Phenyl salicylate is used for the treatment of sunburns.

Aspirin. Acetylsalicylic acid is an acetyl derivative of salicylic acid. It was introduced into medicine by Dreser in 1899. Acetyl salicylic acid (aspirin) can be prepared by the reaction between salicylic acid and acetic anhydride.

In this reaction, the hydroxyl group on the benzene ring in salicylic acid reacts with acetic anhydride to form an ester functional group. Thus, the formation of acetyl salicylic acid is referred to as an esterification reaction. This reaction requires the presence of an acid catalyst.

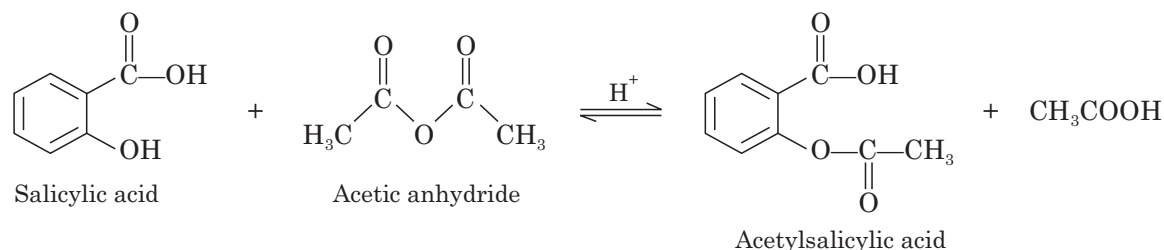

Properties. Aspirin occurs as colorless crystals or powder. It is slightly soluble in water and soluble in alcohol, chloroform, ether and glycerin.

Aspirin is stable in dry air but in presence of moisture, it hydrolyses slowly into salicylic acid and acetic acid. Aspirin is acidic and produces effervescence with carbonates and bicarbonates.

Use. Aspirin is used as an antipyretic, analgesic and antirheumatic.

Aluminium Aspirin. Aluminium aspirin is aluminium salt of aspirin. It is prepared by mixing of aluminium hydroxide gel with water and acetylsalicylic acid at 65°C.

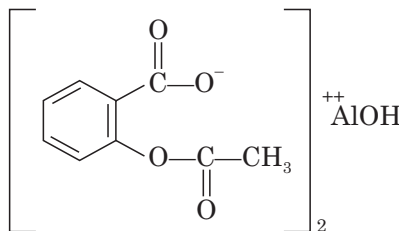

Aluminium aspirin is available as white color, odorless powder or granules. It is insoluble in water and organic solvents. Aluminium aspirin is unstable above 65°C and is decomposed by bases (alkali hydroxides and carbonates).

Calcium Acetylsalicylate. Calcium aspirin is a calcium salt of acetylsalicylic acid. It is prepared by mixing acetylsalicylic acid with calcium ethoxide or methoxide in alcohol or acetone solution.

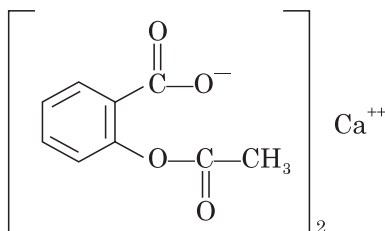

Calcium aspirin is readily soluble in water but sparingly soluble in alcohol.

Flufenisol. Chemically flufenisol is acetyl-5-(4-fluorophenyl) salicylic acid. Flufenisol is more potent, long acting NSAID and produces less gastric irritation.

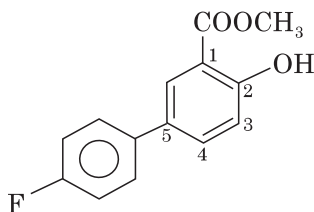

Propionic Acid Derivatives (Profens)

Structure and chemistry. Some of the most useful NSAIDs are structurally derived from arylacetic acids. These compounds are often referred to as the “profens” based on the suffix of the prototype member, ibuprofen. Like the salicylates these agents are all strong organic acids ($pK_a = 3.0-5.0$) and thus form water soluble salts with alkaline reagents. The arylpropionic acids are characterized by the general structure $Ar-CH(CH_3)-COOH$ which conforms to the required general structure. All of these compounds are predominantly ionized at physiologic pH and more lipophilic than acetyl salicylic acid or salicylic acid. The $\alpha-CH_3$ substituent present in the profens increases cyclooxygenase inhibitory activity and reduces toxicity of the profens. The α -carbon in these compounds is chiral and the S-(+)-enantiomer of the profens is the more potent cyclooxygenase inhibitor.

Mechanism of Action. The members of this series are:

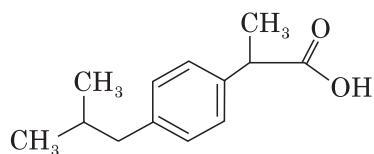

Ibuprofen

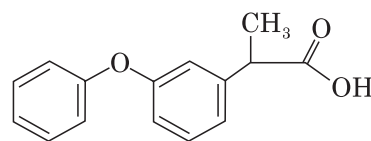

Fenoprofen

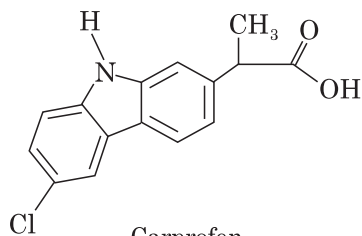

Carprofen

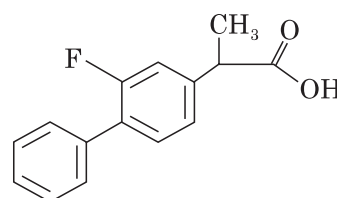

Flurbiprofen

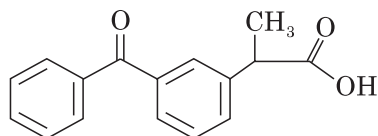

Ketoprofen

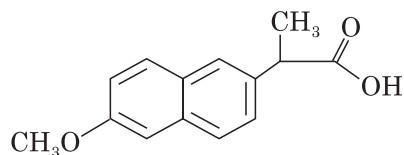

Naproxen

Generally the profens are considered to be slightly “COX-1 selective”; naproxen appears to be more selective for COX-2 than other members of this series. They are used for rheumatoid arthritis, osteoarthritis and as analgesics and antipyretics. They should not be used during pregnancy or nursing; they can enter fetal circulation and breast milk. They produce less GI ulceration than the salicylates.

Synthesis of Ibuprofen. There have been many commercial and laboratory publications for the synthesis of ibuprofen. Two of the most popular ways to obtain ibuprofen are the Boot process and the Hoechst process. The Boot process is an older commercial process developed by the Boot Pure Drug Company, and the Hoechst process is a newer process developed by the Hoechst Company. Most of these routes to ibuprofen begin with isobutylbenzene and use Friedel-Craft’s acylation. The Boot process requires six steps, while the Hoechst process, with the assistance of catalysts, is completed in only three steps.

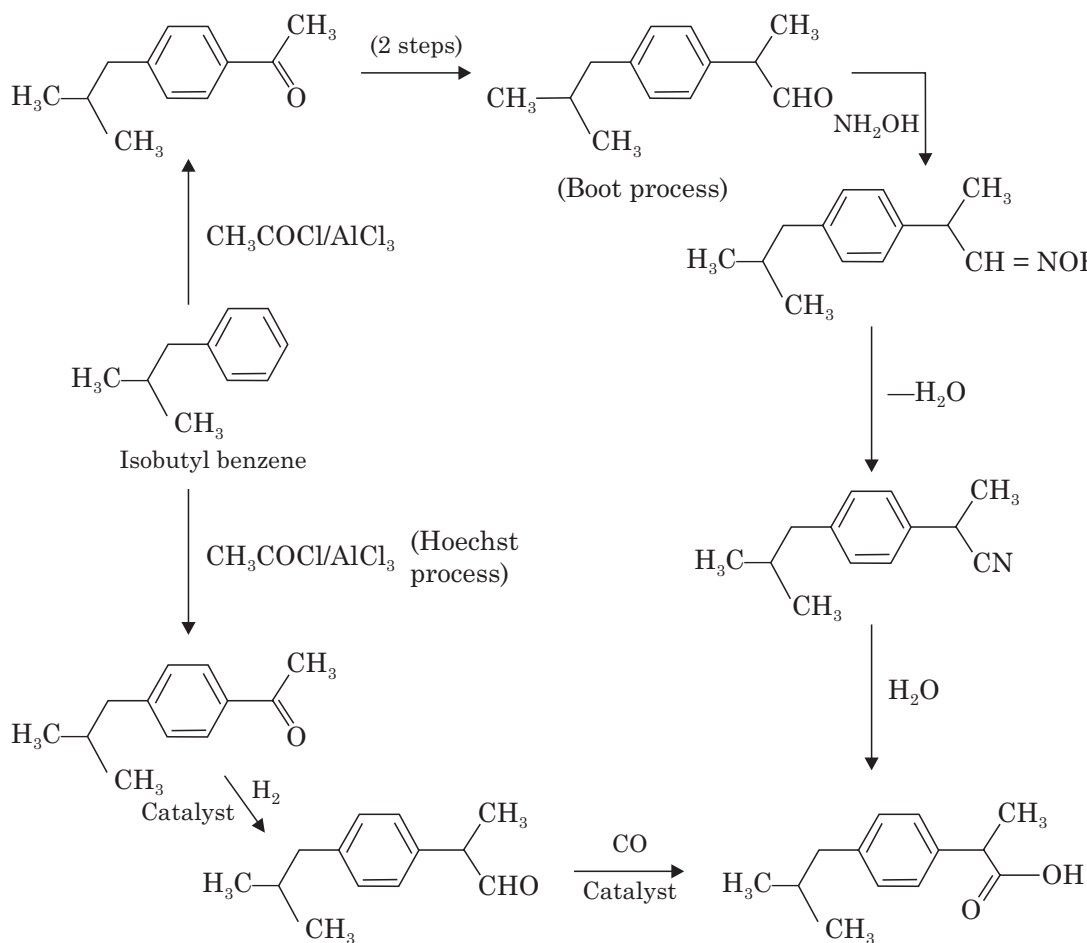

Naproxen. Naproxen is a naphthyl 6-methoxyispropionic acid. Naproxen is nonsteroidal antiinflammatory, antirheumatic, analgesic, antidysmenorrhoeal and vascular headache suppressant.

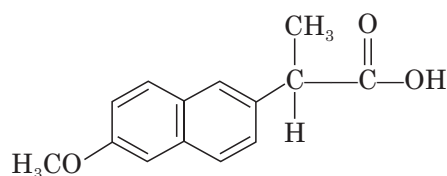

Mechanism of actions. The effectiveness of naproxen is due partly to its ability to inhibit cyclooxygenase 1 and 2. Naproxen as such irreversibly blocks the enzyme cyclooxygenase (prostaglandin synthase), which catalyzes the conversion of arachidonic acid to endoperoxide compounds; at appropriate doses, the drug decreases the formation of the prostaglandins.

Synthesis of Naproxen. Naproxen can be prepared by following reactions ;

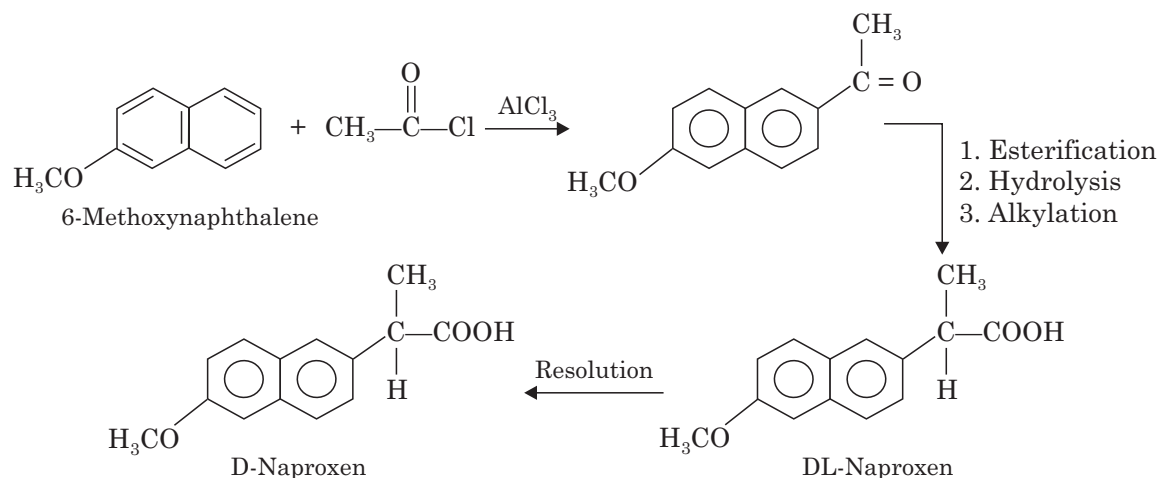

Aryl and heteroarylacetic acids

General structure and chemistry. These compounds are also derivatives of acetic acid, but in this case the substituent at the 2-position is a heterocycle or related carbo cycle. This does not significantly effect the acidic properties of these compounds. The heteroarylacetic acid NSAIDs can be further subclassified as the indene/indoles, the pyrroles and the oxazoles as shown below:

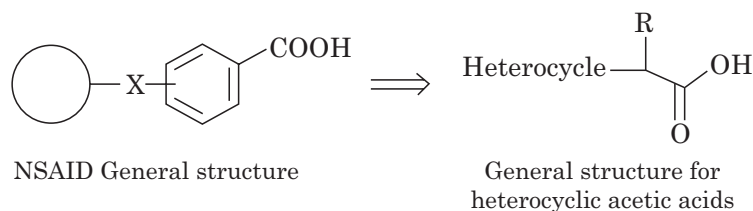

A. Indene and Indole Acetic Acids

Structure-activity relationships :

1. The carboxyl group is essential for antiinflammatory activity.
2. Presence of methoxy (position 5) group on the ring (5 or 6), methyl (2), dimethyl amino group (5) in indole moiety of indomethacin exhibit activity.
3. Presence of chlorine or fluorine or CF_3 groups at para position of phenyl group also exhibits anti-ionflammatory activity.

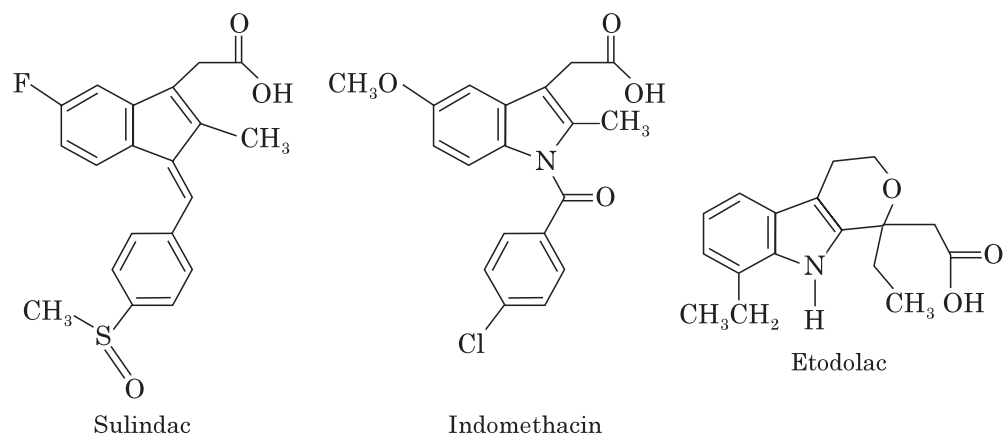

Indomethacin. Indomethacin contains a benzoylated indole nitrogen. Indomethacin was introduced in 1964 as a powerful anti-inflammatory, analgesic agent. Chemically, indomethacin is 1-(*p*-chlorobenzoyl)-5-methoxy-2-methylindole-3-acetic acid. Indomethacin is "COX-1" selective and produces primarily antiinflammatory actions with some analgesic and antipyretic activity. It is used for rheumatoid arthritis, osteo arthritis, ankylosing spondylitis, to suppress uterine contraction, and to promote closure of parent ductus artiosus in neonates (premature infants).

It is synthesized from 4-methoxyphenylhydrazine by following method:

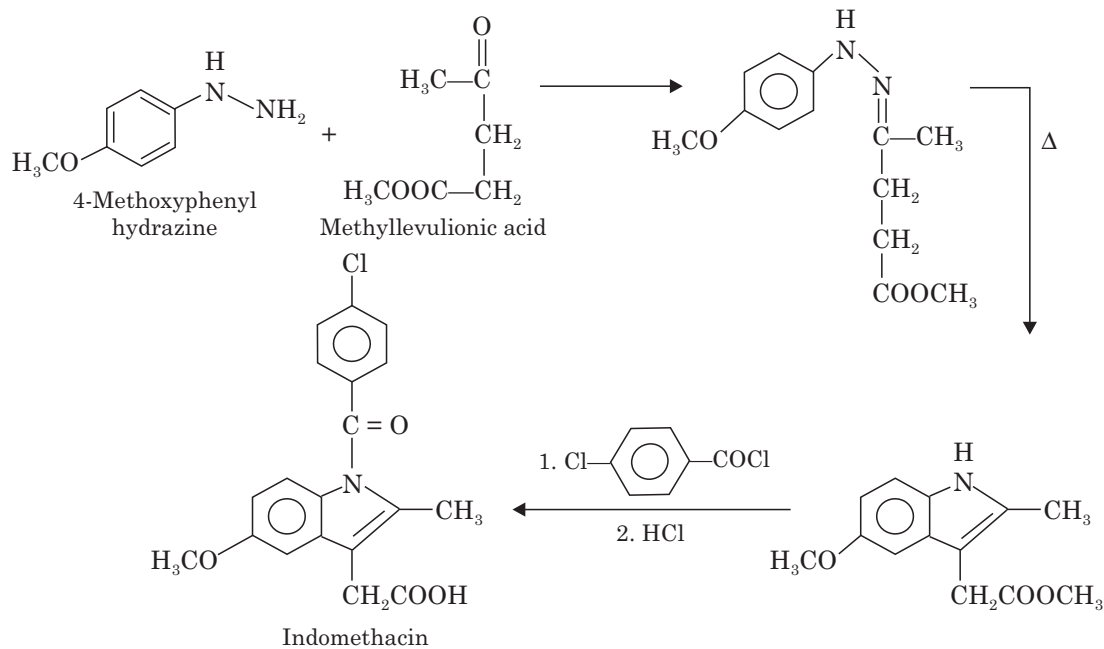

Indomethacin is available as white to yellow crystalline powder. It is practically soluble in water. The most frequent side effects are peptic ulcer, blood disorders and gastrointestinal disturbances.

Sulindac. In this agent the indole nitrogen has been eliminated which makes the drug resemble to 5-HT and therefore fewer CNS side effects are seen. This compound has pharmacological actions similar to indomethacin (COX-1 selective and antiinflammatory primarily). It is used for rheumatoid arthritis, osteoarthritis, ankylosing spondylitis, acute gout and to inhibit uterine contractions.

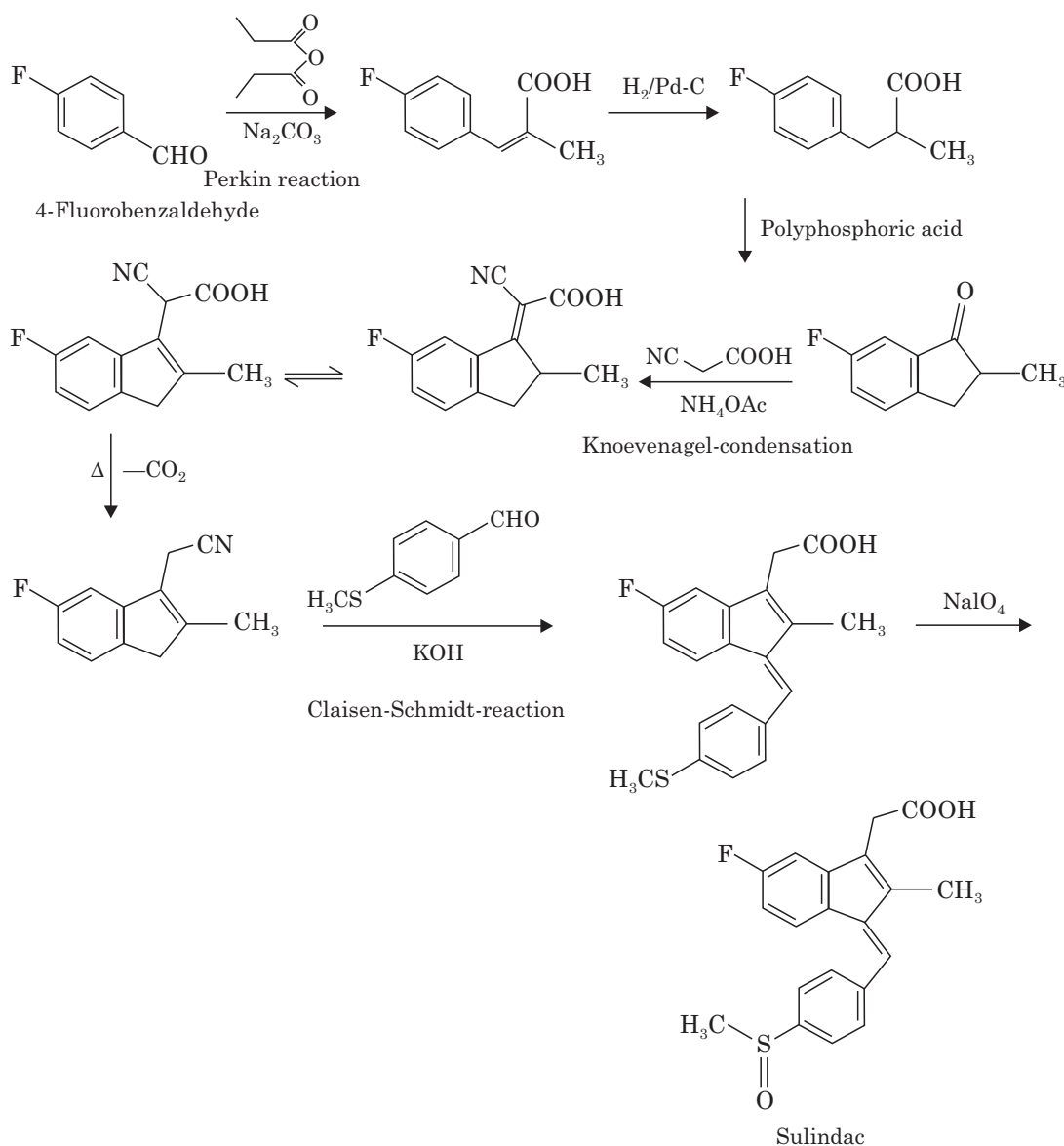

Industrial synthesis of Sulindac.

B. Arylacetic acids. The pyrrole acetic acids :

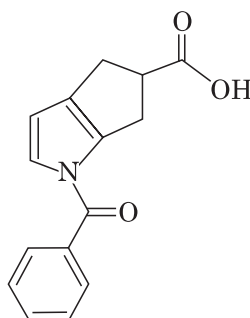

Ketorolac

Ketorolac which lacks benzylic methyl group is not susceptible to oxidation and as a result its half-life is longer (4-6 hours). This drug is unique in that it is formulated for oral and IM administration. Good oral activity with primarily analgesic activity, but also has anti-inflammatory activity and antipyretic actions. Used in the management of post-operative pain

C. Arylacetic acids: Oxazole acetic acids. A recent addition (1993) to this class of agents is oxaprozin another non-selective COX inhibitor. It differs slightly in that substitution of the propionic moiety is at the 3-position rather than at the 2-position as in other agents of this class.

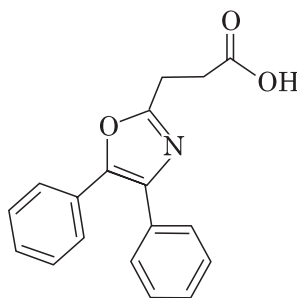

Oxaprozin

ANTHRANILATES (FENAMATES)

Structure and chemistry. Anthranilates are considered to be N-aryl substituted derivatives of anthranilic acid, which is a bioisostere of salicylic acid. These agents retain the acidic properties that are characteristic of this class of agents. The most active fenamates have small alkyl or halogen substituents at the 2', 3' and/or 6' position of the N-aryl moiety (meclofenamate is 25 times more potent than mefenamate). Among the disubstituted N-aryl fenamates the 2', 3'-derivatives are most active suggesting that the substituents at the 2', 3'-positions serve to force the N-aryl ring out of coplanarity with the anthranilic acid. Hence this steric effect is proposed to be important in the effective interaction of the fenamates at their inhibitory site on cyclooxygenase.

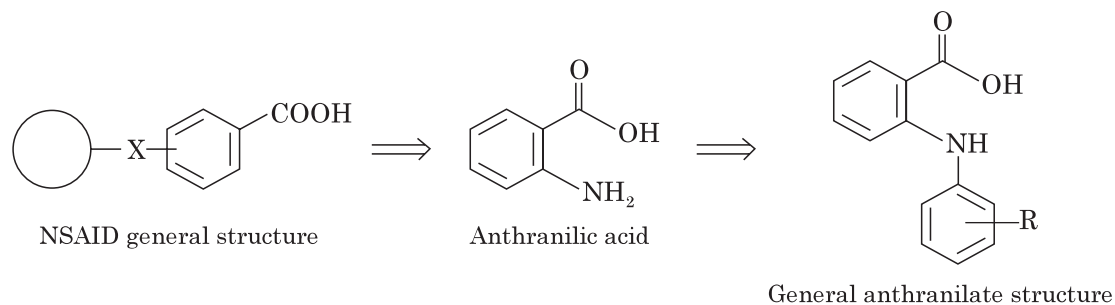

Actions. The anthranilates have primarily antiinflammatory with some analgesic and antipyretic activity and are non-COX selective. The anthranilates are used as mild analgesics and occasionally to treat inflammatory disorders. Diclofenac is used for rheumatoid arthritis, osteoarthritis and post-operative pain and mefenamic acid as an analgesic for dysmenorrhea. The utility of this class of agents is limited by a number of adverse reactions including nausea vomiting, diarrhoea, ulceration, headache, drowsiness and hematopoietic toxicity.

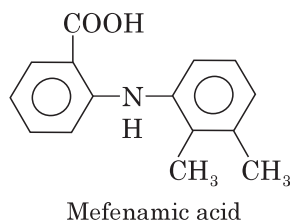

Synthesis of mefenamic acid. Mefenamic acid can be prepared by following reactions :

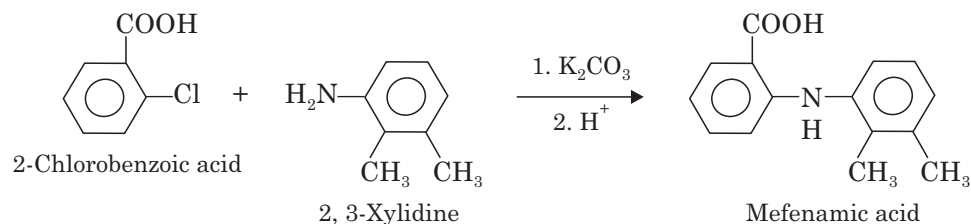

Meclofenamic acid is used in the treatment of acute and chronic rheumatoid arthritis.

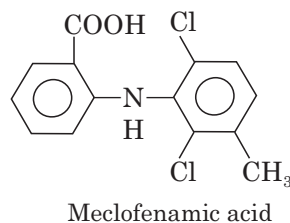

OXICAMS (ENOLIC ACIDS)

Structure and chemistry. Oxicams (Piroxicam and Meloxicam) are characterized by the 4-hydroxybenzothiazine heterocycle. The acidity of the oxicams is attributed to the 4-OH with the enolate anion being stabilized by intramolecular hydrogen-bonding to the amide N-H group. These compounds are acidic ($pK_a = 6.3$). The oxicams are primarily ionized at physiologic pH and acidity is required for COX inhibitory activity.

Actions. Higher COX-2 selectivity than many other NSAIDs, particularly meloxicam. These agents have utility in treatment of rheumatoid arthritis and osteoarthritis

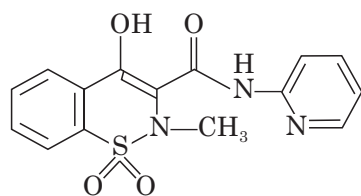

Piroxicam

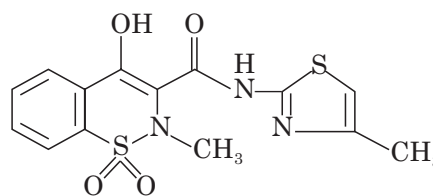

Meloxicam

Synthesis of piroxicam. Piroxicam can be synthesized by the following chemical reactions :

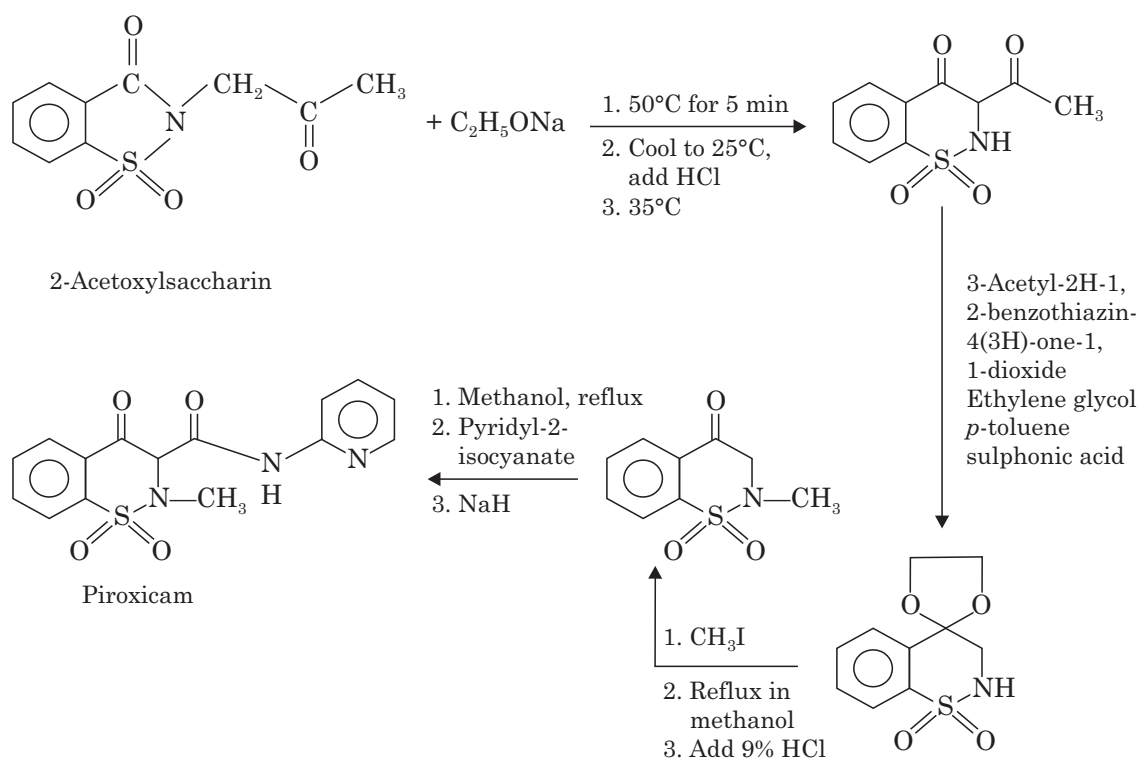

PHENYLPYRAZOLONES

Structure and chemistry. This class of agents are characterized by the 1-aryl-3,5-pyrazolidinedione structure. The presence of a proton which is situated α to two electron with-

drawing carbonyl groups renders these compounds acidic. The pKa for phenylbutazone is 4.5. Oxyphenbutazone is a hydroxylated metabolite of phenylbutazone.

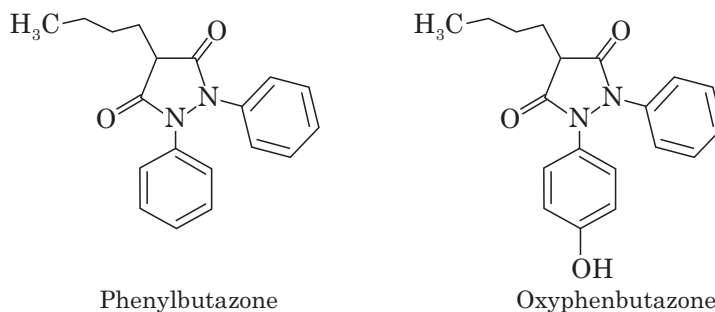

Actions. These drugs are primarily antiinflammatory, but has some analgesic and anti-pyretic activities. They also has mild uricosuric activity. Phenylbutazone and oxyphenbutazone are used primarily in the treatment of rheumatoid arthritis and osteoarthritis. The most common adverse reactions include GI irritation, Na⁺ and H₂O retention and blood discarasis. Therapy should be limited to 7-10 days due to development of bone marrow depression.

Synthesis of phenyl butazone. Phenyl butazone can be prepared from butylmalonoyl ester by following reactions :

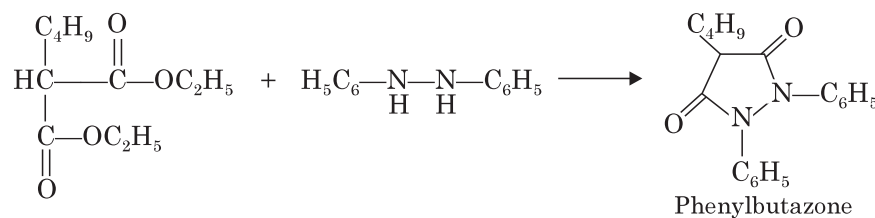

Synthesis of oxyphenbutazone. Oxyphenbutazone can be prepared from diethyl-butylmalonate by following reactions :

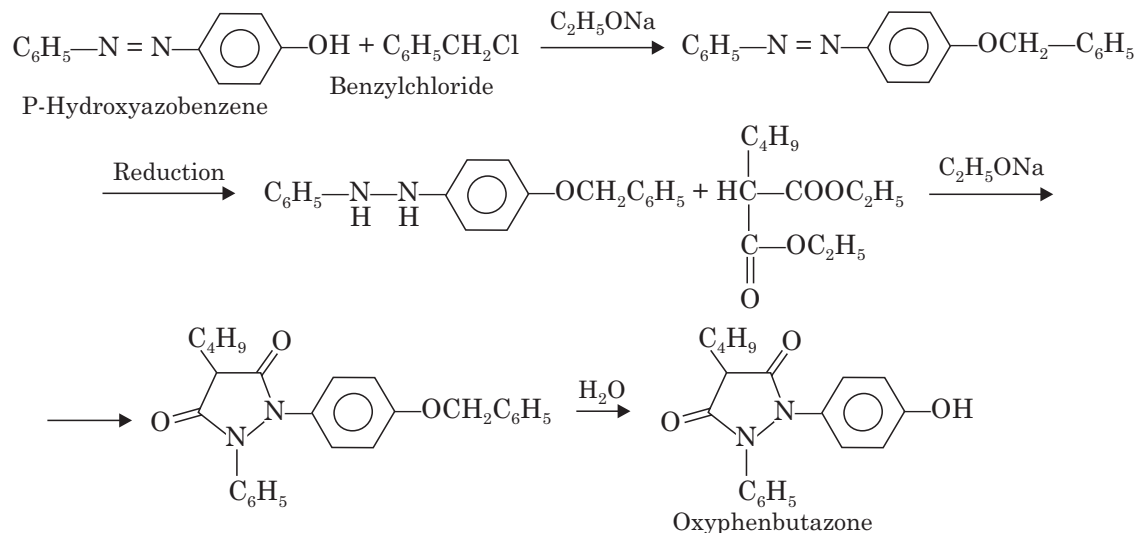

Antipyrine. Antipyrine is 2, 3-dimethyl-1-phenyl-3-pyrazolin-5-one. It was one of the first synthetic compounds to be used in medicine.

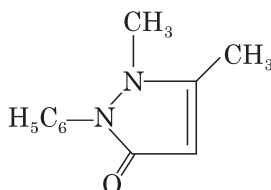

Antipyrine is available as colorless, crystalline powder or white powder. It is odorless and having slightly bitter taste. It is freely soluble in water, alcohol, and chloroform. Antipyrine has analgesic, antiinflammatory and antipyretic activities.

Aminopyrine. Aminopyrine is 2, 3-dimethyl-4-dimethylamino-1-phenyl-3-pyrazolin-5-one. Aminopyrin is available as colorless, odorless crystals. It is soluble in water and organic solvents.

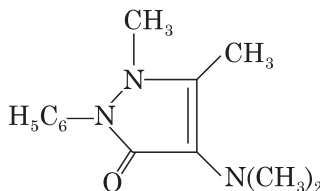

Use. Aminopyrin is used as an analgesic and antipyretic.

Dipyron. Dipyron occurs as a white, odorless crystalline powder. It has slightly bitter taste. It is freely soluble in water and sparingly soluble in alcohol.

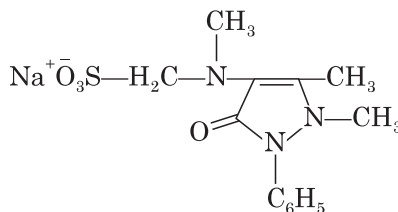

Uses. Dipyron is used as an analgesic, antipyretic and antirheumatic.

ANILIDES

Structure and chemistry. The anilides are simple acetamides of aniline, which may or may not contain a 4-hydroxy or 4-alkoxy group. Anilides do not possess the carboxylic acid functionality and therefore they are classified as neutral drugs and possess little inhibitory activity against cyclooxygenase.

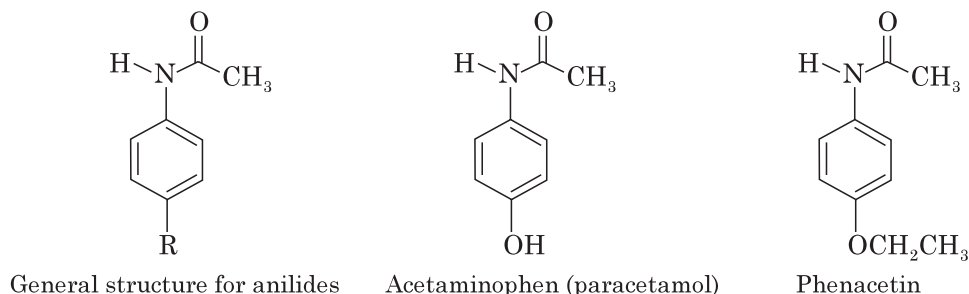

Actions. The anilides are somewhat different from other NSAIDs in their mechanism of action. They are believed to act as scavengers of hydroperoxide radicals (Hydroperoxide radicals are generated by invading leukocytes after injury has occurred. The hydroperoxide radicals have a stimulating effect on cyclooxygenase). In areas of high leukocyte activity (significant injury and inflammation) the high concentration of hydroperoxides are able to overcome the anilides and prostaglandins are produced. Therefore the anilides have no antiinflammatory action. They are only capable of suppressing cyclooxygenase activity in areas which are not inflamed. The lack of an acidic functionality and COX inhibitory activity in the anilides imparts several advantages to these agents including limited gastric irritation, ulceration, and respiratory effects and little effect on platelets (no increase in clotting).

Preparation of paracetamol involves treating an amine (p-aminophenol) with an acid anhydride (acetic anhydride) to form an amide (p-acetamidophenol).

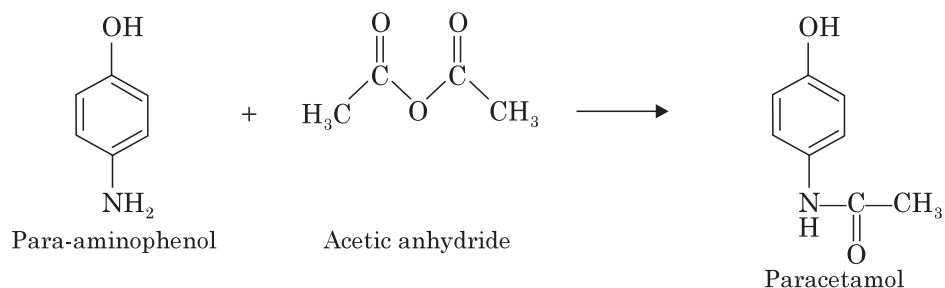

SELECTIVE COX-2 INHIBITORS

COX enzyme exists in 2 isoforms, COX-1 and COX-2. COX-1 enzyme is thought to mediate “housekeeping” or homeostatic functions, and COX-2 is considered an inducible enzyme in response to injury or inflammation. COX-2 inhibitors are the “new-generation” NSAIDs that may selectively block the COX-2 isoenzyme without affecting COX-1 function. This may result in control of pain and inflammation with a lower rate of adverse effects compared with older nonselective NSAIDs. Rapidly evolving evidence suggests that COX-2 enzyme has a diverse physiologic and pathologic role.

Structure and chemistry. The commercially available COX-2 inhibitors can be structurally characterized as diaryl-5-membered heterocycles.

Celecoxib has a central pyrazole ring and two adjacent phenyl substituents, one containing a methyl group and the other a polar sulfonamide moiety; the sulfonamide binds to a distinct hydrophilic region that is present on COX-2 but not COX-1.

Rofecoxib has a central furanose ring and two adjacent phenyl substituents, one containing a methyl sulfone group, unlike celecoxib. Rofecoxib is a powerful non-steroidal analgesic and antiinflammatory agent. The mechanism of action of rofecoxib is believed to be due to inhibition of prostaglandin synthesis, via inhibition of cyclooxygenase-2.

Valdecoxib is an aryl sulfonamide derivative like celecoxib. Valdecoxib is nonsteroidal anti-inflammatory drug that exhibits anti-inflammatory, analgesic and antipyretic properties. It acts by inhibiting prostaglandin synthesis primarily by blocking cyclooxygenase-2. At therapeutic plasma concentrations valdecoxib does not inhibit cyclooxygenase-1 (COX-1).

The efficacy and clinical utility of valdecoxib has been demonstrated in osteoarthritis, adult rheumatoid arthritis, in the treatment of primary dysmenorrhea and in the management of post operative pain.

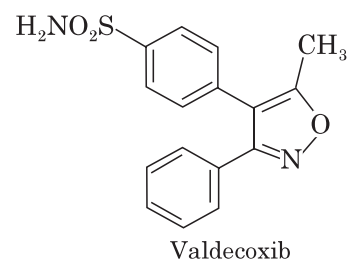
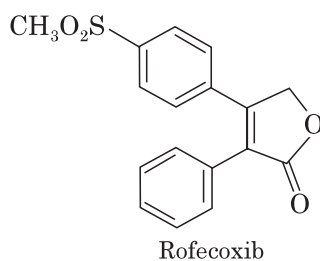
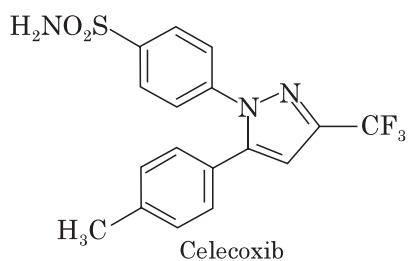

19 Local Anesthetics

INTRODUCTION

Local anesthetics are the drugs, which produce insensitivity in a limited area by blocking the generation and conduction of nerve impulses. They interrupt pain impulses in a specific region of the body without loss of patient consciousness. They are applied locally or injected to produce loss of sensation in the required area. Local anesthetics decrease the permeability of cell membrane to sodium thus prevents depolarisation. Normally, the process is completely reversible and the agent does not produce any residual effect on the nerve fibre.

CHEMISTRY OF LOCAL ANESTHETICS

All local anesthetic drugs except cocaine are synthetic. Traditionally there have been two main groups available for use, the Esters and the Amides. Both types of anesthetics have three main structural parts as follows:

1. Aromatic ring—the lipophilic portion.
2. Intermediate Chain—provides the link/spatial separation between the aromatic ring (lipophilic) and the amino group (hydrophilic). Local anesthetics are classified on the basis of the intermediate chain.
3. Secondary or tertiary amino terminus (amino group)—the hydrophilic portion. Generally local anesthetics are secondary or tertiary amines. The nitrogen is linked through an intermediary chain to a lipophilic portion (most often aromatic ring system).
4. The amine functional group of local anesthetics exists either as the neutral amine or positively charged ammonium cation, depending up on their dissociation constant (pK_a value) and the actual pH value.
5. The protonated local anesthetic possesses both a polar hydrophilic moiety (protonated nitrogen) and a non-polar lipophilic moiety (ring system).
6. The pK_a of typical local anesthetics lies between 7.7—9.3.
7. Chemically used local anesthetics are either esters or amides. The structural element is unimportant for efficacy. Even drugs containing a methylene bridge such as chlorpromazine or imipramine would exert a local anesthetic effect.

A. Ester Anesthetics

Ester anesthetics are metabolized in the plasma by the enzyme pseudocholinesterase. Procaine undergoes hydrolysis to para-aminobenzoic acid (PABA), which is excreted unchanged in the urine, and diethylamino alcohol, which undergoes further transformation prior to excretion. Allergic reactions that occur in response to ester anesthetics are usually not in response to the parent compound but rather to the para aminobenzoic acid (PABA), which is a major metabolic product of all ester-type local anesthetics.

Approximately 1 in 3000 persons has an atypical form of pseudocholinesterase, resulting in the inability to hydrolyze the ester-type local anesthetics. This in turn may cause a prolongation of high blood levels of the agent and increased toxicity.

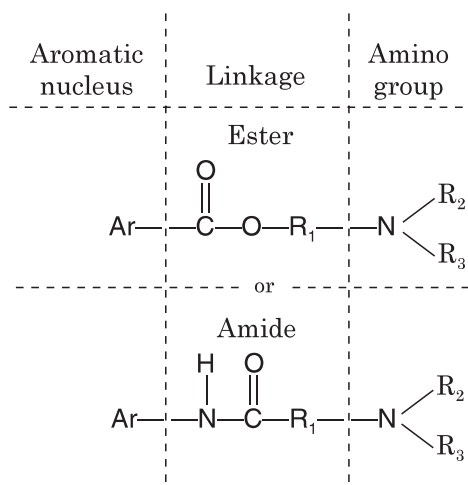

B. Amide Anesthetics

Amide anesthetics are metabolized in a more complex fashion in the liver. The status of the liver function is therefore significant. In a patient with a healthy liver, about 70% of the drug undergoes biotransformation. Patients with compromised liver function are unable to break down amide-type anesthetics at a normal rate, which leads to slower biotransformation and increased levels of local anesthetic in the blood as well as increased potential for toxicity.

CLASSIFICATION OF LOCAL ANESTHETICS

1. Natural agents : Cocaine
2. Synthetic nitrogenous drugs :
 - A. Derivatives of para amino benzoic acid : Procaine, Amethocaine, Benzocaine, Orthocaine.
 - B. Derivatives of acetanilide : Lidocaine
 - C. Derivatives of quinoline : Cinchocaine
3. Synthetic non-nitrogenous drugs : Benzyl alcohol, propanediol
4. Miscellaneous : Phenol, antihistamines.

MECHANISM OF ACTION OF THE LOCAL ANESTHETICS

- (a) The nerve fibre is a long cylinder surrounded by a semipermeable (allows only some substances to pass) membrane. This membrane is made up of proteins and lipids (fats). Some of the proteins apparently act as channels, or pores, for the passage of sodium and potassium ions through the membrane.
- (b) The movement of nerve impulses along a nerve fibre is associated with a change in the permeability of the membrane. The pores widen, and sodium ions (Na^+) move to the inside of the fibre. At the same time, potassium ions (K^+) diffuse out through other pores (see Figure). The entire process is called depolarization. Immediately after the nerve impulse has passed, the pores again become smaller. Sodium ions (Na^+) are now “pumped” out of the fibre. At the same time, potassium ions are actively transported into the fibre. The nerve membrane is then ready to conduct another impulse.

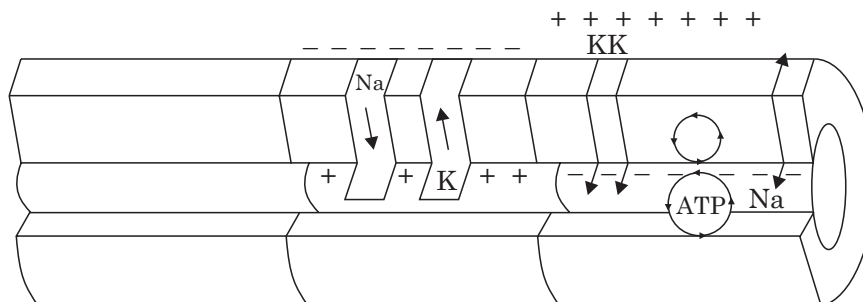

Mechanism of nerve impulse transmission.

- (c) Local anesthetics block depolarization of the nerve membrane to make the conduction of the nerve impulse impossible.
- (d) The local anesthetic effect lasts as long as the agent maintains a certain critical concentration in the nerve membrane. The local concentration needed to prevent conduction of the nerve impulse is much greater than the tolerable blood level.

EFFECT OF pH ON ACTION OF LOCAL ANESTHETICS

Anesthetics in solution exist both in an uncharged or base form and a charged or ion form. The proportion of each form of anesthetic is dependent upon the acidity of the environment (pH) and the tendency for the base form to transform into its ion form. A measure of the strength of this tendency is called the dissociation constant (pKa). Local anesthetics have pKa between 7.7 and 9.3, which permits them to exist in both ionized and non-ionized forms at physiologic pH 7.4. Only the base form of the anesthetic molecule can diffuse across the nerve membrane. Within the nerve only the ionized form of the molecule produces anesthesia by conduction blockade. As a rule, anesthetics with dissociation constants closest to the pH of normal tissues are most effective at producing profound anesthesia.

In the presence of tissue injury, inflammation, or infection, the local environment becomes acidic and pH may fall to 5.5 to 5.6 (purulent environment). This lower pH has a pro-

nounced effect on dissociation, lowering extraneural concentrations of base and, making adequate levels of intraneural anesthetic difficult to attain. The best anesthetic to use in this situation is mepivacaine.

% total drug at pH 7.4				
Agent	pKa	Onset	Cation	Free Base
Mepivacaine	7.7	Fast	67	33
Lidocaine	7.8	Fast	71	29
Etidocaine	7.9	Fast	75	25
Prilocaine	7.9	Fast	75	25
Bupivacaine	8.1	Intermediate	83	17
Procaine	9.1	Slow	98	2

HISTORY OF LOCAL ANESTHETICS

For centuries, natives of the Andean highlands have used the leaves of the coca bush (*Erythroxylon coca*) in which cocaine occurs in abundance, for its euphoric and stimulatory properties as well as its ability to prevent hunger.

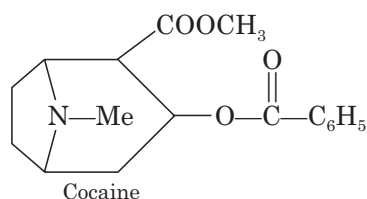

Albert Niemann in 1859-1860 was the first to isolate cocaine and discovered its anesthetic properties. Sigmund Freud studied the physiological actions of cocaine. In 1884 Karl Koller introduced cocaine into the clinical practice of medicine, using it as a topical anesthetic and pain relieving action for ophthalmological surgical procedures. William Halstead, who was a pioneer in regional nerve blockade, demonstrated the high abuse potential by addiction to cocaine. Abuse liability and frequent fatalities promoted a search for safer synthetic anesthetics. This search was initiated in 1892 by Alfred Einhorn. In 1905 he developed Procaine (Novocaine) the first injectable local anesthetic. This was the dental standard for over 40 years until the introduction of Lidocaine in 1948.

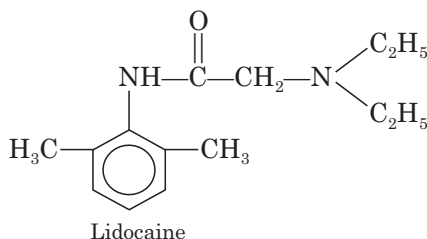

New amino ester local anesthetics were synthesized between 1891 and 1930, such as tropicaine, eucaine, holocaine, orthocaine, benzocaine and tetracaine. In addition, amino amide

local anesthetics were prepared between 1898 and 1972 including nirvaquine, procaine, chlorprocaine, cinchocaine, lidocaine, mepivacaine, prilocaine, efocaine, bupivacaine, etidocaine, and articaine. All of these drugs were less toxic than cocaine, but they had differing amounts of central nervous system (CNS) and cardiovascular (CV) toxicity. Bupivacaine is of special interest because of its long duration of action and history of clinical application.

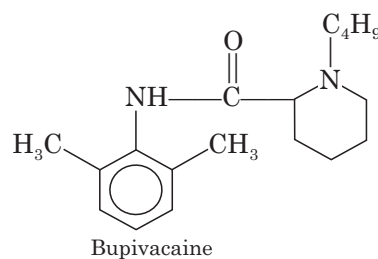

A major breakthrough in the chemistry of local anesthetic agents occurred in 1943 when Lofgren synthesized lidocaine, since it was not an ester but an amide derivative of diethylamino acetic acid. Concerning structure-activity relationships, local anesthetic agents, in general, possess the chemical arrangement of: aromatic portion—intermediate chain—amine portion. Changes in the aromatic or amine portion of a local anesthetic substance will alter its lipid/water distribution coefficient and its protein-binding characteristics which, in turn, will markedly alter the anesthetic profile.

The following are commonly used local anesthetics :

1. **Lidocaine.** (Xylocaine) 1948
2. **Mepivacaine.** 1957 (Comparatively a mild vasodilator; can be used effectively without vasoconstrictor)
3. **Bupivacaine.** 1957 (Long acting; Contraindicated in children and mentally handicapped persons due to the potential for self mutilation)
4. **Etidocaine.** 1971 (Long acting like Bupivacaine)
5. **Benzocaine.** Ester type topical anesthetic ; Not suitable for injection; Usually supplied as 14-20% concentration

Studies on the anesthetic activities and toxicity of the individual enantiomers of bupivacaine and mepivacaine generally indicate that the S-enantiomers are longer acting and less toxic than the R-enantiomers.

VII. PROPERTIES OF AN IDEAL LOCAL ANESTHETIC

The ideal properties of local anesthetics are :

1. The action of local anesthetic must be reversible
2. It must be non-irritating to the tissues and should not produce any secondary local reaction
3. It should have a low degree of systemic toxicity (Extremely low mortality rate estimated at 1 in 45 million administrations)
4. It should have sufficient potency to provide complete anesthesia

5. It should have rapid onset and be of sufficient duration to be advantageous
6. It should have sufficient penetrating properties to be effective as a topical anesthetic
7. It should be relatively free from producing allergic reactions
8. It should be stable in solution and undergo biotransformation readily within the body
9. It should be either sterile or capable of being sterilized by heat without deterioration

No local anesthetic in use fulfills all of these requirements, particularly regarding the duration of action

COCAINE

Source. Cocaine is an alkaloid obtained from the leaves of *Erythroxylon coca* and other species of *Erythroxylon* indigenous to Peru and Bolivia.

Chemistry. Cocaine is an ester of benzoic acid and a nitrogen containing base. It has the fundamental structure required for local anesthetic activity.

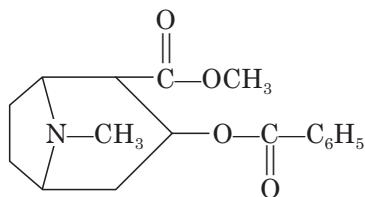

Properties :

1. It is colorless, odorless, bitter taste crystalline powder.
2. It is insoluble in water but soluble in alcohol, ether, and chloroform.
3. Cocaine forms a hydrochloride salt due to the presence of a tertiary nitrogen atom. Cocaine hydrochloride is freely soluble in water.
4. Cocaine melts at 98°C.

BENZOCAINE

Benzocaine (*Ethyl-4-amino benzoate*) is prepared by reduction of ethyl *p*-nitrobenzoate. The ethyl 4-nitrobenzoate is obtained from 4-nitrotoluene by oxidation and followed by esterification with ethyl alcohol in acidic media. The synthesis of benzocaine involves following chemical reactions.

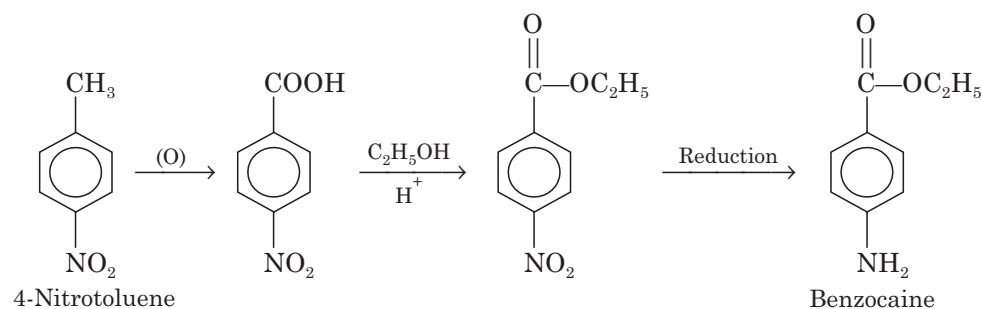

Properties :

1. Benzocaine is colorless, odorless, slightly bitter taste crystalline powder.
2. It is insoluble in water but soluble in ether, alcohol, and chloroform.
3. It melts at 90°C.

PROCAINE HYDROCHLORIDE (2-Diethylaminoethyl-p-amino benzoate)

Procaine hydrochloride is prepared by Hofmann's elimination reaction. It is prepared by heating 2-chloroethyl-4-aminobenzoate with diethyl amine under pressure.

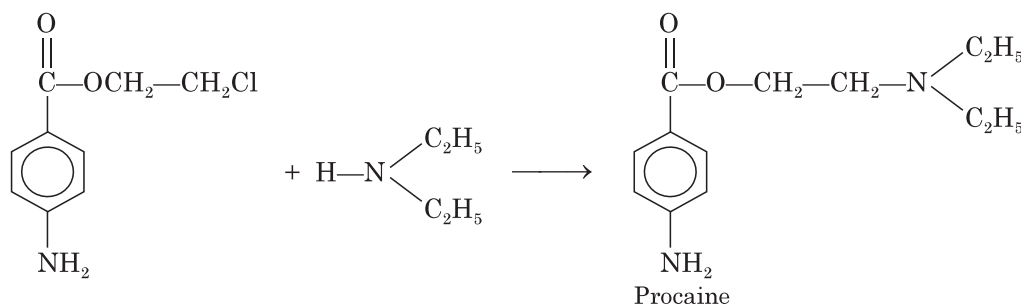
**Properties :**

1. Procaine hydrochloride is colorless, odorless, bitter taste crystalline powder.
2. It is soluble in water and alcohol.
3. It melts at 156°C.

LIGNOCAINE (or) LIDOCAINE (Diethyl aminoaceto-2, 6-xylidine)

Lignocaine is prepared by the following steps:

1. 2, 6-Dimethyl aniline (2, 6-xylidine) is acetylated with α -chloroacetylchloride to get the corresponding chloramide.

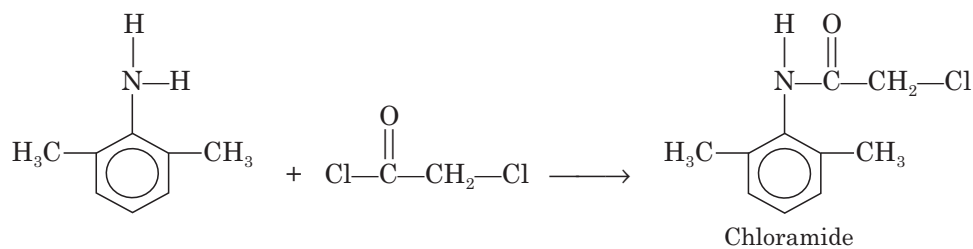

2. The above obtained chloramide is treated with diethyl amine to get lignocaine.

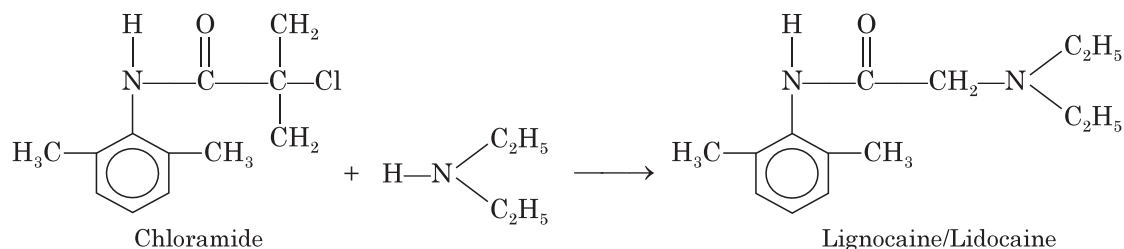
**Properties :**

1. It is colorless, odorless, slightly bitter taste crystalline powder.
2. It is insoluble in water and soluble in solvent ether.
3. It melts at 79°C.
4. It is also employed intravenously as an antiarrhythmic agent.

AMETHOCAINE

Amethocaine is prepared by the reaction of 4-n-butylaminobenzoic acid with 2-dimethyl amino ethanol.

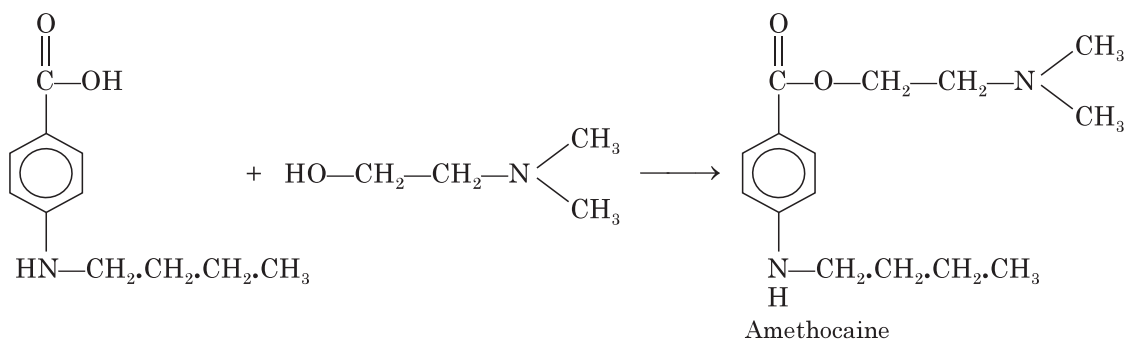
**Properties :**

1. It is colorless, odorless, slightly bitter taste crystalline powder.
2. It is insoluble in water but soluble in solvent ether.
3. It forms hydrochloride salt due to the presence of 2° nitrogen atom. Amethocaine hydrochloride is soluble in water and insoluble in ether.
4. Amethocaine hydrochloride melts at 155°C.

CINCHOCAINE

Cinchocaine is prepared from 2-hydroxy-4-quinoline carboxylic acid by the following steps :

1. Thionyl chloride converts the hydroxy groups of 2-hydroxy-4-quinoline carboxylic acid into the chloride.

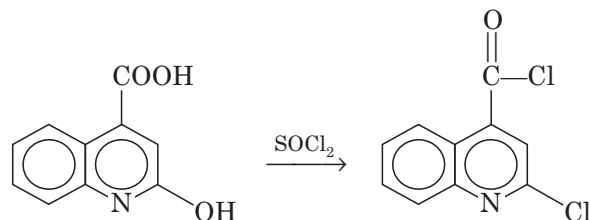

2. In the second step the above-obtained acid chloride is treated with N, N-diethyl ethylene diamine to get an amide.

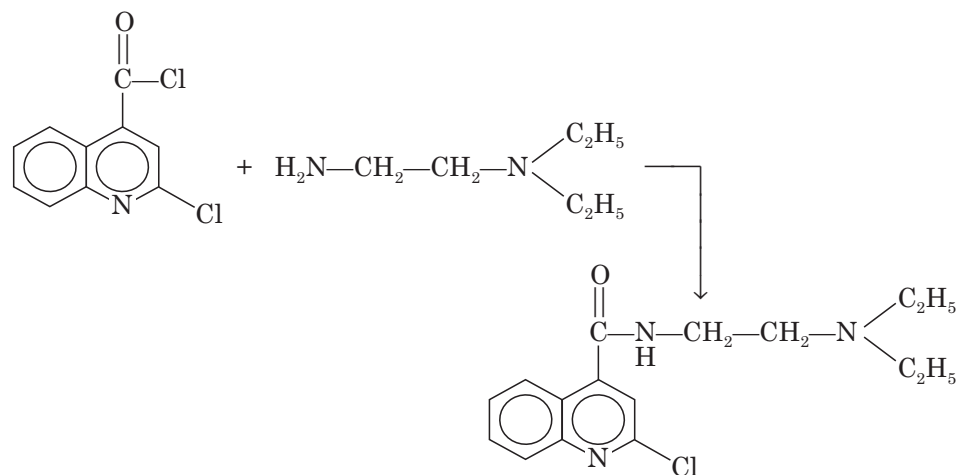

3. The above-formed amide is treated with sodium butoxide to replace chlorine by butoxy group to get cinchocaine.

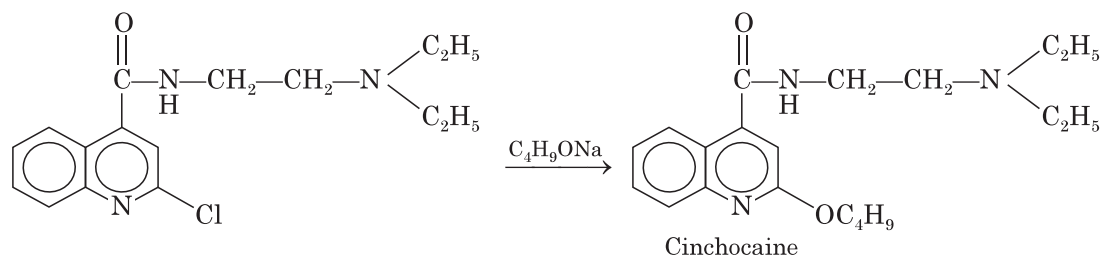

Properties :

1. Cinchocaine is available as hydrochloride salt.
2. It is colorless, hygroscopic crystalline compound.
3. It has rapid onset and long duration of action.

CYCLOMETHYCAINE

Cyclomethycaine is prepared by condensation of 4-cyclo hexyl oxybenzoic acid with piperidinol.

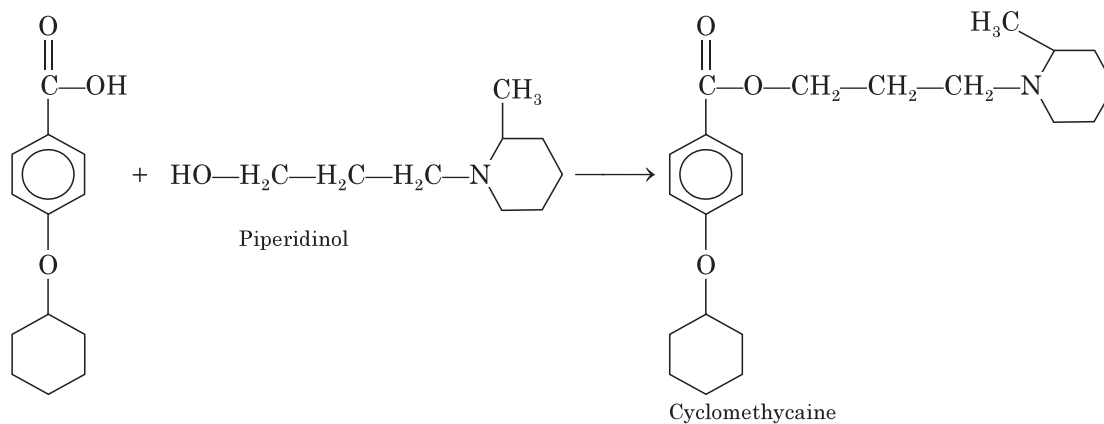

Cyclomethycaine has low intravenous and subcutaneous toxicity.

Properties :

1. Cyclomethycaine is available as cyclomethycaine sulphate.
2. It is white crystalline powder, sparingly soluble in water.
3. It is used as topical local anesthetic.

Bupivacaine :

Bupivacaine is 1-butyl-N-(2, 6-dimethylphenyl)-2-piperidinecarboxamide

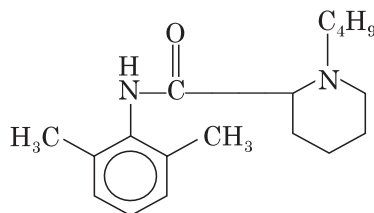

Properties :

1. Bupivacaine is available as bupivacaine hydrochloride.
2. It is white, odorless, water soluble crystalline powder.
3. It is long acting local anesthetic but more toxic.

20

Diuretics

INTRODUCTION

Diuretics are drugs, which increase the rate of urine flow. However, clinically useful diuretics also increase excretion of Na^+ and an accompanying anion (negatively charged ion) like Cl^- . Since NaCl is the major determinant of extracellular fluid volume, diuretics reduce extracellular fluid volume (decrease in oedema) by decreasing total body NaCl content. Although continued use of diuretic causes sustained net loss of Na^+ , the time course for this effect is limited by compensatory mechanisms including activation of the renin-angiotensin-aldosterone pathway and the sympathetic nervous system.

When blood is filtered at the glomerulus, the fluid which enters the proximal tubule is really the developing urine. As the tubular fluid passes down the tubule, solutes (Na^+ , K^+ , Cl^-) are removed from the fluid and returned to the blood (reabsorption). Diuretics inhibits the reabsorption of Na^+ ions, thereby reduces the quantity of the water in body fluids.

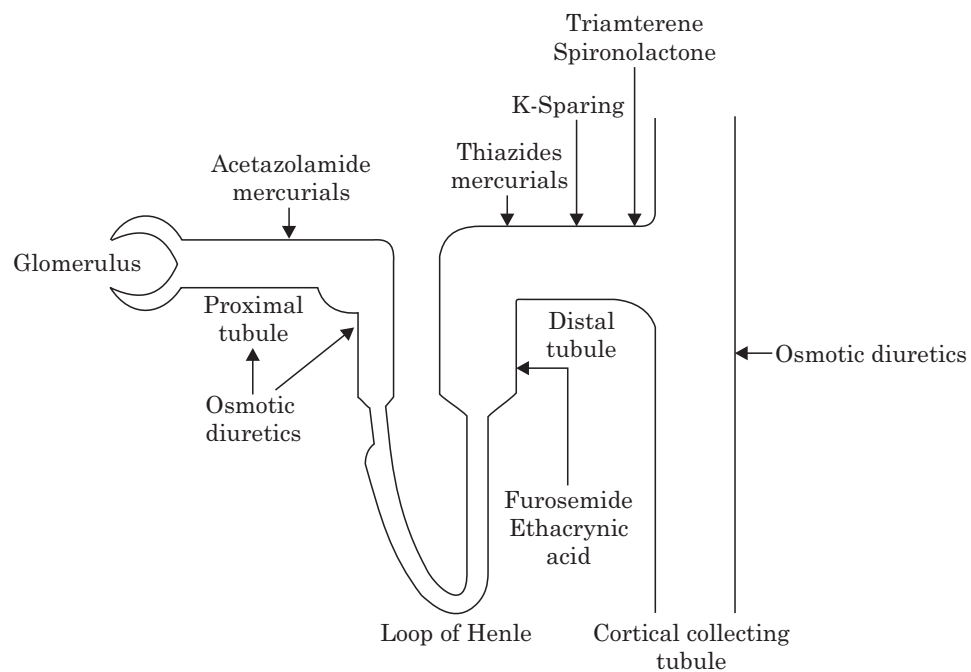

Site of action of diuretics.

CLASSIFICATION OF DIURETICS

The following classes of diuretics are therapeutically used:

Type	Example	Site of action	Mechanism
Carbonic anhydrase (CA) inhibitors	Acetazolamide	Proximal tubule	Inhibition of CA
Osmotic diuretics	Mannitol	Loop of henle ; Proximal tubule	Osmotic action
Loop diuretics	Furosemide	Loop of henle	Inhibition of Na ⁺ -K ⁺ 2Cl ⁻ symport
Thiazides	Hydrochlorothiazide	Distal convoluted tubule	Inhibition of Na ⁺ -Cl ⁻ symport
Potassium sparing diuretics 1. Na ⁺ channel Inhibitors 2. Aldosterone antagonist	Triamterene, Amiloride Spiranolactone	Collecting tubule	Inhibition of Na ⁺ channel Anti-diuretic hormone

CARBONIC ANHYDRASE (CA) INHIBITORS

Chemistry

Carbonic anhydrase (CA) inhibitors are derived from the sulphonamide antibacterials. Sulfonamide group ($-\text{SO}_2\text{NH}_2$) is essential for its activity. In 1937, Southworth observed that sulphanilamide not only had antibacterial activity but also produced systemic acidosis and an alkaline urine (HCO_3^- excretion). The carbonic anhydrase inhibitors must have unsubstituted sulphamoyl ($-\text{SO}_2\text{NH}_2$) group. Some potent CA inhibitors have an aromatic group (phenyl or heterocycle) attached to sulphamoyl group.

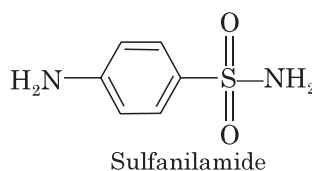

Mechanism of action

This class of diuretics inhibit carbonic anhydrase enzyme in the membrane and cytoplasm of the epithelial cells. The primary site of action is proximal tubules. These agents interfere with the reabsorption of HCO_3^- . HCO_3^- is reabsorbed in the proximal tubule and requires the activity of carbonic anhydrase. Intracellularly carbonic anhydrase (CA in the

diagram) converts H_2O and CO_2 to carbonic acid (H_2CO_3). H_2CO_3 dissociates into H^+ and HCO_3^- . The HCO_3^- is transported across the basolateral membrane. H^+ is secreted into the tubular lumen in exchange for Na^+ . The H^+ combines with a filtered HCO_3^- (using CA) to form H_2CO_3 , which immediately dissociates into H_2O and CO_2 that, is reabsorbed. Therefore, filtered bicarbonate is reabsorbed for every H^+ secreted. Carbonic anhydrase inhibitors, by blocking the enzyme, prevent the reabsorption of HCO_3^- .

Accumulation of HCO_3^- in the tubular lumen subsequently inhibits $\text{Na}^+ - \text{H}^+$ exchange and Na^+ reabsorption. The increase in sodium concentration in the tubular fluid may be compensated partially by increased NaCl reabsorption in later segments of the tubule. Thus, the diuretic effect of the carbonic anhydrase inhibitors is mild.

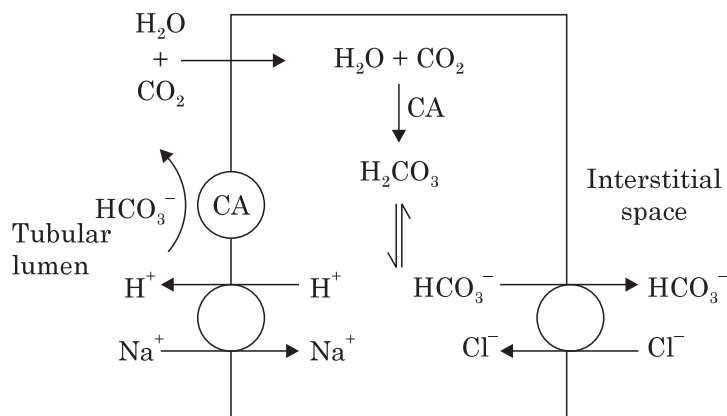

Synthesis of Acetazolamide. Acetazolamide is prepared by the following reactions :

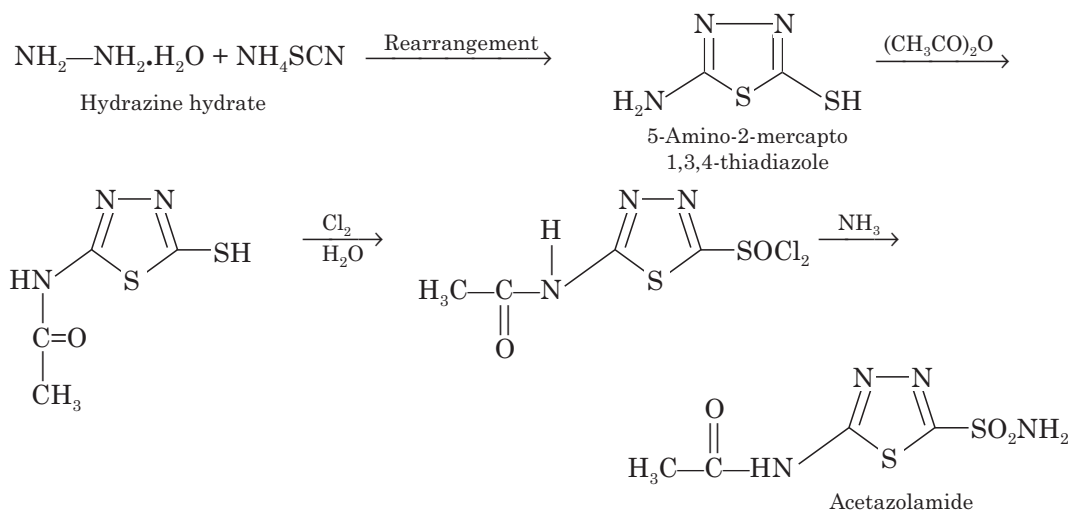

Structure-Activity Relationships :

1. All inhibit carbonic anhydrase activity.
2. Importantly, they have no antibacterial activity.
3. Substitution on the sulphamoyl group gives inactive compounds.

Drug	Structure
Acetazolamide	
Methazolamide	
Dichlorphenamide	

Uses

Carbonic anhydrase inhibitors are also used for non-diuretic indications, such as management of glaucoma, and as adjuvants for anti-epileptic drugs.

OSMOTIC DIURETICS

Chemistry. Osmotic diuretics are the agents that mobilise fluids by increasing the osmotic pressure in tubules. Some important osmotic diuretics are below :

Osmotic diuretics		
Drug	Structure	Oral Absorption
Glycerin		Orally active
Isosorbide		Orally active
Mannitol		Negligible
Urea		Negligible

Mechanism of Action

Osmotic diuretics are substances to which the tubule epithelial cell membrane has limited permeability. When administered (often in a large dosage), osmotic diuretics significantly increase the osmolarity of plasma and tubular fluid. The osmotic force thus generated prevents water reabsorption, and also extracts water from the intracellular compartment, expands extracellular fluid volume and increases renal blood flow resulting in reduced medulla tonicity. The primary sites of action for osmotic diuretics are the Loop of Henle and the proximal tubule where the membrane is most permeable to water.

LOOP DIURETICS OR HIGH-CEILING DIURETICS :

Chemistry. The diuretics that produce peak diuresis than other diuretics and act distinctly on renal tubular function (at loop of Henle) are called loopdiuretics or high-ceiling diuretics. There are two major classes of loop diuretics: 1) sulfonamide derivatives such as furosemide, bumetanide and torsemide; and 2) non-sulfonamide loop diuretic such as ethacrynic acid.

Drug	Structure
Furosemide	
Bumetanide	
Torsemide	
Ethacrynic acid	

Mechanism of Action

Loop diuretics inhibit reabsorption of NaCl and KCl by inhibiting the $\text{Na}^+ - \text{K}^+ - 2\text{Cl}^-$ symport in the luminal membrane of the thick ascending limb (TAL) of loop of Henle. As TAL is responsible for the reabsorption of 35% of filtered sodium, and loop diuretics are highly efficacious and are thus called high ceiling diuretics. The $\text{Na}^+ - \text{K}^+ - 2\text{Cl}^-$ symport and sodium pump together generate a positive lumen potential that drives the reabsorption of Ca^{++} and Mg^{++} , inhibitors of the $\text{Na}^+ - \text{K}^+ - 2\text{Cl}^-$ symport also inhibit reabsorption of Ca^{++} and Mg^{++} . Loop diuretics also have direct effects on vasculature including increase in renal blood flow, and increase in systemic venous capacitance.

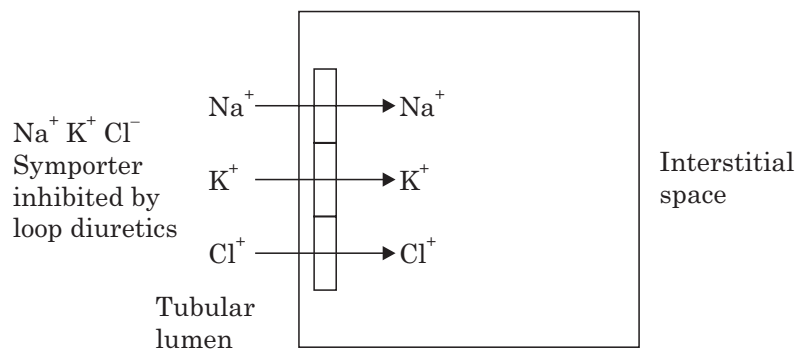

Structure-Activity Relationships of Ethacrynic acid :

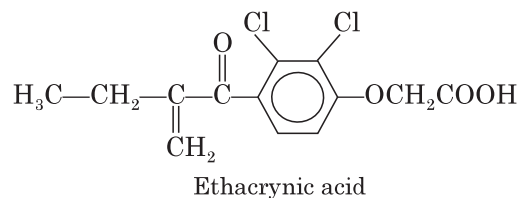

1. Designed to mimic mercurial diuretics.
2. Increased activity when a electron withdrawing group (*i.e.* Cl^-) is placed ortho to the unsaturated ketone (active site for sulfhydryl reactivity).
3. Ortho and meta positions substituted with chlorine produce most active compound.

Synthesis of ethacrynic acid. Ethacrynic acid is synthesized by the following chemical reactions :

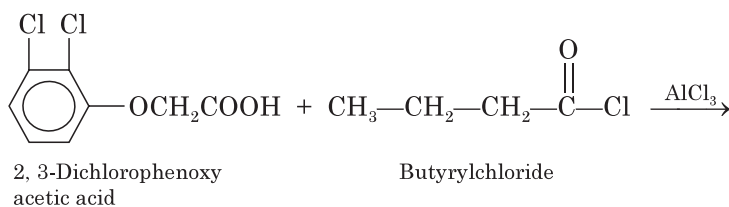

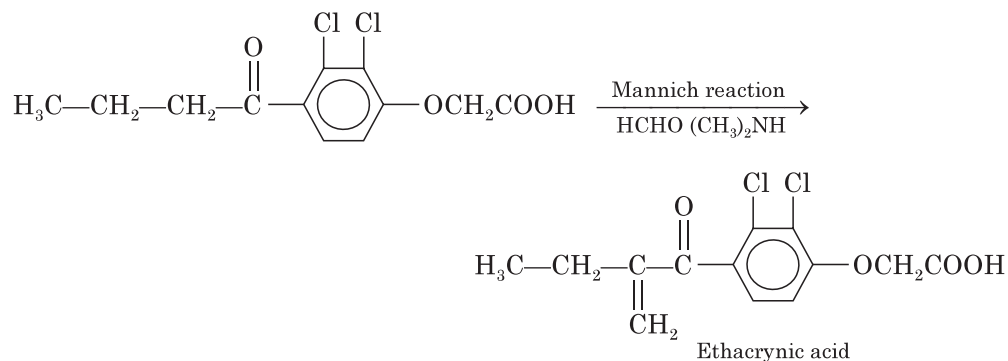

Synthesis of furosemide. Furosemide is synthesized by the following chemical reactions :

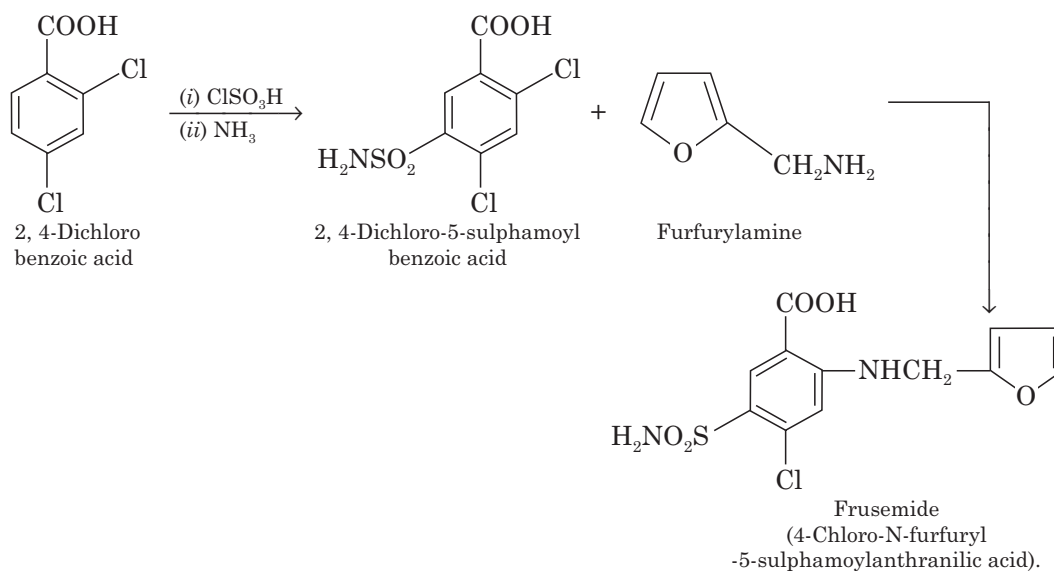

Uses of Loop diuretics. Particularly useful in acute left ventricular failure and pulmonary oedema because of quick onset and powerful diuretic action. They may also be used to treat hypercalcaemia.

THIAZIDES

Chemistry

Thiazides are also called benzothiadiazides. Thiazides are sulfonamide derivatives.

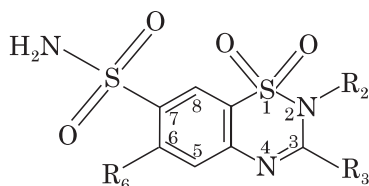

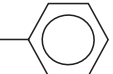
Drug	Structure
Chlorothiazide	$R_2 = H, R_3 = H, R_6 = Cl$
Hydrochlorothiazide	$R_2 = H, R_3 = H, R_6 = Cl$ (Saturated between C_3 and N_4)
Hydroflumethiazide	$R_2 = H, R_3 = H, R_6 = CF_3$ (Saturated between C_3 and N_4)
Bendroflumethiazide	$R_2 = H, R_3 = CH_2-$  , $R_6 = CF_3$ (Saturated between C_3 and N_4)

Some diuretics having similar pharmacological actions as thiazides but have the following structures (different from thiazides) :

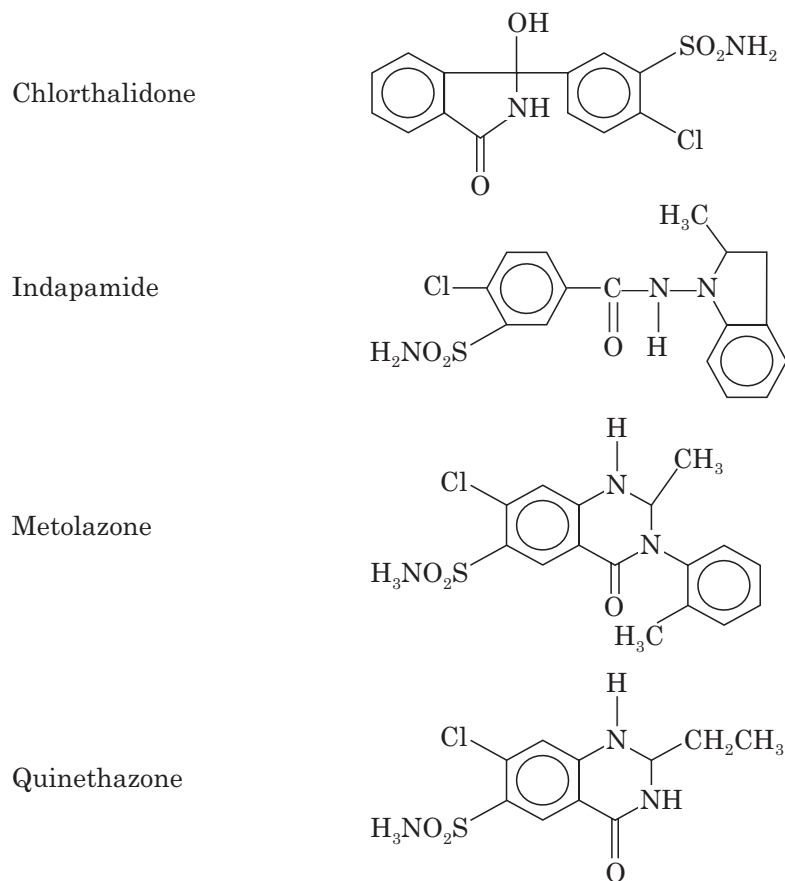

Mechanism of Action

Thiazides inhibit a $Na^+—Cl^-$ symport in the luminal membrane of the epithelial cells in the distal convoluted tubule. Thus, thiazides inhibit $NaCl$ reabsorption in the distal convoluted tubule, and may have a small effect on the $NaCl$ reabsorption in the proximal tubule.

Thiazides enhance Ca^{++} reabsorption in the distal convoluted tubule by inhibiting Na^+ entry and thus enhancing the activity of $\text{Na}^+ - \text{Ca}^{++}$ exchanger in the basolateral membrane of epithelial cells.

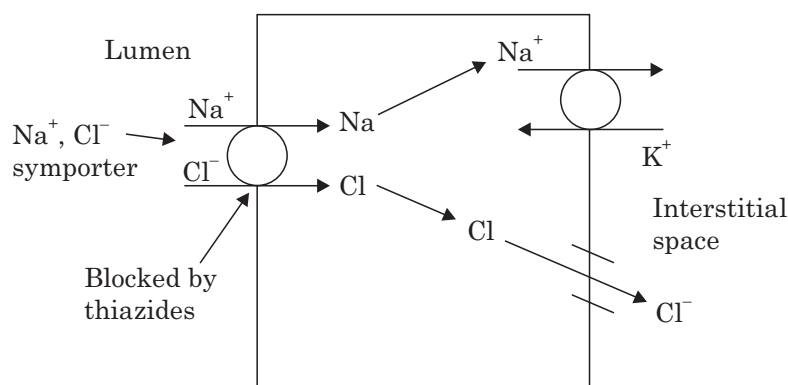

Structure-Activity Relationships of thiazides. These compounds are weakly acidic ;

1. H atom at N-2 is the most acidic due to the electron-withdrawing effects of the neighbouring sulfone group.
2. Sulfonamide group at C-7 provides an additional point of acidity in molecule but is less acidic than N-2 proton. A free sulfamoyl group at position 7 is essential for diuretic activity.
3. These acidic protons make possible the formation of a water-soluble sodium salt that can be used for I.V. dosing.
4. An electron-withdrawing group is essential at position 6.
5. The diuretic activity is enhanced by substitution at position 3.
6. Replacement of 6-Cl by 6- CF_3 does not change potency but allters duration of action.
7. Replacement of 6-Cl by electron-donating groups (*e.g.* CH_3) reduces diuretic activity.
8. Saturation of thiadiazine ring to give 3, 4-dihydro derivative and replacement replace or removal of sulfonamide group at position C-7 yields compounds with little or no diuretic activity.

Synthesis of bendroflumethiazide :

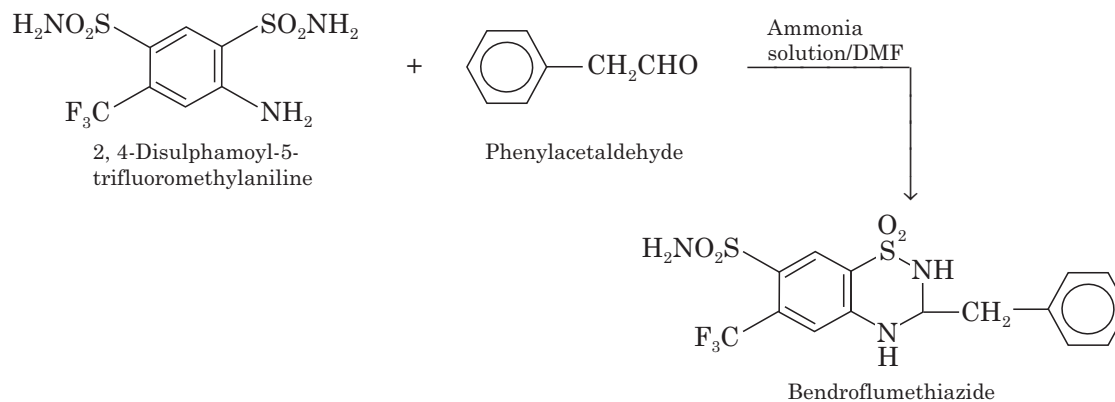

Synthesis of chlorothiazide. Chlorothiazide is synthesized by the following route :

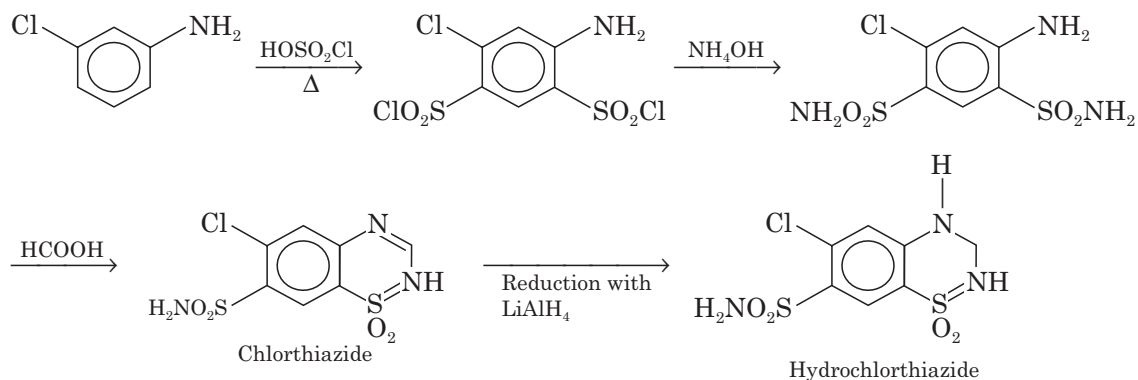

Uses of Thiazides. In mild cardiac failure, where the lesser diuretic effect may be more acceptable to the patient. Main use of thiazides is in antihypertensive therapy.

POTASSIUM-SPARING DIURETICS

1. Na^+ Channel Inhibitors. E.C. Taylor and J. Weinstock introduced aminopteridines as potassium-sparing diuretics. Ex : Triamterene and amiloride.

Chemistry. Amiloride and triamterene are the only two drugs in this class. The most active and successful compound of the class proved to be triamterene.

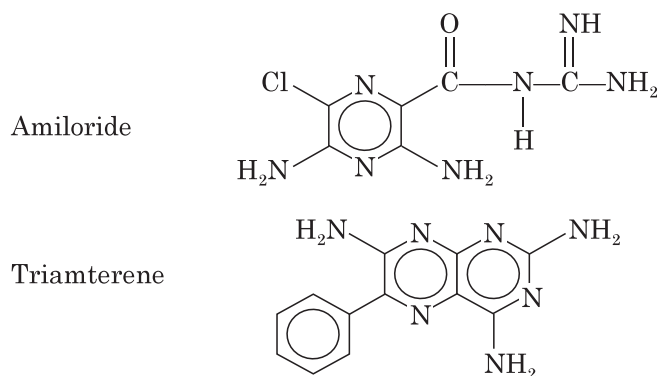

Mechanism of action. Amiloride and triamterene inhibit the sodium channel in the luminal membrane of collecting tubule and collecting duct. This sodium channel is critical for Na^+ entry into cells down the electrochemical gradient created by sodium pump in the basolateral membrane, which pumps Na^+ into interstitium. This selective transepithelial transport of Na^+ establishes a luminal negative transepithelial potential which in turn drives secretion of K^+ into the tubule fluid. The luminal negative potential also facilitates H^+ secretion via the proton pump in the intercalated epithelial cells in collecting tubule and collecting duct. Inhibition of the sodium channel thus not only inhibits Na^+ reabsorption but also inhibits secretion of K^+ and H^+ , resulting in conservation of K^+ and H^+ .

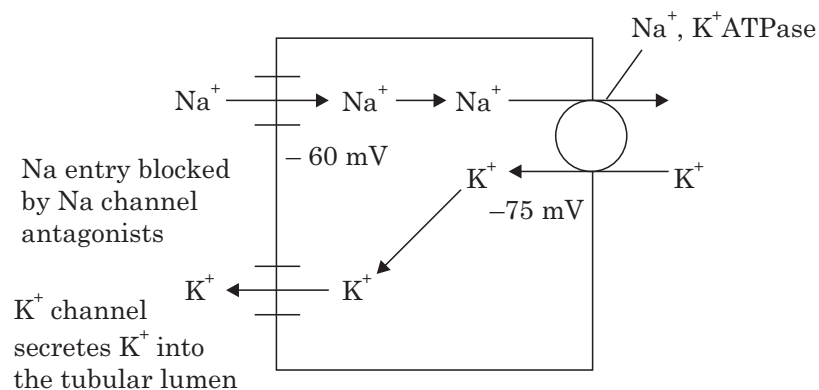

2. Aldosterone Antagonists

Chemistry. Spironolactone is the only available aldosterone antagonist. A metabolite of spironolactone, canrenone, is also active and has a half-life of about 16 hours.

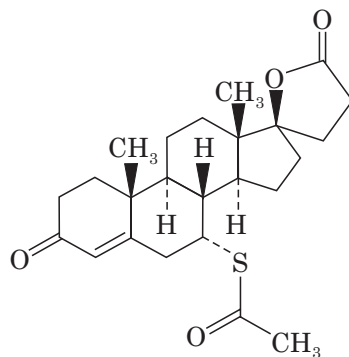

Mechanism of action. Aldosterone, by binding to its receptor in the cytoplasm of epithelial cells in collecting tubule and duct, increases expression and function of Na⁺ channel and sodium pump, and thus enhances sodium reabsorption (see “Na⁺ channel inhibitors” above). Spironolactone competitively inhibits binding of aldosterone to its receptor and abolishes its biological effects.

21

Hypoglycemic Agents

INTRODUCTION

Pancreas secrete digestive enzymes, glucagon and insulin. An isolated group of cells within pancreas is called as islets of langerhans. These cells are divided into three types as α cells (secretes glucagon), β cells (secretes insulin) and γ cells (secretes somatostatin). Insulin plays an important role in digestion and utilization of food substances. It is essential for the phosphorylation of glucose to glucose-6-phosphate. Glucose-6-phosphate is further catabolized to give energy. In some individuals glucose level in blood increases due to lack of sufficient insulin. This condition is called hyperglycemia. The disease is known as diabetes mellitus. Some of the more important symptoms associated with the disease are polydipsia, polyurea, ketnaemia, and ketourea. Most patients can be classified clinically as having either insulin-dependent diabetes mellitus (Type-I diabetes) or non-insulin-dependent diabetes mellitus (Type-II diabetes). Type-I diabetes is an auto-immune disease caused by the destruction of pancreatic islet cells. In Type-II diabetes the cause of hyperglycemia is a combination of insulin resistance and a loss of secretory function by pancreatic β -cells. People who have diabetes are two to four times more likely to die from heart disease or have a stroke than people who do not have diabetes.

To date, there is no known cure for Type I (insulin dependent) diabetes. Hypoglycemic agents lower the blood sugar and are used to treat the symptoms of diabetes mellitus.

CLASSIFICATION OF HYPOGLYCEMIC AGENTS

Type II diabetes mellitus develops most often in people over 40 years of age, and obesity increases the risk of developing it. While diet and exercise are recommended as the first line of defense, many individuals are unable to control the disease through these means alone. For these people, one or more oral antidiabetic agents may be used. Some people with type II diabetes require insulin to control the disease. Oral antidiabetic drugs act in one or more of the following :

1. Stimulating the release of insulin by the pancreas
2. Slowing the absorption of glucose from the intestines
3. Decreasing glucose synthesis and release by the liver
4. Making cells more sensitive to insulin (*e.g.*, muscle and liver).

The hypoglycemic agents are classified into the following two main categories. They are :

- A. Insulin and its preparations

B. Synthetic compounds(Oral hypoglycemic agents) : The oral hypoglycemic agents are further classified as :

1. Sulfonyl urea derivatives. Ex: Chlorpropamide, tolbutamide, glibenclamide, glipizide and dichlorphenamide.

2. Biguanide derivatives. Ex: Phenformin, metformin.

SPECIFIC HYPOGLYCEMIC AGENTS

INSULIN. Insulin was the first hormone identified in 1920's by Banting and Best. They discovered insulin by tying a string around the pancreatic duct of several dogs. When they examined the pancreas of these dogs several weeks later, all of the pancreatic digestive cells were died and were absorbed by the immune system and the only thing left was thousands of pancreatic islets. They then isolated the protein from these islets and discovered insulin.

Sources of Insulin

The first successful insulin preparations came from cows (bovine)and later from pigs (porcine). Bovine and porcine insulin worked very well for the majority of patients, but some could develop an allergy or other types of reactions to the foreign protein (a foreign protein is a protein which is not native to humans). In the 1980's technology had advanced to the point where we could make human insulin. The advantage would be that human insulin would have a much lower chance of inducing a reaction because it is not a foreign protein. The technology, which made this approach possible, was the development of recombinant DNA techniques. In simple terms, the human gene, which codes for the insulin protein was cloned (copied) and then put inside of bacteria. A number of operations were performed on this gene to make the bacteria to constantly make insulin. Big vats of bacteria now make tons of human insulin. From this, one can isolate pure human insulin.

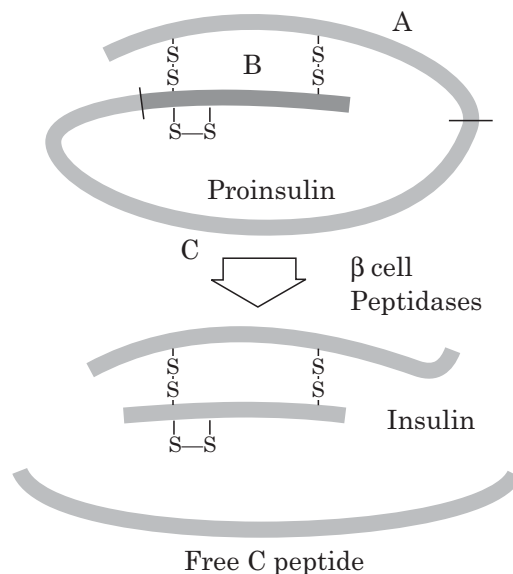

Isolation of Insulin

Isolation of insulin from animal pancreas involves the following steps :

- (i) Mince the pancreas of slaughtered animal and extract with 80% ethanol containing small amounts of phosphoric acid (to adjust pH to 3)
- (ii) Centrifuge the extract to separate proteins and fats
- (iii) Raise the pH of extract to 8.0 by adding ammonia solution and filter
- (iv) Acidify and evaporate the filtrate to remove fatty material
- (v) Add picric acid to ethanolic solution to precipitate insulin as insulin picrate
- (vi) Dissolve insulin picrate in acetone and reprecipitate as hydrochloride salt
- (vii) Insulin is further purified by chromatography

Structure of Insulin

The minimum molecular weight of insulin is about 6000. Dinitro phenyl hydrazine (N-terminal amino acid determination method) showed the presence of two N-terminal amino acid residues *i.e.* glycine, phenylalanine. Thus insulin contains two peptide chains.

Insulin was oxidized with performic acid. This produced two peptides, which were separated by electrophoresis. The two peptide chains referred to as the A chain and B chain.

The peptide with N-terminal glycine residue was called the A-chain and that with the N-terminal phenylalanine residue was called B-chain. Each chain was subjected to hydrolysis (with acids or enzymes). The products of hydrolysis were separated and examined by DNP method.

The chain-A contains 21 amino acid residues and the chain-B contains 30 amino acid residues. In chain-A four cysteine acid residues and chain-B two residues were present. Two disulphide bonds connecting these two chains, further chain-A contains one intra disulphide bond.

These interactions have important clinical ramifications. Monomers and dimers readily diffuse into blood, whereas hexamers diffuse very poorly. Hence, absorption of insulin preparations containing a high proportion of hexamers is delayed and slow. This problem, among others, has stimulated development of a number of recombinant insulin analogs. The first of these molecules to be marketed—called insulin lispro—is engineered such that lysine and proline residues on the C-terminal end of the B chain are reversed; this modification does not alter receptor binding, but minimizes the tendency to form dimers and hexamers.

Although the amino acid sequence of insulin varies among species, certain segments of the molecule are highly conserved, including the positions of the three disulfide bonds, both ends of the A chain and the C-terminal residues of the B chain. These similarities in the amino acid sequence of insulin lead to a three dimensional conformation of insulin that is very similar among species, and insulin from one animal is very likely biologically active in other species. Indeed, pig insulin has been widely used to treat human patients. The structure of insulin is as below :

The structure of insulin differs slightly from different sources, but all show identical hormonal activity.

Biosynthesis of Insulin

Insulin is synthesized in significant quantities only in β cells in the pancreas. The insulin mRNA is translated as a single chain precursor called proinsulin, and removal of its signal peptide during insertion into the endoplasmic reticulum generates proinsulin.

Proinsulin consists of three domains: an amino-terminal B chain, a carboxy-terminal A chain and a connecting peptide in the middle known as the C peptide. Within the endoplasmic reticulum, proinsulin is exposed to several specific endopeptidases, which excise the C peptide, thereby generating the mature form of insulin. Insulin and free C peptide are packaged in the Golgi into secretory granules, which accumulate in the cytoplasm.

When the β cell is appropriately stimulated, insulin is secreted from the cell by exocytosis and diffuses into islet capillary blood. C peptide is also secreted into blood, but has no known biological activity.

Insulin Preparations

Human insulin is absorbed more quickly than beef or pork insulin. Thus the duration of action of human insulin is shorter. If insulin preparations were administered orally, it would be degraded in gastrointestinal tract. Therefore, insulin must be administered by injection (IV or subcutaneous). The following insulin preparations are used for the treatment of diabetes.

Crystalline zinc insulin. It is purified insulin crystallized as a zinc salt. It is administered subcutaneously and lowers the blood sugar within minutes. Hence it is known as rapid action insulin.

Semilente insulin. It is a suspension of amorphous insulin, which is also administered subcutaneously. It is another example for rapid action insulin.

Isophane insulin. It is a suspension of crystalline zinc insulin with the positively charged peptide mixture called protamine. Its duration of action is intermediate between crystalline zinc insulin and protamine zinc insulin. This is due to delayed absorption of insulin because of conjugation of insulin with protamine to form less soluble complex.

Lente insulin. It is a mixture of 30% of semilente insulin and 70% ultralente insulin. It is another intermediate action insulin that is administered subcutaneously.

Protamine zinc insulin. It is a prolonged action insulin preparation. It produces maximum therapeutic effect in 24 hours. It is prepared by mixing crystalline zinc insulin with protamine.

Extended insulin zinc suspension. It is poorly soluble crystalline zinc insulin. This preparation has a delayed onset and prolonged duration of action.

Storage

Insulin in powder form should be stored in airtight containers protected from light. The injections are required to be stored in a refrigerator at 2 to 8°C and not allowed to freeze.

The insulin receptor and mechanism of action

Like the receptors for other protein hormones, the receptor for insulin is embedded in the plasma membrane. The insulin receptor is composed of two alpha subunits and two beta subunits linked by disulfide bonds. The alpha chains are entirely extracellular and house insulin binding domains, while the linked beta chains penetrate through the plasma membrane.

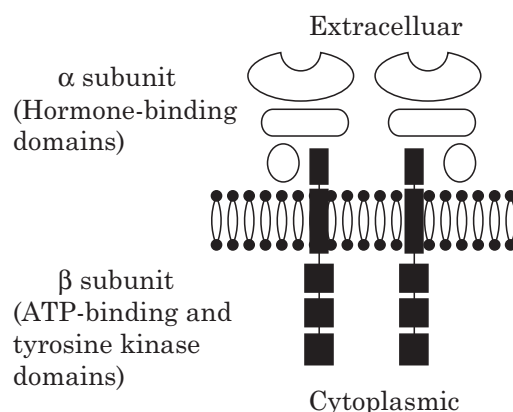

The insulin receptor is a tyrosine kinase. In other words, it functions as an enzyme that transfers phosphate groups from ATP to tyrosine residues on intracellular target proteins. Binding of insulin to the alpha subunits causes the beta subunits to phosphorylate themselves (autophosphorylation), thus activating the catalytic activity of the receptor. The activated receptor then phosphorylates a number of intracellular proteins, which in turn alters their activity, thereby generating a biological response.

B. ORAL HYPOGLYCEMIC AGENTS. Because of the ineffectiveness of insulin through oral route in the treatment of diabetes mellitus, search was made for the compounds, which could proved to be effective orally. The following oral hypoglycemic agents are used to treat diabetes mellitus.

SULFONYL UREAS

In 1942, Jan bon and his colleagues observed that some sulfonamides exhibited useful sulfonyl hypoglycemic effect. This led to the synthesis of some clinically useful sulfonyl ureas.

To date more than 12000 sulfonyl ureas have been prepared and many have been found to be extremely useful.

Ex: Tolbutamide, chlorpropamide, tolazamide and acetohexamide are first generation sulfonylureas while glyburide and glipizide are of second generation.

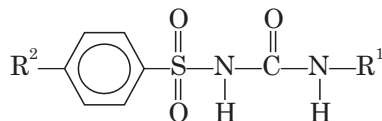

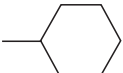
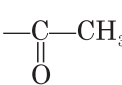
Chlorpropamide	$R^1 = \text{CH}_2\text{CH}_2\text{CH}_3$; $R^2 = \text{Cl}$
Tolbutamide	$R^1 = \text{CH}_2\text{CH}_2\text{CH}_2\text{CH}_3$; $R^2 = \text{CH}_3$
Acetohexamide	$R^1 = $  ; $R^2 = $ 

The sulfonyl ureas are rapidly absorbed from the GI tract. Hydroxylation of the aromatic ring appears to be the most favored metabolic pathway for these sulfonyl ureas. The hydroxylated derivatives have much lower hypoglycemic activity than the parent compounds.

The alkyl group of the sulfonyl urea also undergoes hydroxylation. For example, glipizide is metabolized to cis-3-hydroxy-glipizide and trans-4-hydroxy-glipizide. These metabolites have approximately ~15% of the hypoglycemic activity of the parent compound. This is understandable taking into consideration their highly hydrophobic nature. Due to this nature they are highly protein bound. Second generation sulfonyl ureas due to their greater hydrophobic character are effective over a longer duration of action.

Structure—Activity Relationships :

- The benzene ring should contain one substituent, preferably at the para position. The substituents that seem to enhance hypoglycemic activity are methyl, amino, acetyl, chloro, bromo, methylthio, and trifluoromethyl groups.
- Compounds with p-(β -arylcarboxamidoethyl) substituents (the second generation agents) have better activity than the first generation agents. It is believed that this is because of a specific distance between the nitrogen atom of the substituent and the sulfonamide nitrogen atom.
- The group attached to the terminal nitrogen should be of certain size and should impart lipophilic properties to the molecule. The N-methyl are inactive, N-ethyl have low activity, while N-propyl to N-hexyl are most active. Activity is lost if N-substituent contains 12 or more carbons.

Biochemical Mechanism of Action. The hypoglycemic action of the sulfonyl ureas is usually attributed to their ability to stimulate the release of insulin from the pancreatic islets. It is proposed that the sulfonyl ureas bring about their increase in insulin release through binding to receptors on the islets β -cell membrane that are linked to closure of the channels that facilitate the passive efflux of K^+ from the cell. These K^+ channels are responsive to ATP/ADP ratio and close when the ratio increases because of an increase in glucose metabolism. Binding of sulfonyl ureas to their receptor leads to the closure of the potassium channels which opens calcium channels for influx of Ca^{+2} ions into the cytoplasm. The increase in cytosolic Ca^{+2} activates the effector system that leads to the translocation of the secretory granules to the exocytotic sites at the plasma membrane at which insulin is released. Thus sulfonyl ureas are effective only if the secretion of insulin from the β -cells not completely impaired but is inefficient.

CHLOPROPAMIDE

Chemistry. Chlorpropamide is a derivative of benzenesulphonamide. The synthesis of chlorpropamide involves the following steps :

(a) Chlorobenzene on reaction with chlorosulfonic acid yields 4-chlorobenzene sulphonyl chloride.

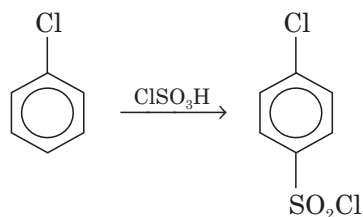

(b) The 4-chlorobenzene sulphonyl chloride on reaction with ammonia converts to sulfonamide.

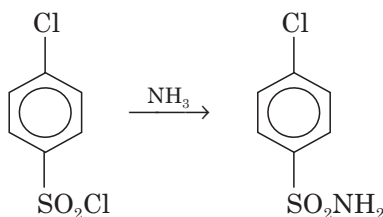

(c) The above-formed sulfonamide on refluxation with ethylchloroformate produces N-4-chlorophenyl sulfonyl carbamate, which on condensation with n-propylamine yields chlorpropamide.

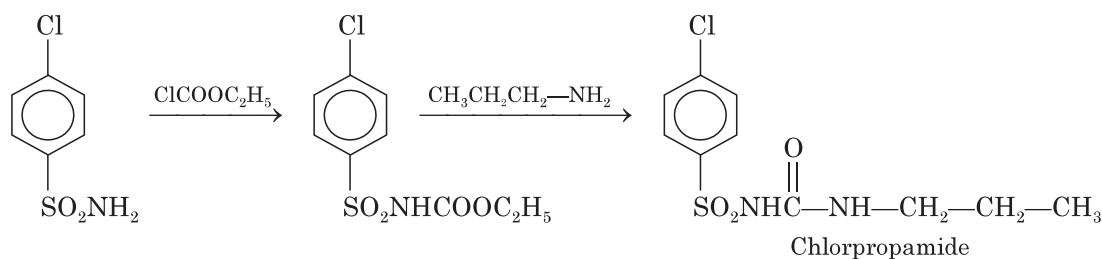

Properties. Chlorpropamide is a colorless, odorless, crystalline powder. It is insoluble in water, alcohol, moderately soluble in chloroform, ether.

Mechanism of action. Chlorpropamide develops hypoglycemic effect by the following mechanisms ;

- (i) It stimulates insulin release from the β -cells of the pancreas
- (ii) It reduces serum glucagon levels
- (iii) It also increases binding of insulin to receptors and target tissues

Uses. It is used for the treatment of non-insulin dependent diabetes mellitus

TOLBUTAMIDE

Chemistry. Tolbutamide is another sulphonylurea derivative. It is prepared by condensation of sodium salt of toluene-p-sulphonamide with n-butylisocyanate. This reaction is carried out in acidic medium.

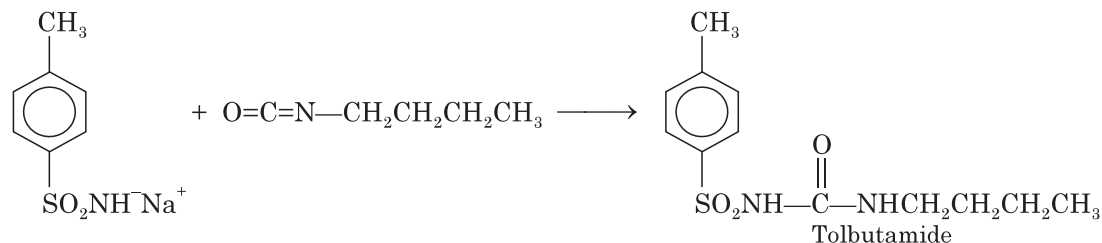

Properties. Tolbutamide is a colorless, odorless, slightly bitter taste crystalline powder. It is insoluble in water but soluble in alcohol and chloroform and melts at 126°C .

Mechanism of action. Tolbutamide releases somatostatin from islet γ -cells of pancreas. The somatostatin in turn influence the release of insulin, thus produces antidiabetic effect.

Uses. Tolbutamide is used as an oral hypoglycemic agent for the treatment of mild uncomplicated diabetes mellitus.

GLIBENCLAMIDE

Chemistry. Glibenclamide is 5-Chloro, N-[2-[4-[[(cyclohexylamino) carbonyl]amino] sulfonyl] phenyl] ethyl], 2-methoxy benzamide. It is prepared by condensation of 5-chloro-2-methoxy benzoyl chloride with 4-amino ethyl benzene sulphonamide, followed by treatment with hexyl isocyanate.

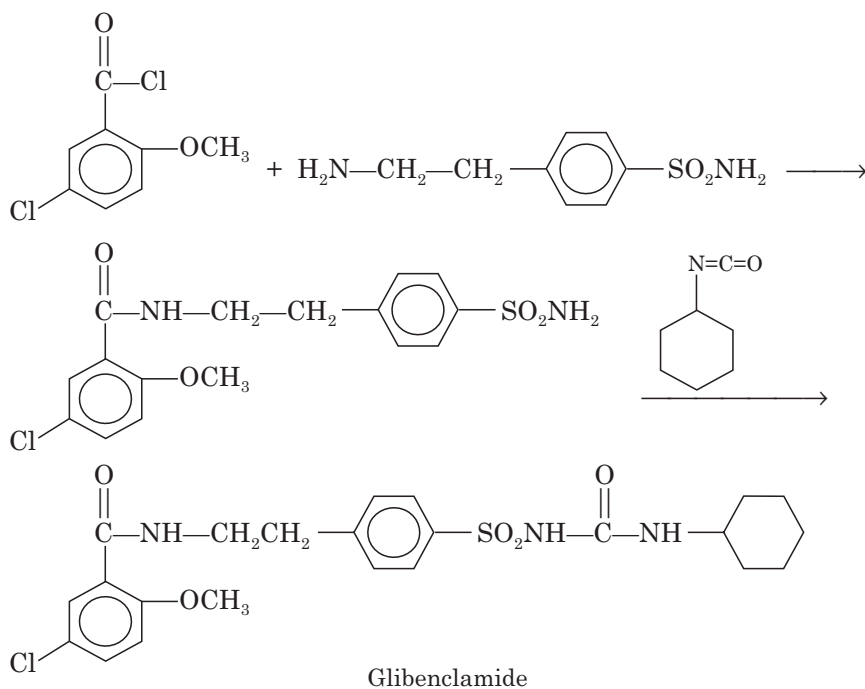

Properties. It is a colorless crystalline powder. It is insoluble in water.

Mechanism of action. It produces hypoglycemic effect by stimulating the release of insulin from β -cells of pancreas and by increasing the sensitivity of peripheral tissues to insulin. It is more potent than tolbutamide.

Uses. It is used to control hyperglycemia in type-II diabetes mellitus.

GLIPIZIDE

Chemistry. Glipizide is 1-cyclohexyl 3-[[p-[2-methylpyrazine carboxamido) ethyl] phenyl]sulfonyl]urea. It is a cyclohexyl sulfonyl urea analogue. Glipizide is synthesized by condensing 5-methylpyrazine-2-carboxylic acid and 4-(2-aminoethyl) benzene sulfonamide, followed by reaction with cyclohexyl isocyanate in basic conditions.

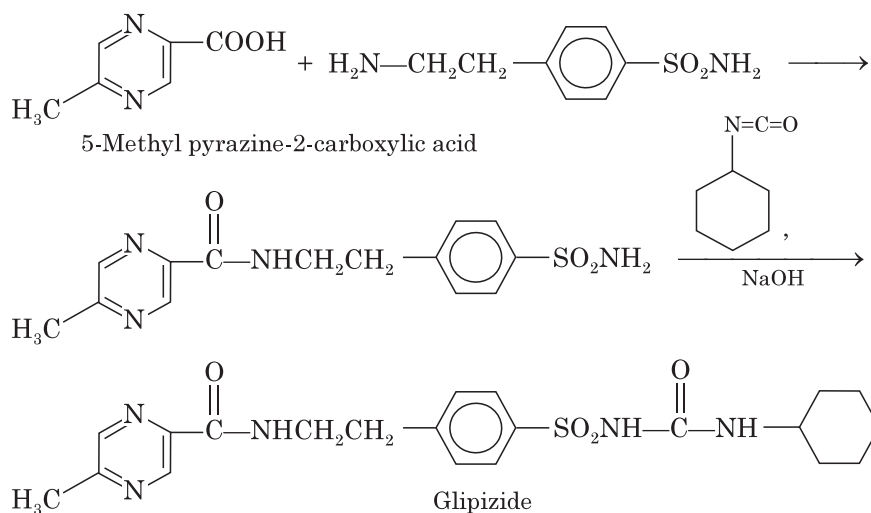

Properties. It is available as a colorless crystalline powder and is insoluble in water.

Mechanism of action. It produces hypoglycemic effect by stimulating the release of insulin from β -cells of pancreas and by increasing the sensitivity of peripheral tissues to insulin.

Uses. It is used to control hyperglycemia in type-II diabetes mellitus.

BIGUANIDES

In 1918 guanidine [$\text{NH}_2\text{C}(=\text{NH})\text{NH}_2$], lowered blood sugar levels. This led to introduction of biguanides as oral hypoglycemic agents. In 1957 biguanides were prepared and tested.

A biguanide refers to a structure where two guanidine $\left[\begin{array}{c} \text{NH} \\ \parallel \\ \text{NH}_2\text{C}-\text{NH}_2 \end{array} \right]$ molecules are linked through common $-\text{NH}-$ link. *Ex:* Phenformin, metformin.

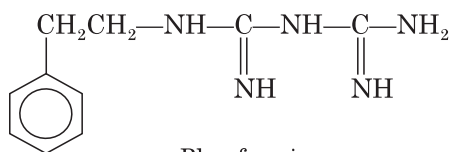

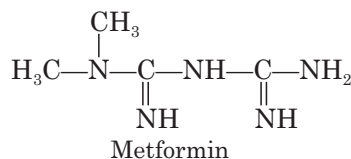

Biguanides increase insulin sensitivity in liver and muscle, inhibit glucose synthesis and release by the liver, and enhance the ability of tissues to take up glucose.

PHENFORMIN

Chemistry. It is a biguanide. Chemically phenformin is 1-phenethyl biguanide. It is prepared by refluxing cyanoguanidine with phenethylamine hydrochloride.

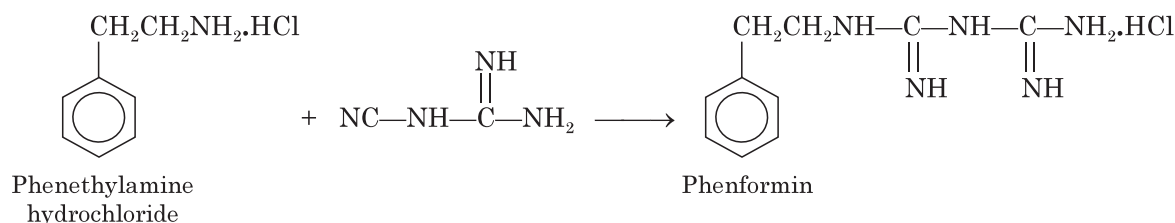

Properties. It is colorless, odorless, bitter taste crystalline powder. Phenformin is available as a hydrochloride salt, which is soluble in ether and chloroform. It should be stored in airtight containers.

Mechanism of action. Biguanides mechanism of action is uncertain, however they lower blood glucose concentrations by producing insulin like effects on several tissues. They also suppress gluconeogenesis, stimulate glycolysis and inhibit glucose absorption from the intestine.

Uses. It is administered either alone or in combination with other hypoglycemic agents in the treatment of diabetes mellitus. Phenformin is also used in the treatment of occlusive vascular disease, Raynaud's syndrome and rheumatoid arthritis along with ethylestrenol.

METFORMIN

Chemistry. Metformin is another biguanide derivative. It is often prescribed for obese people with type 2 diabetes, and does not cause weight gain. Chemically metformin is N, N-dimethyl biguanide. It is prepared by refluxing cyanoguanidine with dimethylamine hydrochloride at 135°C.

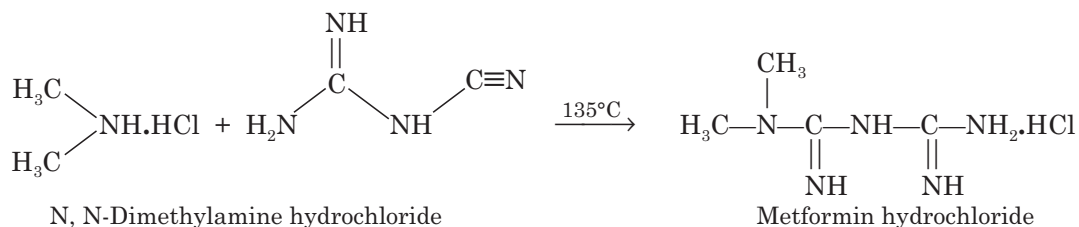

Properties. It is colorless crystalline powder. Metformin is freely soluble in water and is hygroscopic in nature.

Mechanism of action. Metformin is antihyperglycemic agent. The main causes for reduced glucose levels are :

- (i) Increase in insulin action in peripheral tissues
- (ii) Reduced hepatic glucose output due to inhibition of gluconeogenesis
- (iii) Reduce the absorption of glucose from intestine

Uses. Metformin is used as antihyperglycemic agent. It is often given in combination with sulfonylureas.

Newer oral hypoglycemic agents :

Thiazolidinones. Thiazolidinones are a group of structurally related *peroxisome* proliferator-activated receptor γ (PPAR γ) agonists with antidiabetic actions *in vivo*. These were developed as oral antidiabetic agents in 1997 (commercially known as glitazones). The first, troglitazone was taken off the market in 1999 because of its hepatic toxicity

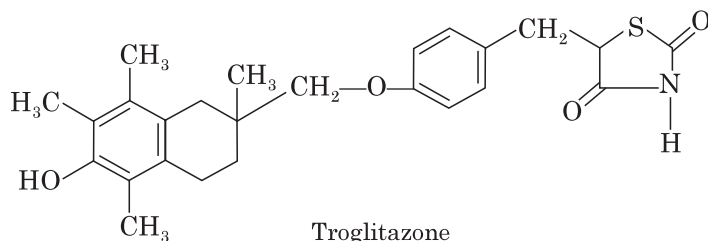

Rosiglitazone and pioglitazone are now available for clinical use and are extremely potent in reducing insulin resistance.

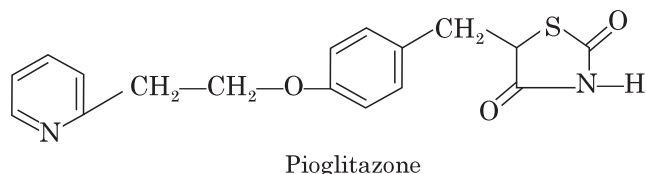
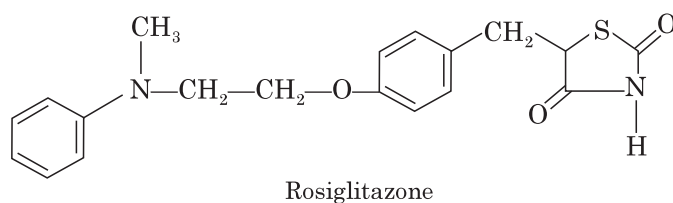

The primary effect of thiazolidinones is peripheral, with increasing insulin sensitivity and increased glucose uptake. They do not stimulate pancreas to produce more insulin. Besides their effect in lowering the blood glucose levels, both drugs also have notable effects on lipids.

Benzoic acid derivatives. Repaglinide and nateglinide are important benzoic acid derivatives possessing oral antidiabetic activity. They stimulate insulin secretion in a different way from the sulfonylureas.

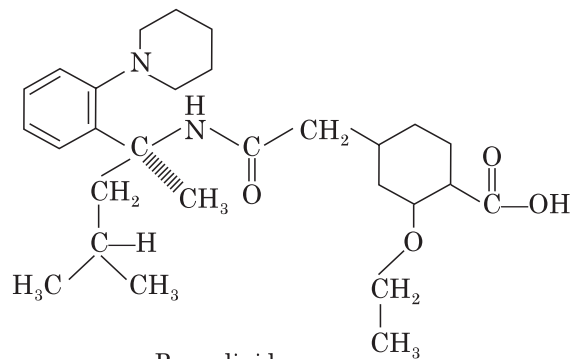

Repaglinide is rapidly absorbed and quickly metabolized in the body. It also has little effect on lipids and can, like the sulfonylureas cause weight gain.

Alpha-glucosidase inhibitors. Glucosidase inhibitors act in the intestine to block the action of enzymes that are responsible for breaking down complex carbohydrates into simple sugars.

Acarbose is an alpha-glucosidase inhibitor that slows down the break down of disaccharides and polysaccharides into monosaccharides. It is produced by strains of the genus actinoplanes and is used to treat patients with diabetes. It consists of an unsaturated aminocyclitol moiety (ring A), a deoxy ribose (ring B) and a normal maltose (rings C and D).

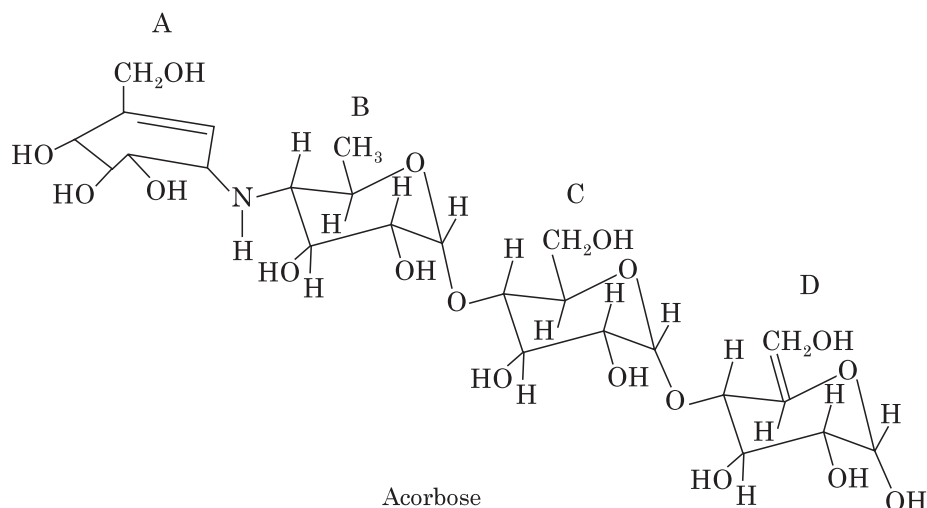

GSK-3 inhibitors. Glycogen synthase kinase 3 (GSK-3) was initially described as a key enzyme involved in glycogen metabolism, but now known to regulate a diverse array of cell functions. Two forms of the enzyme, GSK-3 α and GSK-3 β , have been identified.

GSK-3 in the 21st century emerged as one of the most attractive therapeutic target for the development of selective inhibitors as new promising drugs for unmet pathologies including inflammatory processes, neurological diseases, stroke, cancer and diabetes type II.

22

Thyroid and Antithyroid Drugs

INTRODUCTION

The thyroid is a small, butterfly-shaped gland located in front of the neck that produces hormones. These hormones that increase oxygen use in cells and stimulate vital processes in every part of the body. Thyroid epithelial cells of gland are responsible for synthesis of thyroid hormones. The epithelial cells are arranged in spheres called thyroid follicles. Follicles are filled with colloid, a proteinaceous depot of thyroid hormone precursor (thyroglobulin).

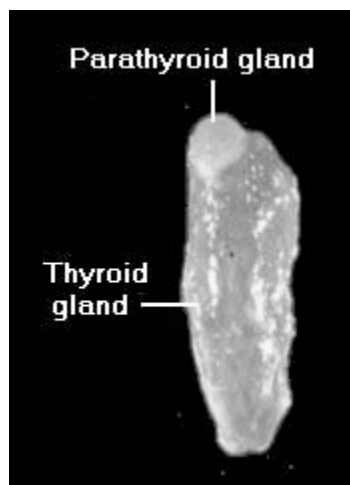

Thyroid gland

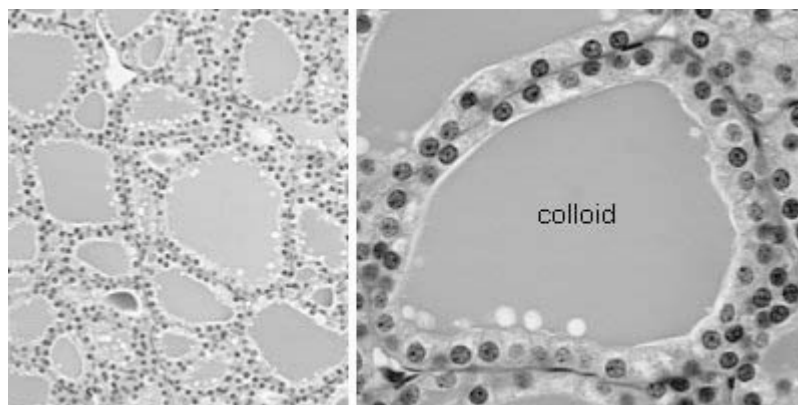

Thyroid follicles

PRODUCTION OF THYROID HORMONES

An understanding of the complex thyroid hormone process begins with *iodide*, a salt that is extracted from the blood and trapped by the thyroid gland.

1. **Tyrosines** are provided from a large glycoprotein scaffold called **thyroglobulin**, which is synthesized by thyroid epithelial cells and secreted into the lumen of the follicle—colloid is essentially a pool of thyroglobulin. A molecule of thyroglobulin contains 134 tyrosines, although only a handful of these are actually used to synthesize T4 (thyroxine) and T3 (triiodothyronine).
2. Iodide is converted to *iodine* in the thyroid gland. (Here, 80% of the body's iodine supply is then stored.) Iodine, in turn, is the raw material used in the manufacturing of *thyroxine* (T4), the key thyroid hormone.

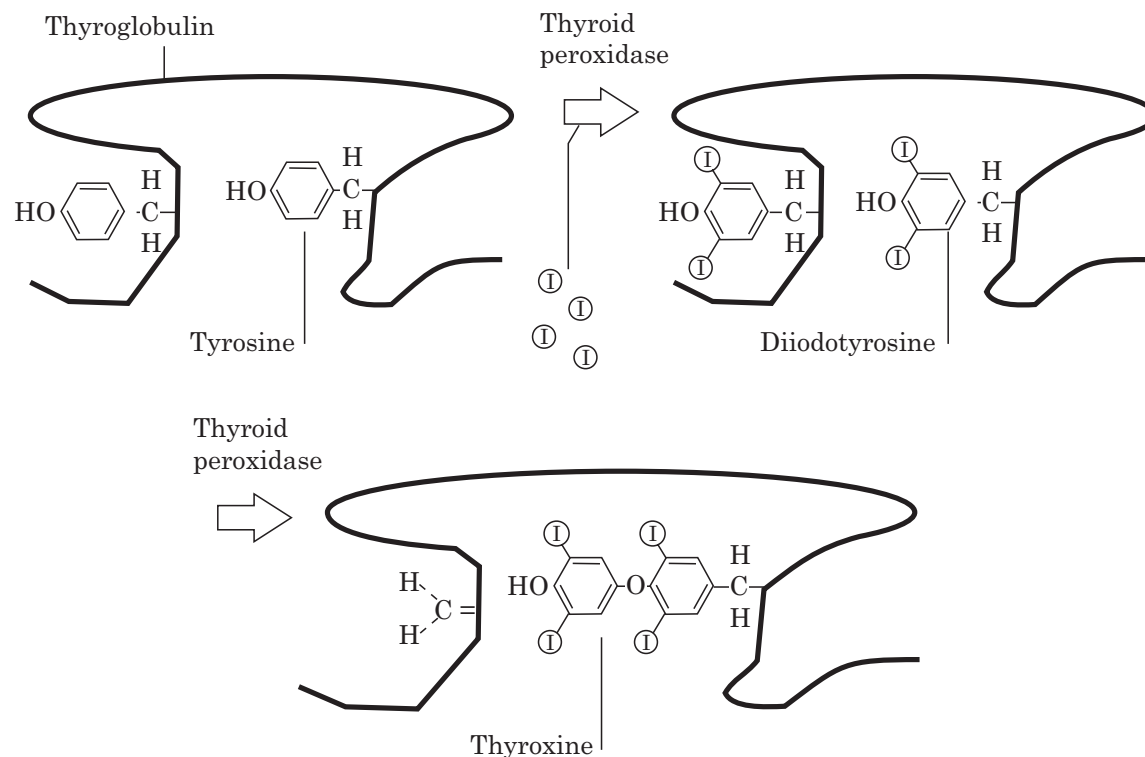

3. Thyroxine itself is converted into *triiodothyronine* (T3), which is the more biologically active thyroid hormone.
4. Once the T4 and T3 thyroid hormones are in circulation, a large fraction binds to other substances called thyroid hormone transport proteins, after which they become inactive.

- Two other important hormones in the process are *thyroid-stimulating hormone (TSH or thyrotropin)* and *thyrotropin-releasing hormone (TRH)*.
- TSH directly influences the whole process of iodine trapping and thyroid hormone production.
- TSH is secreted by the pituitary gland and monitored by TRH, which is produced in the hypothalamus gland (Both the pituitary and hypothalamus glands are located in the brain.).

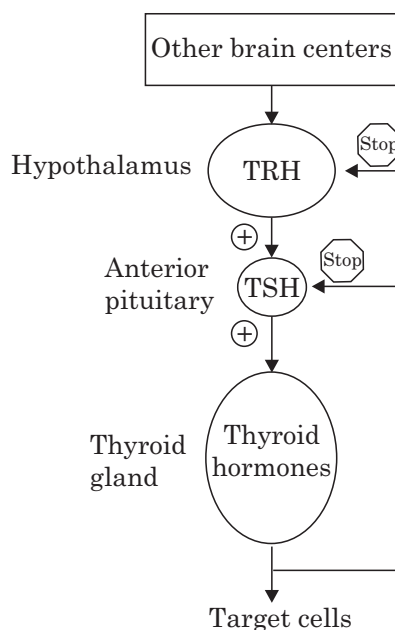

- When thyroxine levels drop even slightly, the pituitary gland goes into action to pump up secretion of TSH so that it can stimulate thyroxine production.

CHEMISTRY OF THYROID HORMONES

- Thyroid hormones are derivatives of the amino acid tyrosine bound covalently to iodine. The two principal thyroid hormones are :
 - thyroxine (known affectionately as T4 or L-3, 5, 3', 5'-tetraiodothyronine)
 - triiodotyronine (T3 or L-3, 5, 3'-triiodothyronine).

As shown in the following diagram, the thyroid hormones are basically two tyrosines linked together with the critical addition of iodine at three or four positions on the aromatic rings. The number and position of the iodines is important. Several other iodinated molecules are generated that have little or no biological activity; so called "reverse T3" (3, 3', 5'-T3) is such an example.

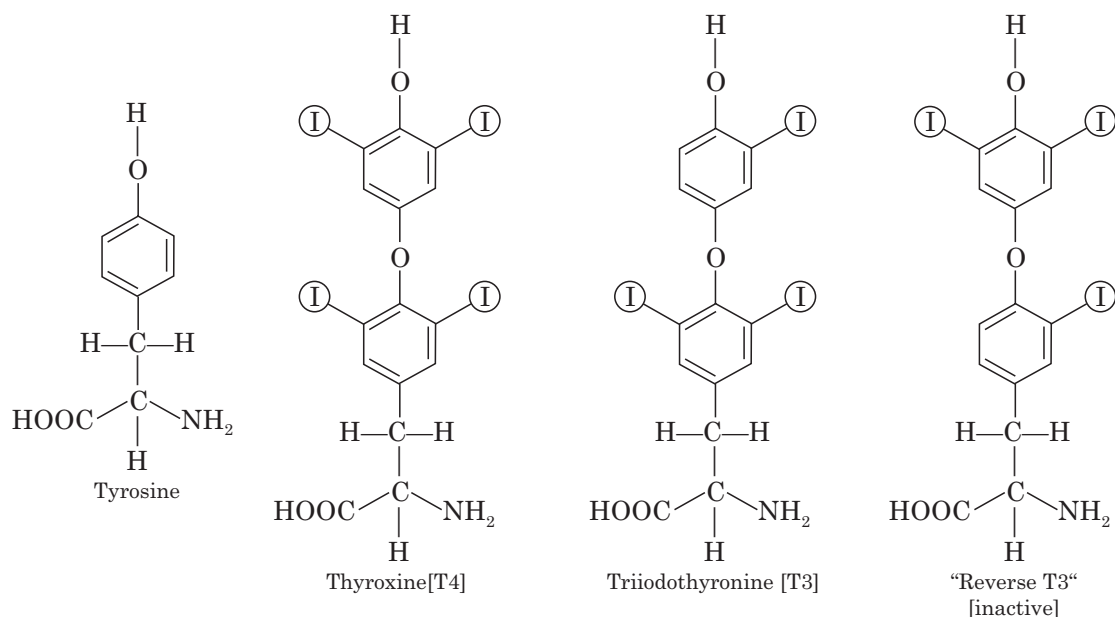

2. A large majority of the thyroid hormone secreted from the thyroid gland is T4, but T3 is the considerably more active hormone. Although some T3 is also secreted, the bulk of the T3 is derived by deiodination of T4 in peripheral tissues, especially liver and kidney. Deiodination of T4 also yields reverse T3, a molecule with no known metabolic activity.
3. Thyroid hormones are poorly soluble in water, and more than 99% of the T3 and T4 circulating in blood is bound to carrier proteins. The principle carrier of thyroid hormones is thyroxine-binding globulin, a glycoprotein synthesized in the liver. Two other carriers of import are transthyrin and albumin. Carrier proteins allow maintenance of a stable pool of thyroid hormones from which the active, free hormones are released for uptake by target cells.

PHYSIOLOGIC EFFECTS OF THYROID HORMONES

1. The thyroid hormones have a major impact on growth, use of energy, heat production, and infertility. They affect the use of vitamins, proteins, carbohydrates, fats, electrolytes, and water, and they regulate the immune response in the intestine. They can also alter the actions of other hormones and drugs. **It is likely that all cells in the body are targets for thyroid hormones.** While not strictly necessary for life, thyroid hormones have profound effects on many physiologic processes, such as development, growth and metabolism.
2. **Metabolism.** Thyroid hormones stimulate diverse metabolic activities of most tissues, leading to an increase in basal metabolic rate. One consequence of this activity is to increase body heat production.
3. **Growth.** Thyroid hormones are clearly necessary for normal growth in children and young animals, as evidenced by the growth-retardation observed in thyroid deficiency.

4. **Development.** The normal levels of thyroid hormone are essential to the development of the fetal and neonatal brain.
5. **Other Effects.** Thyroid hormones increases heart rate, cardiac contractility and cardiac output. They also alter mental state. Too little thyroid hormone, and the individual tends to feel mentally sluggish, while too much induces anxiety and nervousness.

THYROID DISEASE STATES

Disease is associated with both inadequate production and overproduction of thyroid hormones. Both types of disease are relatively common afflictions of man and animals.

1. Hypothyroidism is the result from any condition that results in thyroid hormone deficiency. Two well-known examples include :
 - (a) **Iodine deficiency.** Iodide is absolutely necessary for production of thyroid hormones; without adequate iodine intake, thyroid hormones cannot be synthesized.
 - (b) **Primary thyroid disease.** Inflammatory diseases of the thyroid that destroy parts of the gland are clearly an important cause of hypothyroidism.
2. Common symptoms of hypothyroidism arising after early childhood include lethargy, fatigue, cold-intolerance, weakness, hair loss and reproductive failure. If these signs are severe, the clinical condition is called **myxedema**. In the case of iodide deficiency, the thyroid becomes inordinately large and is called a **goiter**.
3. **The most severe and devastating form of hypothyroidism is seen in young children with congenital thyroid deficiency.** If that condition is not corrected by supplemental therapy soon after birth, the child will suffer from cretinism, a form of irreversible growth and mental retardation.
4. **Hyperthyroidism** results from secretion of thyroid hormones. In most species, this condition is less common than hypothyroidism. In humans the most common form of hyperthyroidism is Graves disease, an immune disease in which autoantibodies bind to and activate the thyroid-stimulating hormone receptor, leading to continual stimulation of thyroid hormone synthesis. Another interesting, but rare cause of hyperthyroidism is so-called **hamburger thyrotoxicosis**.

Common signs of hyperthyroidism are basically the opposite of those seen in hypothyroidism, and include nervousness, insomnia, high heart rate, eye disease and anxiety.

SPECIFIC THYROID DRUGS

Levothyroxine sodium (thyroxine sodium)

Chemistry. Levothyroxine is treatment of choice for hypothyroidism. This drug is a synthetic derivative of T₄ (thyroxine), and it normalizes blood levels of TSH, T₄, and T₃. Levothyroxine sodium is the levo isomer of thyroxine which is the primary secretion of thyroid gland. It occurs as an odorless, light yellow to buff-colored, tasteless, hygroscopic powder that is very slightly soluble in water and alcohol. The commercially available powders for injection also contain mannitol.

Levothyroxine is slowly assimilated by body organs, and it usually takes three to six weeks of treatment for improvement in symptoms in adults, although many patients feel better, and improved puffiness pulse.

Storage/Stability/Compatibility. Levothyroxine sodium preparations should be stored at room temperature in tight, light-resistant containers.

Pharmacology. Thyroid hormones affect the rate of many physiologic processes including: fat, protein and carbohydrate metabolism, increasing protein synthesis, increasing gluconeogenesis and promoting mobilization and utilization of glycogen stores. Thyroid hormones also increase oxygen consumption, body temperature, heart rate and cardiac output, blood volume, enzyme system activity, and growth and maturity. Thyroid hormone is particularly important for adequate development of the central nervous system. While the exact mechanisms how thyroid hormones exert their effects are not well understood, it is known that thyroid hormones (primarily triiodothyronine) act at the cellular level.

In humans, triiodothyronine (T₃) is the primary hormone responsible for activity. Approximately 80% of T₃ found in the peripheral tissues is derived from thyroxine (T₄) which is the principle hormone released by the thyroid.

Uses/Indications :

1. Levothyroxine sodium is indicated for the treatment of hypothyroidism in all species.
2. Liothyronine by intravenous injection is the treatment of choice in hypothyroid coma.
3. Adjunctive therapy includes intravenous fluids, hydrocortisone, and treatment of infection; assisted ventilation is often required.
4. T₄ is referred to as levothyroxine, or l-thyroxine, and T₃ as a liothyronine, or l-triiodothyronine, to highlight their derivation from the naturally occurring L-amino acid tyrosine, and not from racemic or the non-naturally occurring D-tyrosine.
5. Dessicated Thyroid or Thyroid Extract, it is indicated for the replacement or supplemental therapy in hypothyroidism, pituitary TSH suppressants (thyroid nodules, thyroiditis, multinodular goiter, thyroid cancer), thyrotoxicosis, and diagnostic suppression tests. Primary action is through T₃ content. Available in capsules or tablets.
6. **Levothyroxine Sodium.** L-Thyroxine Sodium, or T₄, is prescribed for replacement or supplemental therapy in hypothyroidism. Some clinicians consider levothyroxine the drug of choice for replacement therapy. Injection or tablets.
7. **Liothyronine Sodium.** Sodium L-Triiodothyronine or T₃ Sodium, it is indicated for replacement or supplemental therapy in hypothyroidism, management of nontoxic goiter, chronic lymphocytic thyroiditis, as an adjunct in thyrotoxicosis and as a diagnostic aid. Levothyroxine is recommended for chronic therapy. T₃ is also given to inhibit TSH dependent tumor growth through the negative feedback mechanism (T₃ downregulates TSH). Injection or tablets.

Structure/activity of thyroid hormone agonists

Hormone	Relative Activity
T ₄	1
T ₃	3-4
3, 5-diiodo-3'-isopropyl thyronine	7-15

ANTITHYROID DRUGS

Antithyroid drugs are used for hyperthyroidism either to prepare patients for thyroidectomy or for long-term management. They are used primarily to treat Graves' hyperthyroidism. These antagonists block the thyroid peroxidase which catalyzes both the incorporation of iodine into the tyrosine residues and the coupling of the outer phenol ring to the inner.

Mechanism. These drugs can inhibit synthesis of thyroid hormones by inhibiting the peroxidase enzyme, and may be immunomodulatory (anti-TSH receptor Ab are decreased and suppresser T-cell activity increased). Addition of thyroxine to regimens may increase remission rate.

Presently, two kinds of thioureylenes are used clinically to inhibit the thyroid peroxidase. One is based on thiouracil (PTU), the other is a mercaptoimidazole.

1. Propylthiouracil. Propylthiouracil (PTU) is the most commonly prescribed thiourelene. The mechanism of action is inhibition of the synthesis of thyroid hormones by blocking oxidation of iodine in the thyroid gland and by blocking synthesis of thyroxine and triiodothyronine. PTU is prescribed for the palliative treatment of hyperthyroidism as an adjunct to ameliorate hyperthyroidism in preparation for surgical treatment or radioactive iodine therapy and in the management of thyrotoxic crisis. The use of antithyroid thiomides is effective for all age groups, but expense, compliance, and monitoring problems make them undesirable compared to use of radioactive iodine.

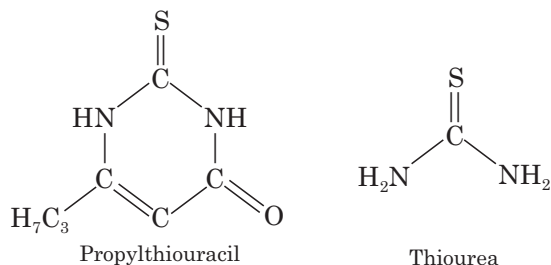

Propylthiouracil is given in a dose of 200 to 400 mg daily in adults and this dose is maintained until the patient becomes euthyroid; the dose may then be gradually maintenance dose of 50 to 150 reduced to a mg daily.

2. Methimazole. Methimazole is prescribed to return the hyperthyroid patient to a normal metabolic state prior to thyroidectomy, and to control thyrotoxic crisis that may accompany thyroidectomy. Methimazole inhibits the synthesis of thyroid hormones by blocking

the oxidation of iodine in the thyroid gland and by blocking the ability of iodine to be incorporated into tyrosine to form T_4 or T_3 .

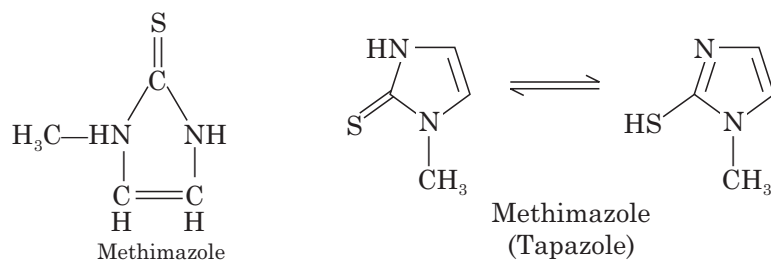

3. Carbimazole. Carbimazole is the most commonly used drug. It act primarily by interfering with the synthesis of thyroid hormones.

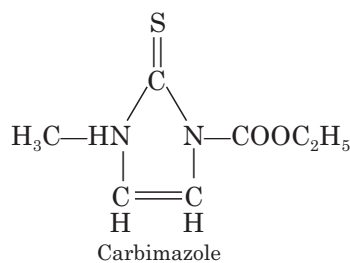

Carbimazole is given in a dose of 15 to 40 mg daily; occasionally a larger dose may be required.

Practice Questions **(Essay and Short Questions)**

CHAPTERS 1, 2 & 3

1. Define medicinal chemistry? Explain how medicinal chemistry has interrelationship with other subjects?
2. What are drugs? Explain various routes of drug administration?
3. What are receptors? Discuss various receptors and receptor theories with examples?
4. What are drugs? Explain with examples how drugs act?
5. What are drug-receptor interactions? Explain different types of binding forces exist in drug-receptor interactions with examples?
6. Explain different mechanisms of drug actions?
7. Write notes on different sites of drug action?
8. Discuss the importance of hydrogen bonding, partition coefficient and chelation in relation to biological activity?
9. Enumerate the various physicochemical properties that modulate biological activity and explain any two of them in detail?
10. Enumerate the physicochemical properties that influence biological activity. Give a detailed account of any two of them?
11. Discuss the influence of :
12. (a) Bioisosterism (b) Hydrogen bonding
(c) Ionization (d) Stereoisomerism on biological activity.
13. Discuss the suitable examples the importance of the following in relation to biological activity of drugs :
14. (i) Optical isomerism (ii) Partition coefficient.
15. What is bioisosterism? How is it useful in the design of drugs?
16. Giving suitable examples, show how different types of isomerism affects the biological activity of drugs?
17. How does protein binding of drugs affect the biological activity of therapeutic agents?
18. With the help of appropriate examples, elucidate how different physicochemical properties of drug molecules are related to their biological activity?
19. Explain the role of pKa in the biological activity of drugs?

20. "Biological activity of a drug does not simply depend on its chemical structure but also on its physicochemical properties." Illustrate the above statement with suitable examples?
21. Discuss citing suitable examples how complexation, protein binding and partition coefficient affect biological activity of drugs?
22. What is partition coefficient?
23. What is molar refractivity?
24. What is bioisosterism?
25. What are isosters?

CHAPTER 4

26. What are prodrugs? Describe the prodrug concept with examples?
27. How do prodrugs differ from soft drugs?
28. Enumerate the ideal properties of an ideal prodrug?
29. What principles are utilized in prodrug design for taste masking and odor improvement of drugs?
30. Classify prodrugs according to the functional group? Write about the prodrugs of carboxylic acids and carbonyl compounds with examples?
31. How can the prodrug design approach be utilized for controlled delivery?

CHAPTER 5

32. What is the major function of metabolic reaction?
33. What are various sites of drug metabolism in the body? Why is liver considered as the major site for metabolism?
34. Classify the chemical pathways of drug metabolism?
35. What are phase 1 reactions? Why are phase 1 reactions classed as fictionalization reactions?
36. Discuss the following metabolic reactions with examples :
37. (a) Acetylation (b) Glucuronidation
(c) *o*-Dealkylation (d) N-Dealkylation
(e) Sulfation.

CHAPTER 6

38. Give classification of general anesthetics and write their mode of action?
39. What are general anesthetics? Give an account of them?
40. What are general anesthetics? Classify them and describe them briefly? Enumerate various characteristic features of ideal general anesthetic?

41. Write about Chemistry, properties and clinical uses of:
- (a) Methoxyflurane
 - (b) Enflurane
 - (c) Isoflurane.
42. Discuss the chemistry of :
- (a) Cyclopropane
 - (b) Nitrous oxide
 - (c) Chloroform
 - (d) Halothane
 - (e) Propandid.
43. Write notes on :
- (a) Methohexital
 - (b) Propofol
 - (c) Ketamine
 - (d) Isoflurane.
44. How do you synthesize :
- (a) Chloroform from bleaching powder
 - (b) Halothane from trichloroethylene
 - (c) Methohexital from 2-chloro-3-pentyne
 - (d) Ketamine from 0-chlorobenzonitrile.

CHAPTER 7

45. Discuss the SAR, mode of action and uses of Barbiturates. Outline the synthesis of phenobarbitone?
46. Give chemical classification of sedatives and hypnotics with structures of atleast two drugs from each class?
47. Outline the general scheme of synthesis of barbiturates. Discuss the SAR of barbiturates?
48. Expail the development of Barbiturates?
49. What are non-barbiturates? Describe the chemistry and synthesis of Glutethimide, methypylone?
50. What are sedatives and hypnotics? How do they differ from antianxiety agents?
51. Write the SAR and mode of action of barbiturates?
52. Give an account of the malonyl urea derivatives used as sedatives. Outline the synthesis and clinical uses of phenobarbitone and thiopentone?
53. Describe the synthesis and clinical uses of one typical drug from :
- (a) A sulfur containing sedative
 - (b) A pyrimidine derivative.
54. A piperidinedione derivative.
55. Quinazoline derivative having hypnotic activity.
56. Describe how do you synthesize the following hypnotic-sedative drugs :
- (a) Chloral hydrate
 - (b) Meprobamate
 - (c) Ethchlorvynol
 - (d) Triazolam.

57. Discuss the chemistry and uses of :
- | | |
|--------------------|---------------------|
| (a) Diazepam | (b) Prazepam |
| (c) Secobarbitone | (d) Butobarbitone |
| (e) Cyclobarbitone | (f) Pentobarbitone. |

CHAPTER 8

58. Discuss the general structural features of drugs associated with anticonvulsant activity. Write the mode of action, uses and synthesis of phenytoin and valproic acid?
59. Write briefly on "Anticonvulsants"?
60. Bring out the similarities in the chemistry of different classes of anticonvulsant drugs?
61. Describe the synthesis and clinical uses of phenytoin, troxidone, ethosuximide and carbamazepine?
62. What are Hydantoin? Write about the chemistry of hydantoin
63. Trace out the common chemical features of different classes of antiepileptics? Outline the synthesis and give the clinical uses of phenytoin, troxidone, ethosuximide and carbamazepine.
64. How do you synthesize:
- | | |
|------------------|-------------------|
| (a) Methoin | (b) Trimethadione |
| (c) Phensuximide | (d) Ethosuximide. |
65. Describe synthetic schemes of :
- | | |
|-------------------|-------------------|
| (a) Diazepam | (b) Clonazepam |
| (c) Carbamazepine | (d) Methsuximide. |

CHAPTER 9

66. Discuss SAR of tricyclic antidepressants. Enumerate MAO inhibitors giving the structures of any four drugs?
67. Write notes on Butyrophenone antipsychotics? Outline the synthesis of Haloperidol?
68. Give two examples each with structures of benzodiazepines used as sedatives, anxiolytics and anticonvulsants?
69. Write the mode of action and synthesis of :
70. (a) Imipramine (b) Levadopa
(c) Haloperidol.
71. Classify antipsychotics giving two examples with structures for each class. Write the SAR and mode of action of phenothiazine antipsychotics. Outline the synthesis of chlorpromazine?
72. What are major tranquilizers? Classify them with examples and discuss their mode of action?

73. Discuss with suitable examples the SAR of phenothiazines?
74. Write short notes on Antidepressants?
75. What are antidepressants? Briefly write the mode of action of tricyclic antidepressants and MAO inhibitors?
76. What are antipsychotic agents? Classify them with examples and write briefly their mode of action?
77. Write the synthesis and mode of action on :
 - (a) Chlordiazepoxide
 - (b) Chlorprothixene
 - (c) Amitriptylene
 - (d) Isocarboxazide
 - (e) Pargyline.
78. Write the Dopamine hypothesis in psychosis?
79. Enumerate the different groups of drugs used in the treatment of depressive disorders?
80. Give a brief account of the chemistry of :
81. (a) Butyrophenone anti-psychotics (b) Benzodiazepine anti-psychotics.
82. Classify phenothiazine derivatives pharmacologically? Outline the synthesis and medicinal uses of chlorpromazine, haloperidol and thiothixene?
83. Write about the chemistry of tricyclic antidepressant drugs?
84. Outline the synthesis and mention the clinical uses of imipramine, iproniazide and tranlycypromine?

CHAPTER 10

85. Give classification of cholinergic drugs with examples and write the SAR, mode of action and uses. Outline the synthesis of any one anticholinesterases?
86. Write a note on anticholinesterases.
87. Give an account of cholinergic and anticholinesterase agents and outline the synthesis of any two such drugs?
88. What are neurotransmitters? Classify neurotransmitters with examples? Describe the synthesis and release of acetylcholine?
89. Outline the synthesis and describe the clinical uses of a cholinergic agonist, which is an *m*-hydroxy aniline derivative.
90. Give a comprehensive account of parasympathomimetic drugs covering their classification, SAR and mode of action? Describe the synthesis and clinical uses of three such drugs?
91. Give an account of the drugs used as cholinergic and anticholinesterase agents?
92. What are the differences between cholinergic agonists and antagonists? Discuss the chemistry of any two drugs from each category?
93. What are antispasmodic and antiulcer drugs? Give an account of the chemistry of synthetic cholinergic blocking agents?

- 94.** What do you understand by cholinergic and anticholinesterase agents?
- 95.** Describe the synthesis and clinical uses of :
- (a) Pralidoxime (b) Homatropine
(c) Trihexyl phenidyl (d) Tropicamide
(e) Dicyclomin (f) Piperidolate.
- 96.** Give a brief account on chemistry of :
- (a) Pyridostigmine (b) Atropine
(c) Propantheline bromide (d) Biperidine.
- 97.** Write notes on :
- (a) Reversible anticholinesterases (b) Cholinomimetic alkaloids
(c) Choline esters.

CHAPTERS 11 & 12

- 98.** Classify adrenergic drugs with examples and write their SAR?
- 99.** Classify sympathomimetic agents and give their mode of action, uses and structure activity relationships?
- 100.** Write the structure, mode of action and uses of metoclopramide?
- 101.** Enumerate the biosynthesis of Noradrenaline and write the uses of sympathomimetics?
- 102.** Write the synthesis of Propranolol and Tolazoline?
- 103.** Outline the chemical classification of adrenergic drugs? Discuss their mechanism of action? Comment on the essential structural features required for the optimum activity of such drugs?
- 104.** Discuss the chemistry and SAR of adrenergic drugs? Write about synthesis and clinical uses of:
- (a) Adrenaline (b) Isoproterenol
(c) Terbutaline.
- 105.** Outline the synthesis of amphetamine?
- 106.** What are general structural requirements for adrenoreceptor agonists? Describe the mode of action of such drugs?
- 107.** Give the synthesis and medicinal uses of dichloroisoproterenol, ephedrine and salbutamol?
- 108.** Give a comprehensive account of sympathomimetic drugs covering their classification, SAR and mode of action?
- 109.** Describe the synthetic procedure of any two important sympatholytic agents?
- 110.** Write about synthesis, mechanism of action and clinical uses of :
- (a) Nylidrin (b) Hydroxyamphetamine
(c) Naphazoline.

111. Give your analytical and synthetic evidences to establish the structure of Ephedrine?
112. What are indirectly acting adrenergic drugs? Discuss the chemistry, synthesis and clinical uses of amphetamine, cyclopentamine, naphazoline, xylometazoline and ephedrine?
113. How do you prepare :
- (a) Metaraminol (b) Propranolol
(c) Dichloroisoproterenol (d) Butoxamine.
114. What are adrenergic blockers? Discuss the chemistry and SAR of β -adrenergic blocking agents with examples?
115. Give a detailed account on chemistry of :
- (a) Ergot alkaloids (b) Selective α -receptor stimulants
(c) Selective β_2 -adrenergic stimulants.

CHAPTER 13

116. Write notes on muscle relaxants?
117. Write the synthesis, mode of action and uses methocarbamol?
118. What are muscle relaxants? Write about mechanism of action on muscle relaxants
119. Explain the synthesis and clinical uses of carisoprodol and chlorphenesin?
120. Write notes on :
- (a) Dantrolene (b) Baclofen.

CHAPTER 14

121. Define H_1 -receptor blockers? Give the classification by giving suitable examples?
122. Write the structure activity relationships of H_1 -receptor blockers?
123. What are histamine receptors? Write a brief account on histamine receptors?
124. What are antihistamines? Write the differences between H_1 receptor blockers and H_2 -receptor blockers?
125. Outline the synthesis of any two important H_1 -receptor blockers?
126. Write the structure, mode of action and uses of Ranitidine and Terfenadine?
127. Classify with examples the antihistaminic agents and discuss their general mode of action and uses?
128. What are antihistamines? Classify them with examples and write their mode of action?
129. Outline the synthesis and uses of :
- (a) Diphenhydramine (b) Chlorpheniramine
(c) Chlorpromazine (d) Cimetidine.
130. Classify antiallergenic agents giving examples? Write the synthesis of two compounds selecting from each class?

131. Discuss the mode of action of H₁-receptor antagonists?
132. Write the chemical name and synthesis of one H₁-receptor antagonist from each of the following groups :
- (a) Aminoalkyl ethers (b) Ethylenediamines
(c) Phenothiazines.
133. Outline the synthesis and describe the clinical uses of H₁-receptor antagonist having an aminoalkyl ether structure?
134. How do you prepare :
- (a) Carbinoxamine (b) Bromodiphenhydramine
(c) Pyrilamine.
135. Write the names and structures of H₁-receptor antagonists possessing pyridine and piperidine moieties?

CHAPTERS 15, 16 & 17

136. Discuss the SAR of opioid analgesics and indicate the structural similarity among the various chemical classes of this group?
137. What are anti-tussive agents? Furnish the names and structures of three narcotic and three non-narcotic antitussive agents?
138. What are opioid analgesics? Describe the chemistry of various morphine derivatives?
139. What are narcotic antagonists? Explain the chemistry of any two narcotic antagonists?
140. What are opiate receptors? Discuss the biochemical action of opium derivatives? Describe the chemistry of Morphine?
141. What are peripherally modified derivatives of morphine? Enumerate various peripherally modified derivatives of morphine with their structures and uses?
142. What are synthetic morphine derivatives? Discuss the synthesis and clinical uses of any two synthetic derivatives?
143. What are synthetic analgesics? Explain the synthesis and uses of methadone and ethoheptazine?
144. How do you prepare :
- (a) Nalorphine (b) Levallorphan.
145. Classify antitussives with examples? How do you prepare caramiphen?
146. Write notes on :
- (a) Benzonatate (b) Noscapine
(c) Dextromethorphan.
147. Write notes on :
- (a) Nalorphine (b) Codeine
(c) Naltrexone.

CHAPTER 18

148. Classify non-steroidal anti-inflammatory agents giving structures of two drugs for each class. Discuss the mode of action and SAR of aryl alcanoic acids. Outline the synthesis of Ibuprofen?
149. Write notes on Antipyretics?
150. Classify analgesics and antipyretics with suitable examples?
151. Briefly write the mode of action, and structure activity relation of Analgesics and Antipyretics?
152. Write the synthesis of mefenamic acid?
153. What are analgesics and antipyretics. Write the mode of action and limitations of salicylates?
154. Outline the synthesis of :
- | | |
|--------------------|---------------------|
| (a) Paracetamol | (b) Ibuprofen |
| (c) Diclofenac | (d) Oxyphenbutazone |
| (e) Indomethacin | (f) Piroxicam |
| (g) Phenylbutazone | (h) Naproxen. |
155. Write the SAR of N-arylanthranilic acids?
156. Write the mode of action of NSAIDS?
157. Define non-steroidal antinflammatory drugs? Classify them according to their chemical moiety? Give details of indolyl and aryl acetic acid derivatives?
158. Write the synthesis and mechanism of action of Naproxen?
159. Write abot SAR of indole acetic acid derivatives?
160. How do you prepare Piroxicam and Sulindac?
161. Given an account of chemistry of :
- | | |
|-------------------|--------------------------------|
| (a) Salicylates | (b) Propionic acid derivatives |
| (c) Anthranilates | (d) Oxicams. |
162. What are COX-2 selective inhibitors? Enumerate the advantages of COX-2 inhibitors over COX-1 inhibitors? Write the structures and clinical uses of any two COX-2 selective inhibitors?
163. What are NSAIDS? Discuss the general chemical properties of NSAIDS with examples?
164. Write notes on :
- | | |
|--------------|--------------------------------|
| (a) Naproxen | (b) COX-2 selective inhibitors |
| (c) Sulindac | (d) Mefenamic acid. |

CHAPTER 19

165. Write notes on local anesthetics?
166. Write the structure, mode of action and uses of Lignocaine and benzocaine?

189. Write notes on hypoglycemic agents?
190. Describe the synthesis, uses and mode of action of tolbutamide?
191. Write a detailed note on oral hypoglycemic agents?
192. What are oral hypoglycemic agents? Discuss the chemistry and SAR of sulphonyl urea derivatives?
193. What is the source of insulin? Why insulin cannot be given orally? Discuss the chemistry of any four hypoglycemic agents belong to different classes?
194. Write a detailed account on some newer oral antidiabetic agents?
195. Classify hypoglycemic agents giving the names of agents of each class. Describe structure and biosynthesis of insulin?
196. Write about synthesis and mechanism of action of Glipizide and Phenformin?
197. Write notes on :
 - (a) Glibenclamide
 - (b) Glipizide
 - (c) GSK-3 inhibitors
 - (d) Thiazolidinedione derivatives.

CHAPTER 22

198. What are thyroid hormones? Discuss the production and chemistry of thyroid hormones?
199. What are thyroid drugs? Write a note on chemistry of levothyroxine?
200. What are antithyroid drugs? Discuss the mechanism of action and chemistry of carbimazole, propyl thiouracil, and methimazole?
201. Write notes on Antithyroid drugs?

Objective Questions

1. The chemical name 7-chloro-1,3-dihydro-1-methyl-5-phenyl-1,4-benzodiazepine-2-one belongs to _____

Ans: Diazepam.

2. Which physicochemical property influence drug transport characteristics i.e., the way drugs reach the site of action from the site of application?

Ans: Partition coefficient.

3. Hansch observed that the relationship between Log P and activity is _____

Ans: Parabolic.

4. What parameters are used to understand the behaviour of drug molecules?

Ans: pK_a and LogP.

5. Which important factor influences drug-receptor interactions?

Ans: Hydrogen bonding.

6. Hydantoin is a cyclic _____

Ans: Monoacylurea.

7. Hydantoin possesses _____ heterocyclic system.

Ans: Imidazolidine-2,4-dione.

8. Chemically phenytoin is _____

Ans: 5,5-diphenylimidazolidine-2,4-dione.

9. A + B phenytoin. Write structures of A and B.

Ans: A: *o*-bromodiphenylacetylurea, B: alcoholic ammonia.

10. Phenytoin stabilizes neuronal membrane by decreasing _____

Ans: Sodium channel flux.

11. _____ is a pyridine analogue of neostigmine, which is used for reversal of neuromuscular block.

Ans: Pyridostigmine.

12. Pyridostigmine bromide can be synthesized from _____ by condensation with dimethyl carbamoyl chloride.

Ans: 3-hydroxy-1-methyl pyridinium bromide.

13. Pyridostigmine is a potent _____ of acetylcholinesterase.

Ans: reversible inhibitor.

14. _____ consists of two neostigmine molecules linked by a chain of 10 methylene groups.
Ans: Demecarium.
15. Ambenonium is used to treat _____.
Ans: myasthenia gravis.
16. Ecothiopate is a long acting _____ anticholinesterase drug.
Ans: irreversible.
17. _____ isomer of atropine is 250 times more active
Ans: *l*-isomer
18. The chemical name of glycopyrrolate is _____.
Ans: 3-hydroxy-1,1-dimethyl pyrrolidinium bromide- α -cyclopentyl mandelate.
19. Histamine is present mostly within the storage granule of _____.
Ans: mast cells and basophils.
20. Histamine is chemically _____.
Ans: 2-(4-imidazolyl)ethylamine.
21. Histamine is synthesized from _____.
Ans: Histidine.
22. Which cyclooxygenase enzyme is responsible for house keeping functions of prostaglandins?
Ans: COX-1.
23. Which cyclooxygenase is responsible for inflammatory processes mediated by prostaglandins?
Ans: COX-2.
24. NSAIDS inhibit both _____ and _____.
Ans: COX-1, COX-2.
25. Celecoxib is an selective _____ inhibitor.
Ans: COX-2.
26. Antipyretic activity of NSAIDS results from inhibition of _____.
Ans: Prostaglandin E2.
27. Generally NSAIDS structurally consist of an _____ moiety attached to a planar aromatic functionality.
Ans: Acidic.
28. What is the NSAIDS general structure?

Ans:

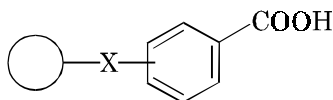

NSAID General Structure

29. Magnesium salicylate is prepared by mixing of _____ with sufficient quantity of _____ in isopropranol and water mixture.
Ans: Salicylic acid, magnesium oxide.
30. Chemically salicylamide is _____
Ans: *o*-hydroxy benzamide.
31. Aluminium aspirin is prepared by mixing of _____ with water and _____ at 65°C.
Ans: Aluminium hydroxide gel, acetyl salicylic acid.
32. Calcium aspirin is a calcium salt of _____
Ans: Acetyl salicylic acid.
33. Chemically flufenisol is _____
Ans: Acetyl-5-(4-fluorophenyl) salicylic acid.
34. Which enantiomes of profens is the more potent cyclooxygenase inhibitor?
Ans: S (+)-enantiomer.
35. Most of the synthetic routes to prepare ibuprofen begin with _____
Ans: Isobutyl benzene.
36. Indomethacin posses _____ nucleus.
Ans: Indole.
37. Piroxicam and meloxicam are characterized by the _____ heterocycle.
Ans: 4-hydroxy benzothiazine.
38. Chemically antipyrine is _____
Ans: 2,3-dimethyl-1-phenyl-3-pyrazolin-5-one.
39. Chemically aminopyrine is _____
Ans: 2,3-dimethyl-4-dimethyl amino-1-phenyl-3-pyrazolin-5-one.
40. Mephenytoin chemically is _____
Ans: 5-ethyl-3-methyl-5-phenyl hydantoin.
41. Mephenytoin is synthesized from _____
Ans: Cyanophenyl acetamide.
42. Oxazolidine-2,4-dione is analogous to _____ differs in having _____ atom at position 1 instead of NH.
Ans: Hydantoin, oxygen.
43. Trimethadione is an _____ derivative.
Ans: Oxazolidinedione.
44. Chemically trimethadione is _____
Ans: 3, 5, 5-trimethyloxazolidine-2, 4-dione.
45. Chemically phensuximide is _____
Ans: 2-phenylsuccinimide.

46. _____ and _____ starting materials are used to synthesize ethosuximide.
Ans: 2-butanone, ethycyanoacetate.
47. Carbamazepine is an _____ derivative possess _____ nucleus.
Ans: Azepine, dibenzazepine.
48. _____ is released at both pre and post ganglionic synapses in parasympathetic system.
Ans: Acetylcholine.
49. _____ enzyme catalyses the reaction between acetyl coenzyme A and choline.
Ans: α -cholineacetylase.
50. _____ and _____ are acetylcholine receptors.
Ans: muscarinic, nicotine.
51. Choline esters stimulate _____ receptors.
Ans: muscarinic.
52. _____ is a synthetic derivative of choline.
Ans: Bethamechol.
53. Carbachol is an ester of _____.
Ans: Carbamic acid.
54. Methacholine is used to treat _____ and _____.
Ans: Raynaud's syndrome and glaucoma.
55. Write some examples of cholinomimetic alkaloids?
Ans: Pilocarpine, Arecoline, Muscarine.
56. Which site of acetylcholinesterase enzyme binds with the quaternary nitrogen of acetylcholine?
Ans: Anionic site of acetylcholinesterase.
57. Acetylcholinesterase inhibitors have been used clinically in the treatment of _____.
Ans: Myasthenia gravis.
58. Glucuronidation is catalysed by various _____.
Ans: microsomal glucuronyl transferases.
59. Analgesic activity is mediated by _____ receptors in CNS.
Ans: opiate.
60. _____ group is an important structural feature for analgesic activity in morphine.
Ans: 3-hydroxyl.
61. Second-generation antihistamines bind only to _____.
Ans: Peripheral H1-receptors.
62. H2 receptor blockers are used to treat _____.
Ans: Gastric ulcers.

63. _____ moiety is present in famotidine.
Ans: Imidazole.
64. Adrenergic nerves release _____, _____ and _____ neurotransmitters.
Ans: Norepinephrine, epinephrine, dopamine.
65. _____ and _____ enzymes are important in the biotransformations of catecholamines.
Ans: Monoaminoxidase, Catechol-O-methyl transferase.
66. Norepinephrine activates primarily _____ receptors and epinephrine activates primarily _____ receptors.
Ans: α , β .
67. All catecholamines possess _____ nucleus.
Ans: O-Hydroxybenzene or Catechol.
68. Noncatecholamines possess _____ ring and an _____ side chain.
Ans: Benzene, ethylamine.
69. What is the general structure of piperazine antihistamine.

Ans:

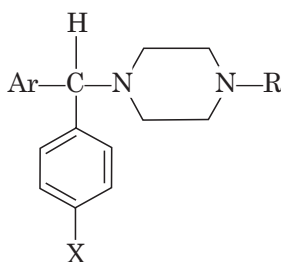

70. Cyclizine is a _____ derivative.
Ans: Piperazine.
71. Cyclizine is prepared by reaction of _____ with _____.
Ans: Benzhydryl chloride, N-methylpiperazine.
72. Cyproheptadine is a _____ antagonist _____ antagonist.
Ans: Histamine H₁-receptor, serotonin.
73. Azatadine is chemically related to _____.
Ans: Cyproheptadine.
74. Antazoline is a _____ derivative.
Ans: Imidazoline.
75. Diphenylpyraline is synthesized by refluxing the mixture of _____ and _____.
Ans: 1-methyl-4-piperidinol, benzhydryl bromide.
76. Ebastine is a potent, long acting _____.
Ans: Antihistamine.

77. Propylhexedrine is used as _____ and _____
Ans: Nasal decongestant, adrenergic agent.
78. Cyclopentamine is a _____ possessing indirectly acting _____ activity.
Ans: Non-catecholamine, adrenoreceptor agonistic.
79. Chemically naphazoline is _____
Ans: 2-(1-naphthylmethyl)-2-imidazoline.
80. Xylometazoline is prepared by heating _____ with ethylenediamine monochloride at 200°C.
Ans: (4-tert-butyl-2,6-dimethylphenyl) acetonitrile.
81. Ephedrine has _____ asymmetric centers.
Ans: Two.
82. Chemically metaraminol is _____
Ans: 3-hydroxyphenyl isopropanolamine.
83. Mephenteramine is used as a _____
Ans: Parenteral Vasopressor.
84. Adrenoreceptor blocks _____ the effects of catecholamines.
Ans: Competitively.
85. _____ are similar to β -agonists.
Ans: β -Blockers.
86. Incorporation of _____ group into the molecule between the aromatic ring and the ethylamine side chain provides β -blocking activity.
Ans: $-\text{OCH}_2$.
87. Naphthol on reaction with epichlorhydrin provides the glycidic ether which on treatment with isopropylamine gives _____
Ans: Propranolol.
88. Propranolol is an effective _____
Ans: Antihypertensive agent.
89. Hydroxy propranolol is a short acting _____
Ans: β -antagonist.
90. Timolol has been approved for _____
Ans: Hypertension.
91. Metoprolol is _____
Ans: β_1 -selective antagonist.
92. The potassium-sparing diuretics act on _____
Ans: Collecting tubule and collecting duct.
93. High ceiling diuretics are commonly referred as _____
Ans: Loop diuretics.

- 94.** Benzothiazides directly inhibit sodium and chloride reabsorption at _____
Ans: Distal convoluted tubule.
- 95.** Local anesthetics block _____ of the nerve membrane to make the conduction of the nerve impulse impossible.
Ans: Depolarization.
- 96.** Local anesthetics have pKs between _____ and _____ which permits them to exist in both ionized and non-ionised forms at physiologic pH.
Ans: 7.7, 9.3.
- 97.** Cyclomethycaine is prepared by condensation of _____ with _____
Ans: 4-cyclohexyl benzoic acid, piperocaine hydrochloride.
- 98.** Cinchocaine is prepared from _____
Ans: 2-hydroxy-4-quinoline carboxylic acid.
- 99.** The insulin receptor is composed of _____ subunits and linked by _____
Ans: Two α , two β , disulphide bonds.
- 100.** Chlorpropamide is a derivative of _____
Ans: Benzene sulphonamide.
- 101.** Glibenclamide is prepared from _____ and _____
Ans: 3-chloro-2-methoxy benzoylchloride, 2-amino ethyl benzenesulphonamide.
- 102.** Glipizide is prepared from _____ and _____
Ans: 5-methylpiperazine-2-carboxylic acid, 4-(2-aminoethyl) benzene sulphonamide.
- 103.** Baclofen is a _____
Ans: Central skeletal muscle relaxant.
- 104.** Baclofen inhibits both _____ and _____ reflexes at spinal level.
Ans: monosynaptic, polysynaptic.
- 105.** The chemical name of carisoprodol is _____
Ans: N-isopropyl-2-methyl-2-propyl-1,3-propanediol dicarbamate.
- 106.** Chlorphenesin is synthesized by condensation of _____ with _____
Ans: 4-chlorophenol, 3-chloro-1,2-propanediol.
- 107.** The chemical name of methocarbamol is _____
Ans: β -(-O-methoxyphenoxy)-1,2-propanediol-1-carbamate.
- 108.** _____ acts directly on skeletal muscle to inhibit muscle contraction.
Ans: Dantrolene.
- 109.** Cyclazocine is a _____ derivative.
Ans: Benzomorphan.
- 110.** Naltrexone possesses _____ at the piperidine nitrogen of oxymorphone moiety.
Ans: Cyclopropyl methyl.

111. _____ is a non-opioid synthetic antitussive.

Ans: Benzonatate.

112. The commercially available COX-2 inhibitors can be structurally characterized as _____

Ans: diaryl-5-membered heterocycles.

113. Celecoxib has a central _____ ring and two adjacent _____ substituents.

Ans: Pyrazole, phenyl.

114. Rofecoxib has a central _____ ring.

Ans: Furanose.

115. Valdecoxib is an aryl _____ derivative.

Ans: Sulfonamide.

116. Histamine carries its message to a large number of cells by attaching to a _____ on the cells surfaces.

Ans: Special receptors.

117. How many kinds of histamine receptors are there?

Ans: Two kinds, they are H₁ and H₂. However H₃ also identified based on laboratory animal experiments.

118. Histamine H₁-antagonists should have _____ nitrogen for maximum antihistaminic activity.

Ans: 3°.

119. What is the general structure of H₁-Histamine antagonists).

Ans:
$$\text{Ar}-\text{X}^*-\text{[CH}_2\text{-CH}_2\text{]}_n-\text{N} \begin{matrix} \diagup \text{R} \\ \diagdown \text{R} \end{matrix}$$

120. Carbimazole is administered as _____

Ans: Antithyroid.

121. Primidone is used to treat _____

Ans: Hypnosis sedation and epilepsy.

122. Heroin is a _____ derivative of morphine.

Ans: Diacetyl.

123. Salindac is obtained from _____

Ans: 4-fluorobenzaldehyde.

124. Condensation of _____ and _____ gives barbiturates.

Ans: Malonic acid, urea.

125. The activity of benzothiazide diuretics is _____ by reduction of the double bond.

Ans: Increased.

126. A piperidine dione derivative used as hypnotic and sedative is _____

Ans: Glutethimide.

127. _____ group is present in prazepam but not in diazepam.
Ans: cyclopropyl methyl.
128. Hydrolysis of atropine barium hydroxide gives _____ and _____.
Ans: tropic acid, tropine.
130. A α_2 -adrenergic agonist is _____.
Ans: Clonidine.
131. A local anesthetic derived from xylgnas _____.
Ans: Lignocaine.
132. An oral hypoglycemic agent belonging to sulfonyl urea derivative is _____.
Ans: Tolbutamide.
133. Oxyphenonium bromide is classified as _____.
Ans: Parasympatholytic.
134. Methyldopa centrally acts as _____.
Ans: Antihypertensive.
135. Acetylation of both 3 and 6-OH groups yields _____.
Ans: Heroin.
136. Reduction of codeine's 7,8-double bond _____ activity relative to codeine.
Ans: Increases.
137. Replacement of morphine's N-methyl group with an allyl group results _____.
Ans: Naloxone.
138. _____ resembles narcotics with respect to its mechanism of action.
Ans: Propoxyphene.
139. _____ is a novel drug possessing of both opioid agonistic and antagonistic properties.
Ans: Pentazocine.
140. _____ is the raw material for the synthesis of thyroxine (Tu).
Ans: Iodine.
141. Which is the key thyroid hormone?
Ans: Thyroxine.
142. Which thyroid hormone is more biologically active?
Ans: Triiodothyronine.
143. _____ is treatment of choice for hypothyroidism.
Ans: Levothyroxine.
144. Chlorpheniramine maleate is a product of _____.
Ans: Alkylamine.
145. An antianxiety agent having a 1,4-benzodiazepine ring is known as _____.
Ans: Diazepam.

146. Spiranolactone acts as a competitive inhibitor of _____
Ans: Aldosterone.
147. Furosemide and ethacrynic acid acts mainly on _____
Ans: Loop of henle of nephron.
148. Pilocarpine is extracted from the leaves of _____
Ans: Pilocarpus jaborandi.
149. Acetylation of _____ gives paracetamol.
Ans: Para-Aminophenol.
150. The chemical name of sodium valproate is _____
Ans: Sodium-2-propylpentanoate
151. An antihistamine belongs to piperazine derivative is _____
Ans: Meclizine.
152. Ethacrynic acid is a _____ derivative.
Ans: Phenoxyacetic acid.
153. A synthetic anticholinergic agent is _____
Ans: Mepenzolate or glycopyrrolate.
154. Acetazolamide contains _____ heterocyclic ring.
Ans: Thiadiazole.
155. Amethocaine hydrochloride is used as _____
Ans: Local anesthetic.
156. Pralidoxime acts as an antidote in _____ poisoning.
Ans: Organophosphates.
157. Chemically halothane is _____
Ans: 2-bromo-2-chloro-1,1,1-trifluoroethane.
158. A+B _____ procaine hydrochloride write structure of A and B.
Ans: A: 2-chloroethyl 4-aminobenzoate; B: diethyl amine.
159. By which mechanism local anesthetic block nerve conduction?
Ans: Depolarisation.
160. Semisynthetic analogue of atropine is _____
Ans: Homatropine.
161. Pethidine is derived from _____
Ans: Piperidine.
162. Morphine on distillation with zinc yields _____
Ans: Pnenauthrene.
163. Exposure of paraldehyde to light gives _____
Ans: Acetaldehyde.

- 164.** Methylation of morphine with methylating agent gives _____
Ans: Codeine.
- 165.** A derivative of succinamide used as a drug is _____
Ans: Ethosuccinamide.
- 166.** Carbachol contains _____ group instead of acetyl in alcohol.
Ans: Carbamoyl.
- 167.** A carbonic anhydrase inhibitor is _____
Ans: Acetazolamide.
- 168.** Glibenclamide is used to treat _____
Ans: Diabetes mellitus.
- 169.** An example of i.v. general anesthetic is _____
Ans: Thiopental sodium.
- 170.** An MAO inhibitor used in the treatment of hypertension is _____
Ans: Pargyline.
- 171.** Propranolol is obtained from _____
Ans: Arylpropanolamine.
- 172.** Chemical name of amylobarbitone is _____
Ans: Ethyl-4-isopentylbarbituric acid.
- 173.** The common name of 5-ethyl-5-phenylbarbituric acid is _____
Ans: Phenobarbitone.
- 174.** Haloperidol tranquiliser is the derivable of _____
Ans: Butyrophenone.
- 175.** Glibenclamide contains _____ moiety.
Ans: Benzenesulphonyl urea.
- 176.** Chemical name of atenolol is _____
Ans: 1-P-Amidomethylphenoxy-3-isopropylamino-2-propranolol.
- 177.** Ergot alkaloids are derivatives of _____
Ans: Lysergic acid.
- 178.** Quinazolines are selective _____
Ans: α_1 -Adrenergic competitive blockers.
- 179.** _____ was the first known selective α_1 -blocker.
Ans: Prazosin.
- 180.** Phentolamine and tolazoline are substituted _____
Ans: Imidazolines.
- 181.** Ephedrine is isolated from _____
Ans: Ephedra gerardiana.

- 182.** Isoprenaline is derived from _____
Ans: Isopropylaminoethanol.
- 183.** Promethazine turns to _____ colour on exposure to light.
Ans: Blue.
- 184.** Frusemide and nitrofurantoin are _____ containing heterocyclics.
Ans: Furan.
- 185.** Leperamide is used to treat _____
Ans: Diarrhoea.
- 186.** Morphine mimics the endogenous neurotransmitter _____
Ans: Enkephalins.
- 187.** Xylometazoline HCl is taken as _____
Ans: Nasal decongestant.
- 188.** Thyroxine possesses _____ iodine group.
Ans: Four.
- 189.** Chlorpropamide is a product of _____
Ans: Sulphonylureas.
- 190.** An antihistaminic drug of amino alkyl ethers group is _____ drug.
Ans: Diphenhydramine.
- 191.** Substitution of hydroxyl group of catechol nucleus by other groups reduces _____ activity and abolishes _____ activity.
Ans: α , β .
- 192.** Chemical name of dopamine is _____
Ans: 3, 4-Dihydroxyphenylethylamine.
- 193.** Isoproterenol is a synthetic catecholamine acting almost exclusively at _____ receptors.
Ans: β .
- 194.** _____ is the most potent of catecholamines.
Ans: Isoproterenol (Isoprenaline).
- 195.** Phenylephrine differs from adrenaline only by lacking the _____ group on the benzene ring.
Ans: 4-Hydroxy.
- 196.** Phenylephrine is synthesized by condensation of _____ with _____ followed by catalytic reduction.
Ans: 3-chloroacetylphenyl, methylamine.
- 197.** Dobutamine is a selective _____ receptor agonist.
Ans: β_1 .

198. Terbutaline is prepared by catalytic reduction of _____

Ans: 2-(tert-butylamino)-3',5'-dihydroxyacetophenone.

199. Isoetharine has _____ and _____ properties.

Ans: α_1 and β -antagonistic.

200. Ritodrine is a short acting _____ stimulant.

Ans: β_2 .

201. Metaproterenol is prepared by condensation of _____ with isopropylamine followed by reduction.

Ans: 2-chloro-3',5'-dihydroxy acetophenone.

202. Amphetamine is an _____ amine.

Ans: Indirect-acting sympathomimetic.

203. Amphetamine is synthesized by reductive amination of _____ with ammonia and hydrogen.

Ans: Phenylacetone.

204. Chemically propylhexedrine is _____

Ans: 1-Cyclohexyl-2-methylaminopropane.

205. Pheniramine possess _____ nucleus.

Ans: Pyridine.

206. Chemical name of chlorpheniramine is _____

Ans: 3-(4-chlorophenyl)-3-(2-pyridyl) propyldimethylamine.

207. What is the general structure of phenothiazine antihistamines?

Ans:

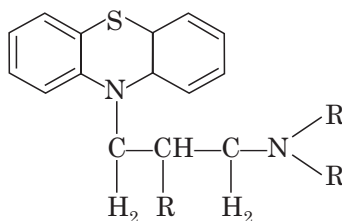

208. Trimeprazine is a _____ derivative.

Ans: Phenothiazine.

209. Triprolidine is a _____ derivative and possess _____ and _____ moieties.

Ans: Pyrrolidine, pyrrolidine, pyridine.

210. Promethazine possess _____ nucleus.

Ans: Phenothiazine.

211. Promethazine is prepared by condensation of _____ with _____ in presence of sodamide.

Ans: Phenothiazine, 2-(N-dimethylamino)-1-chloropropane.

212. Methdilazine is a _____ derivative.

Ans: Phenothiazine.

213. What is the fundamental structure of ethylenediamine derivatives of H₁-antagonists?

Ans:

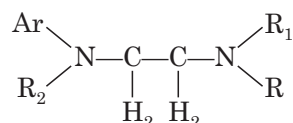

214. Clemastine is an _____ derivative possessing of _____ nucleus.

Ans: Ethylenediamine, pyrrolidine.

215. Methapyrilene is a _____ derivative with _____ nucleus.

Ans: Ethylenediamine, pyridine.

216. All propyl amine antihistamines are _____ compounds.

Ans: Chiral.

217. Chemically Triclofos sodium is _____

Ans: Sodium 2,2,2-trichloroethyl hydrogen orthophosphate.

218. Methimazole is taken in the prophylaxis of _____

Ans: Hyperthyroidism.

219. Insulin is secreted by _____ of islets of langerhans of pancreas.

Ans: β-cells.

220. Pethidine is derived from _____

Ans: Phenylpiperidine.

221. A hydrazine derivative belongs to MAO inhibitor category is _____

Ans: Iproniazide.

222. _____ of morphine with a methylating agent gives Codeine.

Ans: Methylation.

223. Morphine produces blue colour with FeCl₃ sodium due to the presence of _____

Ans: Phenolic hydroxyl group.

224. An example of I.V. general anesthetic is Thiopentone.

225. Carbochol contains _____ instead of acetyl in acetylcholine.

Ans: Carbamoyl group.

226. A hormone isolated from thyroid gland is _____

Ans: Thyroxine.

REFERENCES

1. J. N. Delgado and W.A. Remers, Wilson and Gisvold's Textbook of Organic Medicinal and Pharmaceutical Chemistry, Lippincott's, Philadelphia.
2. W.O. Foye, T.L. Lemke and D.A. Williams, Principles of Medicinal Chemistry, Williams and Wilkins, Pennsylvania.
3. G. Thomas, Chemistry for Pharmacy and Life Sciences, Prentice-Hall, New York.
4. M. E. Wolff, Burger's Medicinal Chemistry, Wiley-Interscience, New York.
5. A.R. Gennaro, Ed., Remington's Pharmaceutical Sciences, Mack Publications, Pennsylvania.
6. A. Kar, Medicinal Chemistry, New Age Publishers, New Delhi.
7. British Pharmacopoeia.
8. A. G. Gilman, L.S. Goodman, the Pharmacological Basis of Therapeutics, New York.
9. Marcel Dekkar., New York, Concepts in Drug Metabolism, B. Testa and P. Jenner.,
10. V.N. Gogte, Profile in Drug Synthesis, Gokul Publishers, Mumbai.
11. Burger's Medicinal Chemistry and Drug Discovery, Sixth Edition, Volume 6: Nervous System Agents Edited by Donald J. Abraham, John Wiley and Sons, Inc.
12. United States Pharmacopoeia.
13. Emanuel, M.B, Histamine and the Antiallergic Antihistamine: A History of their Discoveries. Clinical and Experimental Allergy 29: 1-11, 1999.
14. Rama Rao Nadendla, Pharmaceutical Organic Chemistry (Heterocyclics and Natural Products) by Vallabh Prakasan, New Delhi.
15. Role of Pharmacokinetics and Metabolism in Drug Discovery and Development :jiunn h. lin a and anthony y. h. lu, Department of Drug Metabolism, Merck Research Laboratories, West Point, Pennsylvania, Pharmacological Reviews Vol. 49, no. 4
16. <http://www.elmhurst.edu/~chm>
17. Indian Pharmacopoeia.
18. The British Pharmaceutical Codex
19. The Merck Index
20. The Pharmaceutical Journal, Volume, 268, April, 2002, 539.
21. E.A. Barnard, Trends Biochem. Sci., 1992, 17, 368.
22. G. Carpenter, Annu. Rev. Biochem., 1987, 56, 881.
23. S.R. Coughlin, Curr. Opinion Cell Biol., 1994, 6, 191.
24. R.M. Evans, Science, 1988, 240, 889.
25. T. Kenakin, Pharmacological Analysis of Drug Receptor Interactions, Raven Press, New York, 1993.
26. Clarke's Isolation and identification of drugs, pharmaceutical press, London.
27. C. Hansch, Quantitative dtructure-activity Relationship in drug design, In: drug design, vol I, chap. 2 (Ed., E. J. Ariens) academic press, New York.

28. J. G. Topliss, Quantitative structure-activity relationships of drugs, Academic press New York.
29. http://www.ionsource.com/tutorial/metabolism/drug_metabolism.htm - Small Molecule Drug Metabolism.
30. Progress in Medicinal Chemistry G.P. Ellis and G.B. West, Butterworth, London.
32. Bentley and Driver's Pharmaceutical Chemistry.
33. D. Lednicer and L.A. Mitscher, The Organic Chemistry of Drug Synthesis: John Wiley and Sons, New York.
34. P. Parimoo, A text Book of Medicinal Chemistry, CBS Publishers, New Delhi.
35. Rama Rao Nadendla, Principles of Pharmaceutical Organic Chemistry (Revised and Enlarged) by Macmillan India Private Limited.

Index

A

Acetohexamide, 275
Acetazolamide, 261, 262
Acetohexamide, 50
Acetylation, 50
Acetylcholine, 122, 123, 124
Adrenaline, 155
Adrenergic agonists, 155
Adrenergic drugs, 149
Adrenergic receptors, 151
Aldosterone antagonists, 269
Allergies, 184
Alprazolam, 75
Aluminium aspirin, 236
Amethocaine, 255
Amiloride, 268
Aminoalkylether derivatives, 189
Aminopyrine, 246
Amitriptyline, 93
Amphetamine, 163
Anilides, 246
Antazoline, 206
Anthranilates, 242
Antianxiety agents, 83
Anticholinergic drugs, 138, 140
Anticonvulsants, 102
Antidepressant agents, 88
Antihistamines, 184, 187
Antipsychotic drugs, 77
Antipyrine, 246
Antitussives, 229
Anxiolytics, 83

Apomorphine, 223
Aryloxypropanolamines, 171
Aspirin, 236
Azatadine, 204
Acorbose, 281
Antithyroid drugs, 288

B

Baclofen, 181
Barbitone, 69
Barbiturates, 62
Barbituric acid, 63
Bendroflumethiazide, 266, 267
Benzocaine, 254
Benzodiazepines, 84
Benzonatate, 230
Benzotropinemesylate, 146
Bethanechol, 128
Biguanides, 278
Biososterism, 28
Biperidine hydrochloride, 145
Bromodiphen hydramine, 191
Brompheniramine, 197
Buclizine, 203
Bumetanide, 263
Bupivacaine, 258
Buprenorphine, 281, 220
Butobarbitone, 69
Butorphanol, 223
Butoxamine, 174
Butyrophenones, 82
Beudro flumethiazide, 266
Benzoic acid derivatives, 280

C

Calcium acetylsalicylate, 236
Caramiphen, 231
Carbachol, 128
Carbamazepine, 114
Carbimazole, 289
Carbinoxamine, 190
Carbomazepine, 114
Carbonic anhydrase inhibitors, 260
Carisoprodol, 181
Catecholamines, 150
Celecoxib, 247
Cetirizine, 208
Chloral hydrate, 72
Chlorthalidone, 266
Chlorazepate, 76
Chloroform, 56
Chlorphenesin, 181
Chlorpheniramine, 196
Chlorpromazine, 79
Chlorpropamide, 275, 276
Chlorthiazide, 266, 268
Chlorcyclizine, 201
Choline esters, 126
Cholinergic drugs, 126
Cholinomimetic alkaloids, 130
Cimetidine, 209
Cinchocaine, 256
Clemastine, 193
Clindinium bromide, 147
Clomipramine, 93
Clonazepam, 111
Clozapine, 95
Cocaine, 252
Codeine, 214, 229
Complexation, 24
Conjugation reactions, 48
Cough, 229
Cyclizine, 201
Cyclobarbitone, 67

Cyclomethycaine, 257, 258
Cyclopentamine, 164
Cyclopentolate hydrochloride, 148
Cyclopropane, 54
Cyclooxygenase, 232
Cyclooxygenase inhibitors, 233, 247
Cyclozocine, 228
Cyproheptadine, 204
Cytochrome P450 Reductase, 50

D

Dantrolene, 182
Dealkylation, 44
Demecarium, 135
Deoxymorphine, 213
Desipramine, 94
Dextromethorphan, 230
Diacetylmorphine, 214
Diazepam, 112, 86
Dibenamine, 179
Dibenzocycloheptenes, 203
Dichloroisoproterenol, 173
Dichlorphenamide, 262
Dicyclomine, 147
Diethylether, 55
Dihydrocodeine, 216
Dimenhydrinate, 191
Dimethindene, 205
Diphepanil, 145
Diphenhydramine, 189
Diphenoxylate, 223
Diphenylpyraline, 206
Dipyrrone, 246
Dissociation constants, 18
Diuretics, 259
Dobutamine, 159
Dopamine, 157
Doxylamine, 192
Drug metabolism, 41
Drug shape, 24

E

Ebastine, 207
Ecothiopate, 136
Edrophonium, 134
Enflurane, 57
Ephedrine, 167
Epilepsy, 102
Epinephrine, 155
Ergot alkaloids, 175
Ethacrynic acid, 263, 264
Ethchloroynol, 73
Ethoheptazine, 222
Ethosuximide, 109
Ethylchloride, 54
Ethylenediamines, 192
Ethylmorphine, 213
Etorphine, 218

F

Fentanyl, 220
Fexofenadine, 208
Flufenisol, 237
Fluoxetine, 96
Flurazepam, 74
Fluvoxamine, 97
Frusemide, 263, 265
Functionalized aminoacids, 119

G

Gabapentin, 118
General anesthesia, 52
General anesthetics, 52
Glibenclamide, 277
Glipizide, 278
Glucuronidation, 48
Glutethimide, 70
Glycerine, 262
Glycopyrrolate, 141
GSK-3 inhibitors, 281

H

Haloalkylamines, 178
Haloperidol, 83
Halothane, 55
Heroin, 214
Histamine, 185
Homatropine, 140
Hydantoins, 104
Hydrochlorthiazide, 268
Hydrogen bonding, 20
Hydrolysis, 49
Hydromorphone, 215
Hydroxyamphetamine, 163
Hydroxylation, 43
Hydroxypropranolol, 172
Hyoscyamine, 141
Hyoscine, 40
Hydroflumethiazide, 266
Hypoglycemic agents, 270

I

Ibuprofen, 238
Imidazolines, 176
Imipramine, 90, 94
Indomethacin, 240
Insulin, 271
Ionization of drugs, 23
Iproniazid, 89
Isoetharine, 161
Isoflurane, 57
Isoflurophate, 136
Isoprenaline, 157
Isopropamideiodide, 143
Isoproterenol, 157
Isosorbide, 262
Indepamide, 266

K

Ketamine, 60
Ketorolac, 242

Labetalol, 174
Lamotrigine, 117
Levallorphan, 226, 227
Levothyroxine, 286
Lidocaine, 255
Lignocaine, 255
Local anesthetics, 249
Loop diuretics, 263
Loperamide, 221
Loratidine, 208
Lorazepam, 85

M

Magnesium salicylate, 235
Malathion, 136
Meclizine, 202
Mefenamic acid, 243
Meloxicam, 244
Mepenzolate, 146
Meperidine, 219
Mephenteramine, 169
Mephenytoin, 105
Meproamate, 73
Metabolic reactions, 42
Metoprolol, 172
Metaproterenol, 162
Metaraminol, 169
Metformin, 279
Methacholine, 129
Methadone, 220
Methapyrilene, 194
Methaqualone, 71
Methazodamide, 262
Methimazole, 288
Methocarbamol, 182
Methohexital, 58
Methoxamine, 162
Methoxyflrane, 57
Methsuximide, 110
Methylphenobarbitone, 67
Methyprylone, 71

Monoamineoxidase inhibitors, 99
Morphine, 212
Morphine derivatives, 212
Muscarinic antagonists, 138
Muscarinic receptors, 126
Muscle relaxants, 180
Muscle spasm, 180
Metolazone, 266

N

Nalbuphine, 217
Nalmefene, 217
Nalorphine, 226
Naloxone, 217, 225
Naltrexone, 217, 227
Naphazoline, 265
Naproxen, 239
Narcotic analgesics, 211
Narcotic antagonists, 225
Narcotics, 211, 225
Nefopam, 211
Neostigmine, 132
Neurochemistry, 122
Neurotransmitters, 122
Nicotine, 125
Nicotinic receptors, 125
Nitrous oxide, 54
Nonbarbiturates, 70
Non-steroidal anti-inflammatory agents, 232
Noradrenaline, 157
Norepinephrine, 157
Normorphine, 217
Nortriptyline, 94
Noscapine, 231
Nylidrin, 161

O

Opiate receptors, 212
Opium alkaloids, 211
Organophosphates, 135
Orphenadrine citrate, 148

- Osmotic diuretics, 262
Oxazolidinediones, 106
Oxidation, 44
Oxycodone, 216
Oxymetazoline, 167
Oxymorphone, 215
Oxyphenbutazone, 245
Oxyphencyclimine, 143
Paracetamol, 247
Paraldehyde, 72
Paramethadione, 107
Parasympathetic nervous system, 121
Parathion, 137
Partitioncoefficient, 16
Pentazocine, 224
Pentobarbitone, 67
Pethidine, 219
Phenacemide, 115
Phenacetin, 247
Phenelzine, 100
Phenformin, 279
Phenindamine, 205
Pheniramine, 195
Phenobarbitone, 103
Phenothiazines, 198, 78
Phenoxybenzamine, 178
Phensuximide, 108
Phentolamine, 177
Phenylbutazone, 245
Phenylephrine, 158
Phenylsalicylate, 235
Phenytoin, 104
Pholcodeine, 213
Physico-chemical properties, 14
Physostigmine, 132
Pilocarpine, 130
Piperazines, 200
Piperidolate, 146
Piroxicam, 244
Poldinemethylsulfate, 145
Pioglitazone, 280
Pentazocine, 224
Potassium-sparing diuretics, 268
Pralidoxime, 137
Prazepom, 75
Prazosin, 176
Primidone, 115
Procaine, 255
Prochlorperazine, 80
Procyclidine hydrochloride, 145
Prodrugs, 31
Promazine, 81
Promethazine, 199
Pronethalol, 173
Prontosil, 34
Propanidid, 59
Propantheline bromide, 142
Propionicacid derivatives, 237
Propofol, 60
Propoxyphene, 222
Propylamine derivatives, 195
Propylhexedrine, 164
Propylthiouracil, 288
Protein binding, 27
Psychoactive drugs, 77
Psychotropic drugs, 77
Pyridostigmine, 133
Pyrilamine, 193
- Q**
- Quinalbarbitone, 70
Quinazolines, 176
Quinethazone, 266
- R**
- Ranitidine, 209
Reductive reactions, 47
Ritodrine, 162
Rofecoxib, 248
Rosiglitazone, 280
Repaglinide, 281

S

Salicylamide, 235
Salicylates, 234
Sedative-hypnotics, 61
Selective serotonin re-uptake inhibitors, 95
Selegiline, 100
Serotonin, 95
Sertraline, 98
Skeletal muscle relaxants, 180
Sodium salicylate, 235
Soft drugs, 40
Solubility, 14
Spiranolactone, 269
Succinimides, 108
Sulfate conjugation, 49
Sulfonyl ureas, 274
Sulindac, 241
Surfaceactivity, 26
Sympathetic nervous system, 122

T

Temazepam, 75
Terbutaline, 160
Tetrahydrozoline, 165
Thebaines, 218
Thiazides, 265
Thiopentone, 58
Thonzylamine, 194
Thyroid drugs, 282
Thyroid hormones, 282, 283
Thyroxine sodium, 286

Timolol, 172
Tolazoline, 177
Tolbutamide, 275, 276, 277
Torsemide, 263
Tranlycypromine, 100
Triazolam, 76
Trichloroethylene, 56
Triclofos sodium, 73
Tricyclic antidepressants, 91
Trifluoperazine, 80
Trifluopromazine, 81
Trihexyphenidyl hydrochloride, 142
Trimeprazine, 198
Trimethadione, 107
Triprolidine, 197
Tropicamide, 144
Triamterene, 268
Thiazolidinones, 280

U

Urea, 262

V

Valdecoxib, 248
Valproic acid, 116
Venlafaxine, 98
Vigabatrin, 118

X

Xylometazoline, 166